

Bible Story 201

**THE PROMISE
OF THE
HOLY SPIRIT**

JOHN 7:37-39

201. THE PROMISE OF THE HOLY SPIRIT (JOHN 7:37-39)



“He that believeth on me, as the scripture hath said, out of his belly shall flow rivers of living water.
(But this spoke to him of the Spirit, which they that believe on him should receive: for the Holy
Ghost was not yet *given*; because that Jesus was not yet glorified.)”

JOHN 7:38-39

201. THE PROMISE OF THE HOLY SPIRIT

(JOHN 7:37-39)

MEMORY VERSE:

"On the last day, that great day of the feast, Jesus stood and cried out, saying, 'If anyone thirsts, let him come to Me and drink.' " JOHN 7:37

TRUE OR FALSE:

1. "...Jesus stood and cried out, saying, 'If anyone thirsts, let him come to Me and drink.' "
JOHN 7:37

TRUE OR FALSE

CIRCLE THE CORRECT WORD:

2. "He who believes in Me, as the Scripture has said, out of his (**LAKE, HEART**) will flow rivers of living water." JOHN 7:38

TRUE OR FALSE:

3. "...But this He spoke concerning the Spirit, whom those believing in Him would receive..." JOHN 7:39

TRUE OR FALSE

CIRCLE THE CORRECT WORD(S):

4. "...for the Holy Spirit (**WAS, WAS NOT**) yet given..." JOHN 7:39

UNDERLINE THE CORRECT WORD:

5. "...because Jesus was not yet..." JOHN 7:39
- a. needed
 - b. glorified
 - c. known

201. THE PROMISE OF THE HOLY SPIRIT

(JOHN 7:37-39)

C P G U L V P M R P P A F E P
 P Z N G W U R E C E I V E Z K
 R V W F C I C H E V Z G L P R
 F U Y Y A T I R I P S Y L O H
 M D Z I R B E L I E V E S E E
 E W E F G E B Y B G S S K U S
 T E R B Z L T Y V Y T A I U N
 L E U L S P O A T Q V U S V A
 M B T A D H C R W D G E Q F I
 E D P E E N B M I G J K M I P
 Z V I A G S P B O F N S S O Q
 I N R Z P C R P J O I I S U C
 I T C T H I R S T S W E V H F
 D P S C C N E R Q O D Y D I R
 Z Y K N I R D Y L K K B O I L

BELIEVES
 COME
 DRINK
 GLORIFIED

HEART
 HOLY SPIRIT
 JESUS
 LIVING WATER

RECEIVE
 SCRIPTURE
 THIRSTS

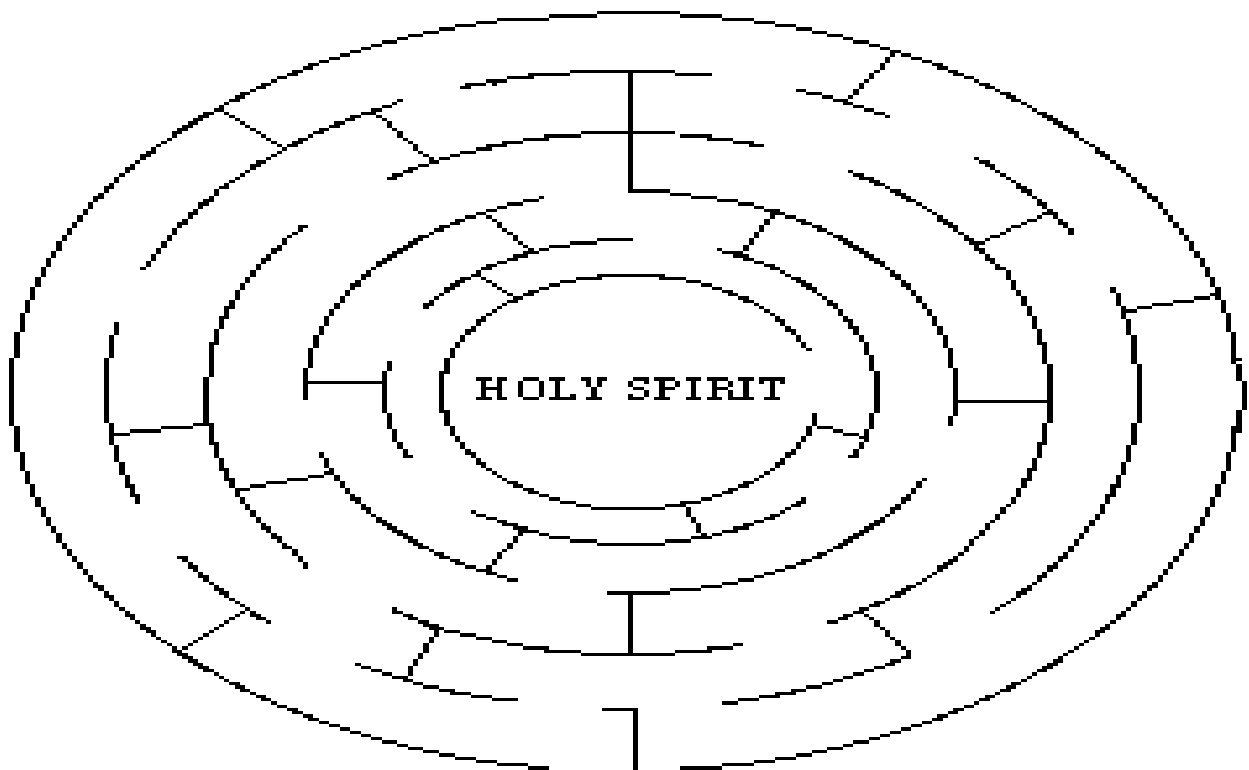

201. THE PROMISE OF THE HOLY SPIRIT

(JOHN 7:37-39)

MEMORY VERSE:

"On the last day, that great day of the feast, Jesus stood and cried out, saying, 'If anyone thirsts, let him come to Me and drink.' " JOHN 7:37

TRUE OR FALSE:

1. "...Jesus stood and cried out, saying, 'If anyone thirsts, let him come to Me and drink.' " JOHN 7:37
TRUE OR FALSE

FILL IN THE BLANK:

2. "He who believes in Me, as the Scripture has said, out of his _____ will flow rivers of living water." JOHN 7:38

TRUE OR FALSE:

3. "...But this He spoke concerning the Spirit, whom those believing in Him would receive..." JOHN 7:39
TRUE OR FALSE

FILL IN THE BLANKS:

4. "...for the _____ was not yet given..." JOHN 7:39

UNDERLINE THE CORRECT WORD:

5. "...because Jesus was not yet..." JOHN 7:39
- a. needed
 - b. glorified
 - c. known

201. THE PROMISE OF THE HOLY SPIRIT

(JOHN 7:37-39)

M M B T W V U B E L W E G V E I I B N I Q V O I D Q I U I B
 J G O N D P D L O B L O Q Q T N R U R N A K B Z P V A L S R U
 C U N Y O Z F L R U G J O L P O K B F J Y T F Z Z E N O B V
 M U C B K S H N I L S S T C T N B Q Y T J G L V R D D K V D
 Y O B T J M G M Y Y Z Z H M L T B K V L P H Q Q K B G S S E
 S V B P R B U Z S L R N K G Z V F L Y N A Q P Q Q E I W J D H
 O V I N G A Q S E H O W W K T B A E M J V Z S U G Z Z F R M
 J R F U N A E V R B J R W M T K Y S F E V I E C E R A B F U
 I F A L Z K J H U K L I E P M C B Z P O T T L S I F E R N N
 M W W N P I V M T K L O B T S E C R N I P W U D V L K C V C
 O P B Z Q Y Q O P B A V I E A U M L I M G V D E I A Z R V A
 Y W B H L T D N I D G R L I M W U U D N F M Z E M K E L B J
 D V Y R A F D G R O I M R P H Z G C L S R W V B K Q A S W K
 V G K A L Z D I C P H G Q L V B A N R Z R E O B N S H P J R
 U J Y A L B V C S F G D S E Y E K E I D S M N U I W V E L L
 H T T J M C V Y Y N N T C P L Q V R G V O V U Q R Y L F E C
 S F P Y S S L N D Q S O R K L I I K R C I Z O J D U V Z D B
 S G S G O O D E Y R W T H S R A L G A A C L B A V F R L C B
 O J J H H L K B I R B C N N M L O W F B T Q T D O I E V V B
 V W V S A S L H B K W U N U E B Z T W F N B L I V E R O H U
 Z J D E L N T P O D B V V W J F I D V D E I F I R O L G H J
 D H T Q K P S L J F V N G S L H J C B L B U R O O O T L A B
 C G T M N P H L C H B V R C D V Z V Q I U W F B F Z Q Z H Z
 B B Q B M M R R V L H M K T Z E T S J H Q D F E M E S J B D
 O A F L G N P O G D C U E P P L T B C V D Y Z O J R W P E D
 P F N C G Q P J M I O M Z M E C I K A M Y N R N Y I S E U H
 O H F B T Q R Z W I O O L S B J J Y S E C P F R T Y J N D I
 R P T B E H B F H C S M M D L I I F B Y Z P M L N M R R J G
 J T H Y L V N J H P Y E I Q I T J D W Y Y H C L H S Q N T A
 Y Q D U S Z G F B M K M V H A B B Q D S S Q R S U S E J Q F

BELIEVES
 COME
 DRINK
 GLORIFIED
 HEART

HOLY SPIRIT
 JESUS
 LIVING WATER
 PROMISE

RECEIVE
 RIVERS
 SCRIPTURE
 THIRSTS

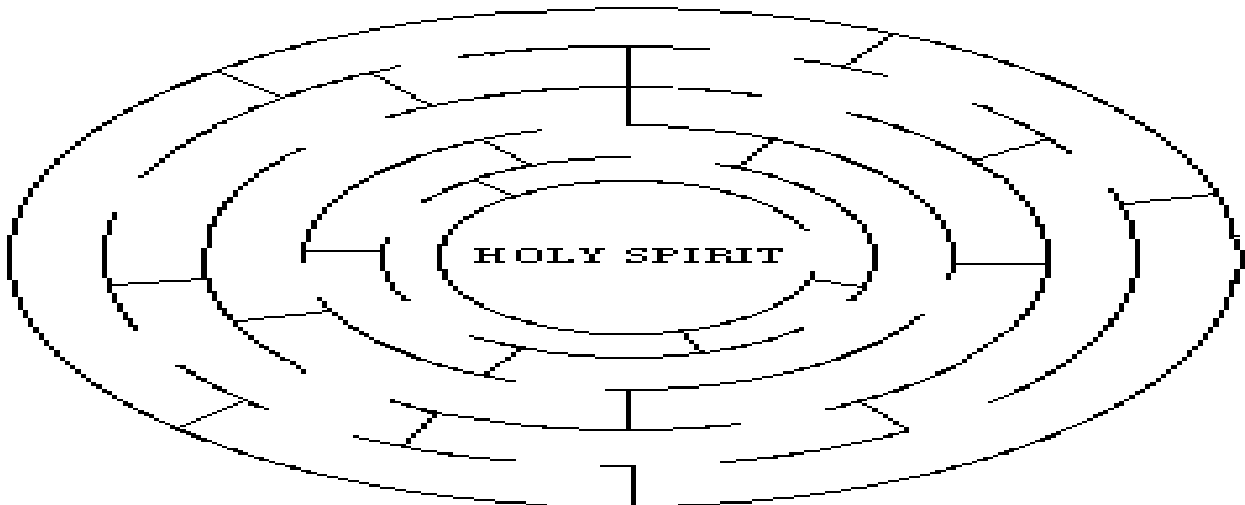

201. THE PROMISE OF THE HOLY SPIRIT

(JOHN 7:37-39)

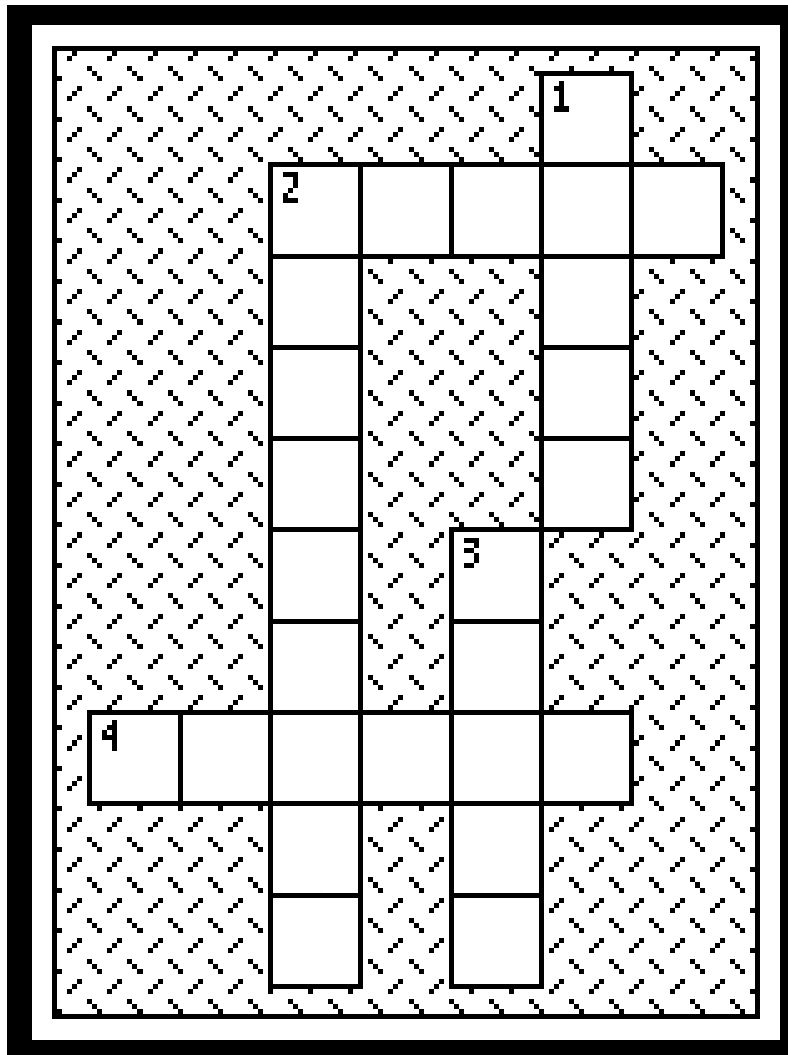

- 3 DOWN "On the last day, that great day of the feast, Jesus stood and cried out, saying, 'If anyone thirsts, let him come to Me and ____.'" **JOHN 7:37**
- 1 DOWN "He who believes in Me, as the Scripture has said, out of his ____ will flow rivers of living water." **JOHN 7:38**
- 4 ACROSS "...But this He spoke concerning the ____, whom those believing in Him would receive..." **JOHN 7:39**
- 2 ACROSS "...for the Holy Spirit was not yet ____..." **JOHN 7:39**
- 2 DOWN "...because Jesus was not yet ____." **JOHN 7:39**

Bible Story 202

WHO IS THE GREATEST

Matthew 18:1-5



"Jesus said, 'Whoever humbles himself as this little child is the greatest in the kingdom of heaven.' " *Matthew 18:4*

202. WHO IS THE GREATEST?

(MATTHEW 18:1-5)

MEMORY VERSE:

"Assuredly, I say unto you, unless you are converted and become as little children, you will by no means enter the kingdom of heaven." MATTHEW 18:3

CIRCLE THE CORRECT WORDS:

1. "At that time the disciples came to Jesus, saying, 'Who then is (**GREATEST, LEAST**) in the kingdom of heaven?' " **MATTHEW 18:1**
2. "And Jesus called a little (**LAMB, CHILD**) to Him, and set him in the midst of them." **MATTHEW 18:2**

TRUE OR FALSE:

3. "...and said, 'Assuredly, I say to you, unless you are converted and become as little children, you will by no means enter the kingdom of heaven.'" **MATTHEW 18:3**
TRUE OR FALSE

CIRCLE THE CORRECT WORD:

4. "Therefore whoever (**GRUMBLES, HUMBLES**) himself as this little child is the greatest in the kingdom of heaven." **MATTHEW 18:4**

UNDERLINE THE CORRECT ANSWER:

5. "And whoever receives one little child like this in My name receives..." **MATTHEW 18:5**
 - a. a reward
 - b. Me
 - c. nothing

202. WHO IS THE GREATEST?

(MATTHEW 18:1-5)

I	B	D	E	T	R	E	V	N	O	C	Z	Z	G	B
Z	C	B	T	H	S	N	S	I	Z	R	P	Y	K	B
A	B	P	C	Z	M	E	Q	E	I	K	A	R	F	V
A	Z	P	V	E	N	L	T	S	V	U	U	B	Q	K
W	M	N	S	S	I	Y	T	A	N	I	Y	I	N	G
C	I	E	H	Q	M	D	H	L	E	P	E	D	I	V
H	D	R	D	U	J	I	E	W	T	R	E	C	G	E
H	S	D	K	Z	C	S	A	J	S	S	G	A	E	A
O	T	L	I	F	W	C	V	F	Y	Q	D	M	J	R
F	A	I	N	N	G	I	E	K	T	V	K	D	L	B
B	K	H	G	M	G	P	N	H	U	M	B	L	E	Y
B	I	C	D	F	V	L	B	J	E	S	U	S	D	Z
Z	L	Y	O	I	B	E	B	G	G	Y	J	I	K	R
G	U	J	M	E	I	S	K	C	H	I	L	D	G	Q
F	H	V	L	V	F	E	S	A	R	E	Y	R	C	V

CHILD
CHILDREN
CONVERTED
DISCIPLES

GREATEST
HEAVEN
HUMBLE
JESUS

KINGDOM
MIDST
RECEIVES

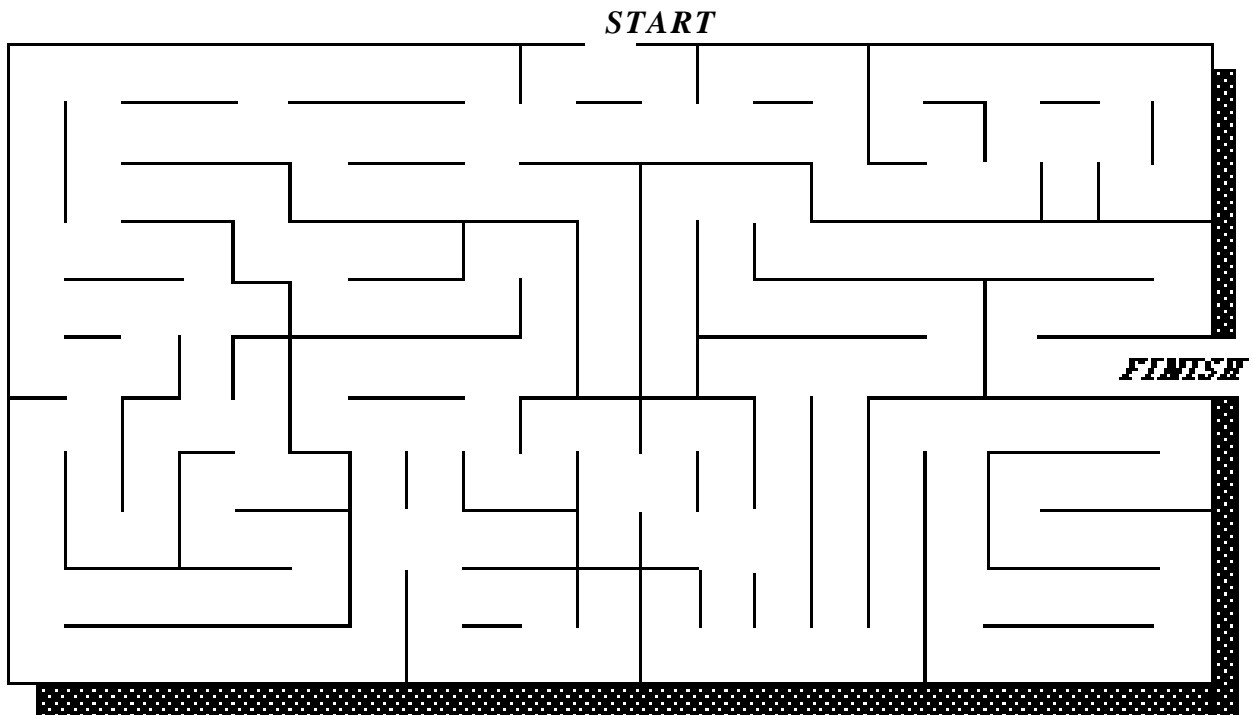

202. WHO IS THE GREATEST? (MATTHEW 18:1-5)

MEMORY VERSE:

"Assuredly, I say unto you, unless you are converted and become as little children, you will by no means enter the kingdom of heaven." MATTHEW 18:3

FILL IN THE BLANKS:

1. "At that time the disciples came to Jesus, saying, 'Who then is _____ in the kingdom of heaven?'" MATTHEW 18:1
2. "And Jesus called a little _____ to Him, and set him in the midst of them." MATTHEW 18:2

TRUE OR FALSE:

3. "...and said, 'Assuredly, I say to you, unless you are converted and , become as little children, you will by no means enter the kingdom of heaven.'" MATTHEW 18:3
TRUE OR FALSE

FILL IN THE BLANK:

4. "Therefore whoever _____ himself as this little child is the greatest in the kingdom of heaven." MATTHEW 18:4

UNDERLINE THE CORRECT ANSWER:

5. "And whoever receives one little child like this in My name receives..." MATTHEW 18:5
 - a. a reward
 - b. Me
 - c. nothing

202. WHO IS THE GREATEST?

(MATTHEW 18:1-5)

W V L N H Y B N F I P O C Z U E E U G D B P M D R Y L T B R
R G M B P F Z B H Y U W A O W H N G R D P F R W K D S V R H
E L O J U Z U Q O R R T B B Y R Y S E L T G I M S U D A J Q
B J B J M W O C C O P H N H F I I Q Y I G R C G J P M M F B
S C D G J G W J G I T Z B W Y V Y P K H C N B R D F V A H N
A T R J B Z E Y S T Y N I C O K Q H C C U C Q L D L C H P N
T U C V O T C C M E C O N V E R T E D E A D J R D S U L M B
E N B N J T U T E H W M B E S T S B E L Q S U Y W W M E S A
Q Y R H R J C G Z I Y B G R U R W N D T O O V M C U J U G Q
F T N H E A V E N B D O A Z B A T B O T A M R P N F W R J H
T F V E O G J D B O S M H B U E U Q B I B L F N S B W U N C
N U N A Z A T U I E T C Q P R L M T F L B W J S P B O W U G
B Y O T G H H B O S T A Q M G J O Y K L R R S I C O S G O I
T Z L E E Z U B B J C C Y B O K D O Q T J J A S K V Z N F I
I M O H C T H M V L W I C U B S G E U Q A W O J P B S H O J
T M B D J U L T B B N B P F N V N B S F H H I M T Z U E L P
L H Z I B J Z G D L G B L L T H I Q T S U S E J G O D H V B
K W Z L P Q R B H N E N V S E W K S R R B J P S S A C P C Z
W V V Q D K L R Q Z F S L U D S E P T D Z F M L P R Q Q P F
Q V B S J K E G B Z O I O Y H T K W F H H J P W B Y Q F F U
I N O Z P C T S D I M M B P A S T Q J K P Q S G K B H M T N
E C A G E V P A K Q B Q I E Y G P B S P Y L S F K V B G I Q
Q K O I D H J L Q B R F R B J T E O J P J L N M V R S G D D
G N V I Q S Z L I B N G B K T B B G E P U B Z L M L B D L C
A E H K A T C H I L D R E N G U O B F R G R Y C T N F C C U
S Z B W F O Z V J P S U L S P C G T H B P Y M B P Q O R L A
D Y W B A L U C G G A N A U M G K Y B J C M R P Z M Z D K E
B I B N H S P B P D G Q S I R B D U M L M Q Y F K V F E A I
D W K K D T F L C T U G M I Y A N K H Q K U F T R S O S D H
L Z Y C W R Q L Q M W T U Y L K M I T N J U Q V O C G S P T

CHILDREN
CONVERTED
DISCIPLES
ENTER

GREATEST
HEAVEN
HUMBLES
JESUS

KINGDOM
LITTLE CHILD
MIDST
RECEIVES

202. WHO IS THE GREATEST? (MATTHEW 18:1-5)

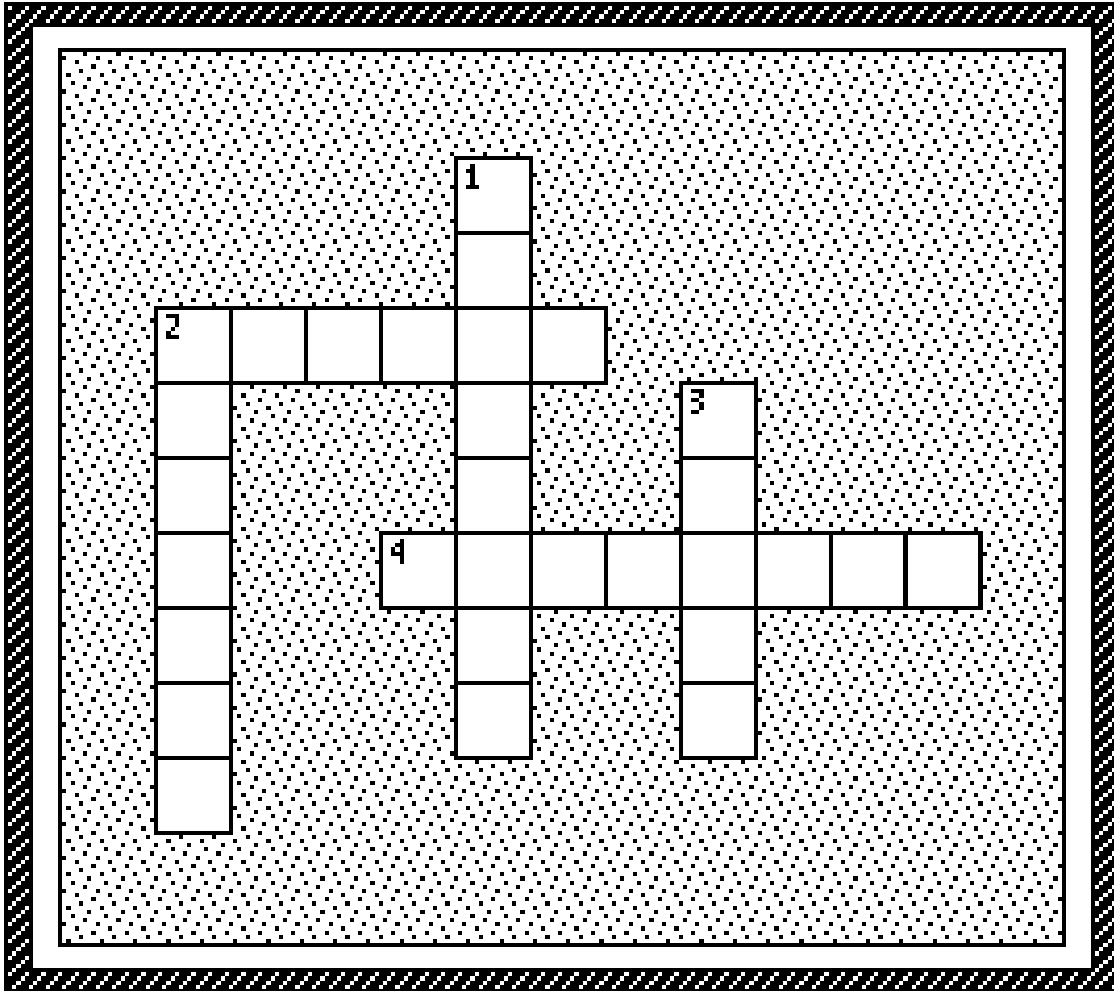

- 1 DOWN "At that time the disciples came to Jesus, saying, 'Who then is _____ in the kingdom of heaven?'" **MATTHEW 18:1**
- 3 DOWN "And Jesus called a little _____ to Him, and set him in the midst of them." **MATTHEW 18:2**
- 2 ACROSS "...and said, 'Assuredly, I say to you, unless you are converted and become as little children, you will by no means enter the kingdom of _____.'" **MATTHEW 18:3**
- 2 DOWN "Therefore whoever _____ himself as this little child is the greatest in the kingdom of heaven." **MATTHEW 18:4**
- 4 ACROSS "And whoever receives one little child like this in My name _____ Me." **MATTHEW 18:5**

Bible Story 203

**THE PARABLE
OF THE
LOST SHEEP**

Matthew 18:10-14



"The man rejoices when he finds the lost sheep." *Matthew 18:10 – 14*

203. THE PARABLE OF THE LOST SHEEP (MATTHEW 18:10-14)

MEMORY VERSE:

"For the Son of Man has come to save that which was lost." MATTHEW 18:11

TRUE OR FALSE:

1. "Take heed that you do not despise one of these little ones..." MATTHEW 18:10
TRUE OR FALSE

CIRCLE THE CORRECT WORD:

2. "...for I say to you that in heaven their angels always see the (THRONE, FACE) of My Father who is in heaven." MATTHEW 18:10

TRUE OR FALSE:

3. "For the Son of Man has come to save that which was lost." MATTHEW 18:11
TRUE OR FALSE

CIRCLE THE CORRECT WORD:

4. "...If a man has a hundred sheep, and one of them goes astray, does he not (LEAVE, SELL) the ninety-nine and go to the mountains to seek the one that is straying?" MATTHEW 18:12

TRUE OR FALSE:

5. "Even so it is not the will of your Father who is in heaven that one of these little ones should perish." MATTHEW 18:14
TRUE OR FALSE

203. THE PARABLE OF THE LOST SHEEP

(MATTHEW 18:10-14)

S P I L L Z U W U E B A A B Z
 O E A O B E V A S N N B H A B
 N R S S N Z R O W I E V A E L
 O I T T E Q N N O N N N Q S F
 F S R O V E P G W Y I B Q I A
 M H A R A B T F T T M I N M C
 A B Y I E B Y O H E Q D Y U E
 N K Y T H J W B Z N F R C Z P
 B Q R E U P O R N I U E L O M
 O I A H N G Y I M N N H V B B
 B J N I D D D N C S Q T B H U
 V G G B R T S S H E G A O W F
 D P E O E M T E B C S F B C S
 H C L E D P E A O A T B I E U
 Q Q S J N P T G M C C G B R Y

ANGELS
 ASTRAY
 FACE
 FATHER

FIND
 HEAVEN
 HUNDRED
 LEAVE

LOST
 NINETY NINE
 ONE
 PERISH

REJOICES
 SAVE
 SHEEP
 SON OF MAN

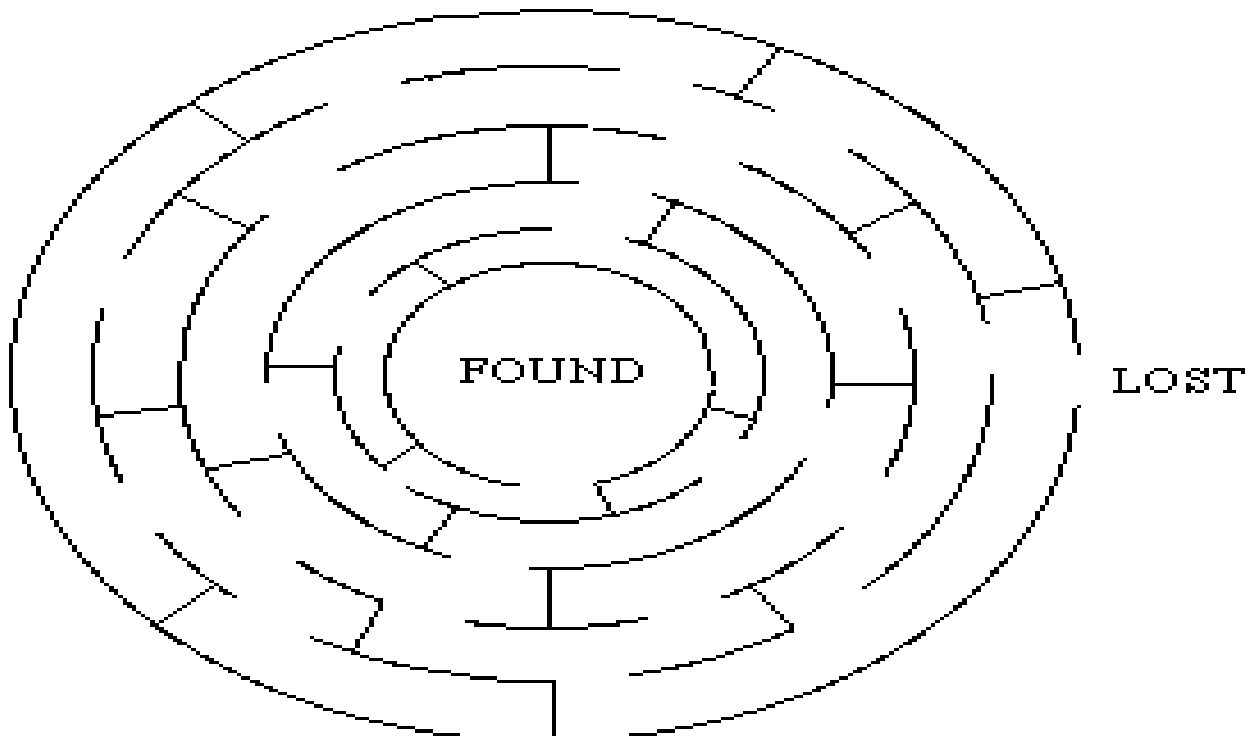

203. THE PARABLE OF THE LOST SHEEP (MATTHEW 18:10-14)

MEMORY VERSE:

"For the Son of Man has come to save that which was lost." MATTHEW 18:11

TRUE OR FALSE:

1. "Take heed that you do not despise one of these little ones..." MATTHEW 18:10
TRUE OR FALSE

FILL IN THE BLANK:

2. "...for I say to you that in heaven their angels always see the _____ of My Father who is in heaven." MATTHEW 18:10

TRUE OR FALSE:

3. "For the Son of Man has come to save that which was lost." MATTHEW 18:11
TRUE OR FALSE

FILL IN THE BLANK:

4. "...If a man has a hundred sheep, and one of them goes astray, does he not _____ the ninety-nine and go to the mountains to seek the one that is straying?" MATTHEW 18:12

TRUE OR FALSE:

5. "Even so it is not the will of your Father who is in heaven that one of these little ones should perish." MATTHEW 18:14
TRUE OR FALSE

203. THE PARABLE OF THE LOST SHEEP

(MATTHEW 18:10-14)

W Q V L E W L T Y C F B D B R E E W S C C B C B E T K B S I
 I T M N E Z B H W C S E W E V A S F R K T Q K S N A F I P Y
 Z C T O D O C H Y B E A I R V O I S S G T P S D W H S R G F
 Z Y F H C X E G M H Q N Y T B Z K R F S E J G L Q R C R O I
 T N W M C A O J R T V P M F I O A N C Z A Z C G K B M D T N
 F K Y Z L W W J F E H R H Q V J D C Q Z P J F H L C F Z Q Q D
 Y K F D G V P H Z J E M W P V D J R E L C D B C E C A F T Q
 D W E C G Z Y V I H K Y N Y O E T L S C G D T Y B J O P L F
 O I D V B Z V F T H P H E Z Y X B V V J G P S U R B S R P Q
 W J R E V M Z A D M S C L I K Y W F X D R S O U K Y B B W Q
 S Q L E N M F O U H W I I N G J C C J F B V L P Z R J Y V D
 R L B K S I Y P K O G G R Q O T L K P K S D D S E B G G P J
 Z H H B S M N U L P Q D Z E E W S B A V N S P W R E D N S O
 B U F Z F I S Y R D V J J V P H N D R Y W U I A R G Q G L H
 C G D B A X S U T E Y D Y A N A I C B S D B F K V I B B R R
 H I D O R O O R T E A O K X U U A E L H Z E M B B B K B E L
 J N V R E J I D A C N S X F Z I T Z E E S J S S J R A V R Y
 L T D B J H B Y L K H I T R P C N K Q E W M M P S V U A B J
 E M M B O U E M S W W F N R H W U B U P S U P V I I T L P J
 O L V T I B K A K C N W F I A Q O V N R R O T O S S I J V C
 O N P C C O G D V W O D Z J S Y M Q H H Z N N F K T E A J H
 W T T N E Y L L H E A U M N P A P W N W K K A O T N P O L S
 J H I P S D E U J O N I S W J R S B H M A U N L F Q G I B E
 A T H O V A N B B E R B W E Y R L B E Q H V E L P M D X X J
 G P N J V D O B R U B T N Y V W E R J A F O G H H I A J J G
 F N N E R A M Y Q U O O O N M Y G T P L N S I B I Y K N W E
 F C S E S U L E C E N A U U X M N A L E E W F W D J L R B J
 B B D T W Q T A O H E Z H Z B I A M S E A E H F D W Q I A P
 V F K Z A C T O C B T H G U M D I M K G D M Y K K J I Q S O
 W O Y D W N J I G K W Q F I M V I Q U I K Y I B T B W N V B

ANGELS
 ASTRAY
 DESPISE
 FACE
 FATHER
 FIND

HEAVEN
 HEED
 HUNDRED
 LEAVE
 LITTLE ONES

LOST
 MOUNTAINS
 NINETY NINE
 ONE
 PERISH

REJOICES
 SAVE
 SEEK
 SHEEP
 SON OF MAN

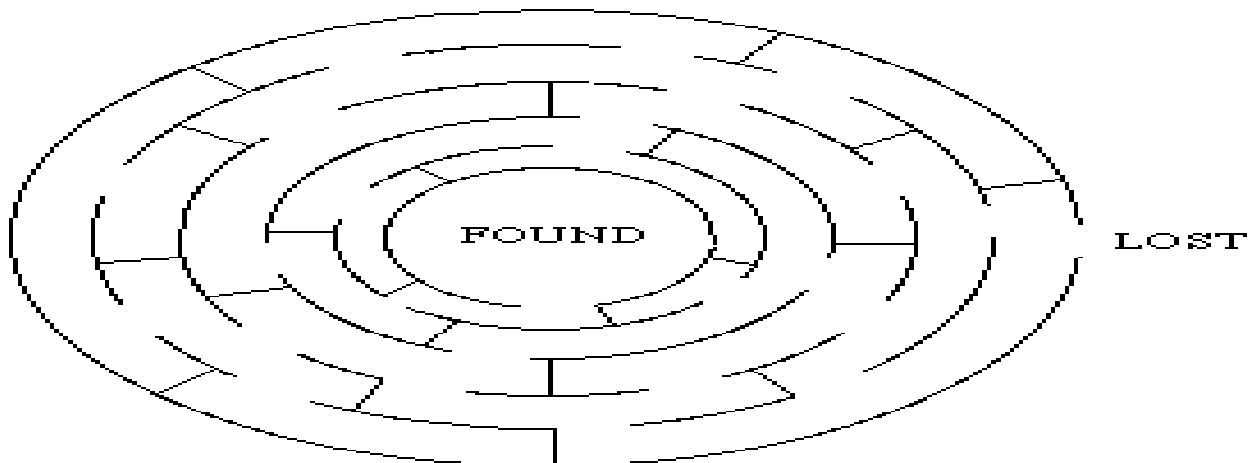

203. THE PARABLE OF THE LOST SHEEP

(MATTHEW 18:10-14)

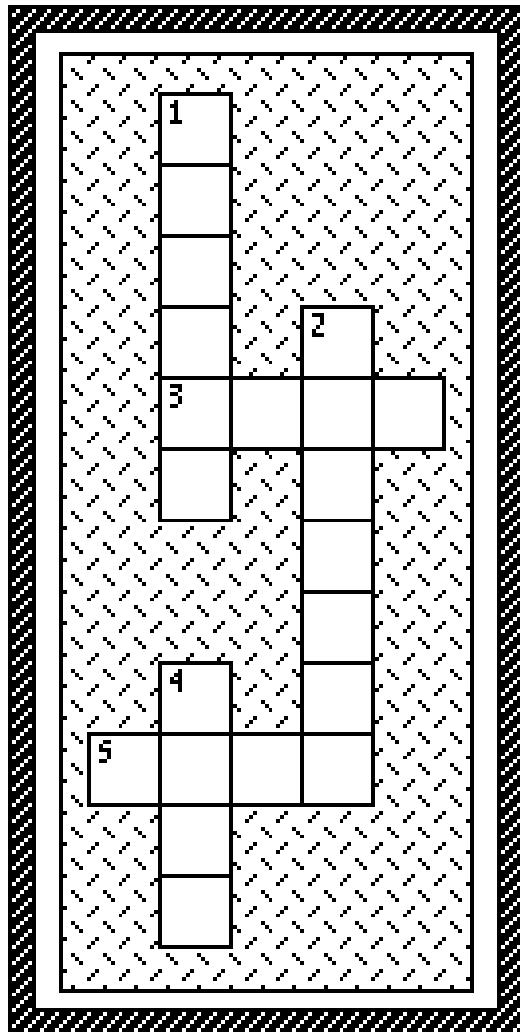

- 2 DOWN "Take heed that you do not _____ one of these little ones..." **MATTHEW 18:10**
- 4 DOWN "...for I say to you that in heaven their angels always see the _____ of My Father who is in heaven." **MATTHEW 18:10**
- 5 ACROSS "For the Son of Man has come to _____ that which was lost." **MATTHEW 18:11**
- 3 ACROSS "...If a man has a hundred sheep, and one of them goes astray, does he not leave the ninety-nine and go to the mountains to _____ the one that is straying?" **MATTHEW 18:12**
- 1 DOWN "Even so it is not the will of your Father who is in heaven that one of these little ones should _____." **MATTHEW 18:14**

Bible Story 204

**THE
ADULTEROUS
WOMAN**

JOHN 8: 1-12

204. THE ADULTEROUS WOMAN

(JOHN 8:1-12)

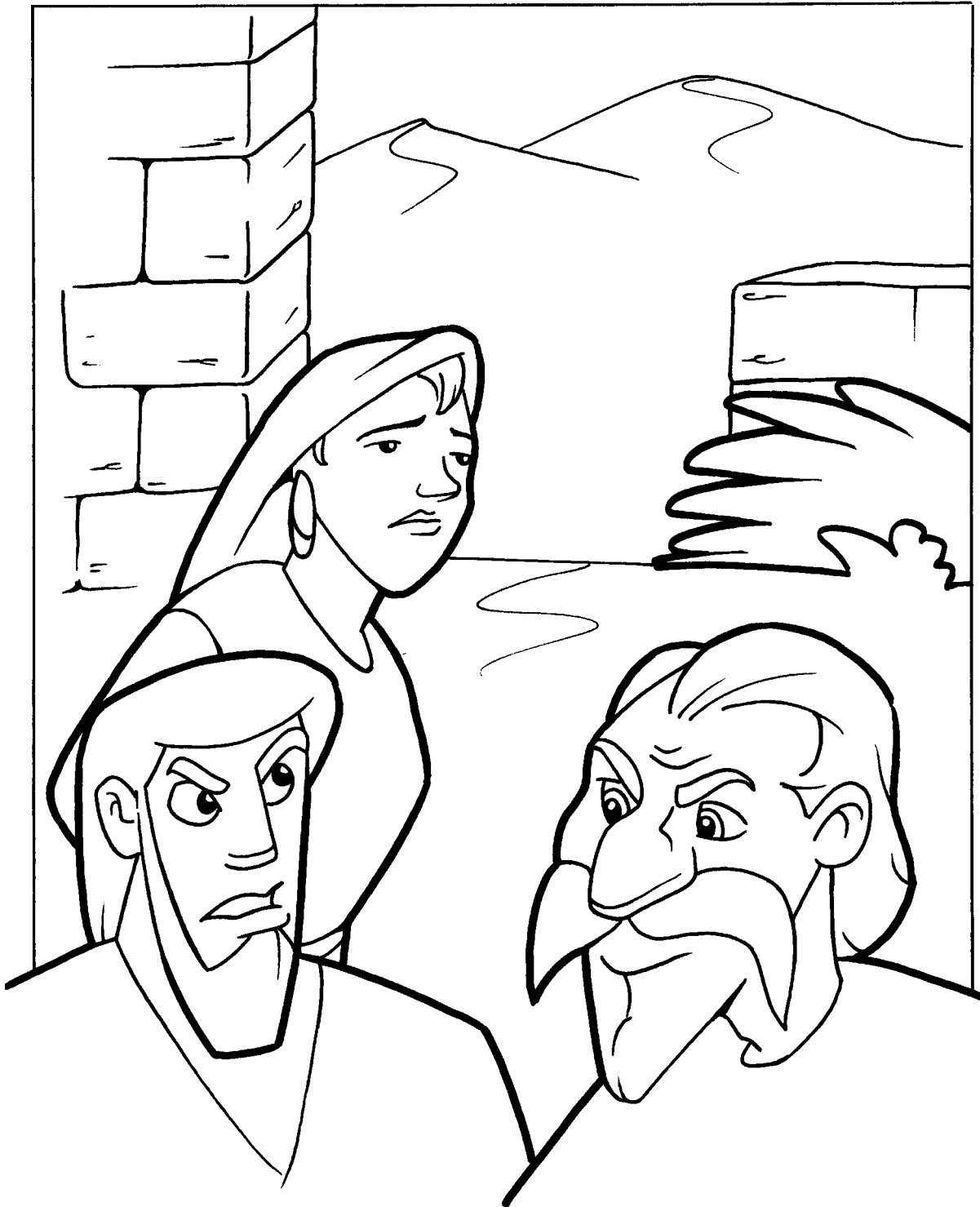

"So when they continued asking him, he lifted up himself, and said unto them, He that is without sin among you, let him first cast a stone at her. " **JOHN 8:78**

"And they which heard *it*, being convicted by *their own* conscience, went out one by one, beginning at the eldest, *even* unto the last: and Jesus was left alone, and the woman standing in the midst."

JOHN 8:9

204. THE ADULTEROUS WOMAN

(JOHN 8:1-12)

MEMORY VERSE:

"Then Jesus spoke to them again, saying, 'I am the light of the world. He who follows Me shall not walk in darkness, but have the light of life.' " JOHN 8:12

CIRCLE THE CORRECT WORDS:

1. "But early in the morning He came again into the (**HOUSE, TEMPLE**), and all the people came to Him; and He sat down and taught them." JOHN 8:2
2. "Then the scribes and Pharisees brought to Him a (**MAN, WOMAN**) caught in adultery..." JOHN 8:3

TRUE OR FALSE:

3. "Now Moses, in the law, commanded us that such should be stoned. But what do you say?"
JOHN 8:5

TRUE OR FALSE

4. This they said, testing Him, that they might then follow Him. JOHN 8:6
TRUE OR FALSE

CIRCLE THE CORRECT WORDS:

5. "...but Jesus stooped down and wrote on the ground with His finger, as though He did not (**HEAR, UNDERSTAND**)." JOHN 8:6
6. "So when they continued asking Him, He raised Himself up and said to them, 'He who is (**WITH, WITHOUT**) sin among you, let him throw a stone at her first.'" JOHN 8:7

TRUE OR FALSE:

7. "Then those who heard it, being convicted by their conscience, went out one by one, beginning with the oldest even to the last..." JOHN 8:9

TRUE OR FALSE

FILL IN THE BLANK:

8. "When Jesus had raised Himself up and saw no one but the woman, He said to her, 'Woman, where are those accusers of yours? Has no one condemned you?' She said, 'No one, Lord.' And Jesus said to her, 'Neither do I condemn you; go and _____ no more.'" JOHN 8:10-11

204. THE ADULTEROUS WOMAN

(JOHN 8:1-12)

S R C T L D Z H C P Y L Y J E
C R R O E G W T S A L I L E E
R B E K N M N Z B C T F A S N
I D W S B D P S T O N E C U Q
B M N U U H E L Y N Y A N S S
E O O O U C B M E V Q N Z R F
S G G R M U C M N I Q E Q A F
J W G L N O B A Q C W V C B K
B R L O Z I R T R T N O P W E
P O N R U R N E F E V T M M H
L T K D E F K G V D Q E W A L
B E Y G P H A R I S E E S U N
P U N Q R F N F K T H G I L I
Z I B I G S O N G W D N W T G
F B B I S R C T S E D L O Y M

ACCUSERS

LAST

MORNING

SIN

CONDEMN

LAW

NO MORE

STONE

CONVICTED

LIFE

OLDEST

TEMPLE

FINGER

LIGHT

PHARISEES

WOMAN

JESUS

LORD

SCRIBES

WROTE

204. THE ADULTEROUS WOMAN

(JOHN 8:1-12)

MEMORY VERSE:

"Then Jesus spoke to them again, saying, 'I am the light of the world. He who follows Me shall not walk in darkness, but have the light of life.' " JOHN 8:12

FILL IN THE BLANKS:

1. "But early in the morning He came again into the _____, and all the people came to Him; and He sat down and taught them." JOHN 8:2
2. "Then the scribes and Pharisees brought to Him a _____ caught in adultery..." JOHN 8:3

TRUE OR FALSE:

3. "Now Moses, in the law, commanded us that such should be stoned. But what do you say?"
JOHN 8:5

TRUE OR FALSE

4. This they said, testing Him, that they might then follow Him. JOHN 8:6
TRUE OR FALSE

FILL IN THE BLANKS:

5. "...but Jesus stooped down and wrote on the ground with His finger, as though He did not _____." JOHN 8:6
6. "So when they continued asking Him, He raised Himself up and said to them, 'He who is without _____ among you, let him throw a stone at her first.'" JOHN 8:7

TRUE OR FALSE:

7. "Then those who heard it, being convicted by their conscience, went out one by one, beginning with the oldest even to the last..." JOHN 8:9

TRUE OR FALSE

FILL IN THE BLANK:

8. "When Jesus had raised Himself up and saw no one but the woman, He said to her, 'Woman, where are those accusers of yours? Has no one condemned you?' She said, 'No one, Lord.' And Jesus said to her, 'Neither do I condemn you; go and _____ no more.'" JOHN 8:10-11

204. THE ADULTEROUS WOMAN

(JOHN 8:1-12)

I E T Y Z B L M J O H L Y P C P T Z U M C I J F L P K O S Y
O P T H G U A T F A P K T A V P O S D G D O D Y F I N G E R
V Z I Y B G L L A W E H D B Z U N N Y G Y W N I S U R Q A S
Q C O O P Y M B H V R D J V K Z I S G R R A V R V V W H L G
Z C T F J P S B A O V D I Q F V J T T S Q E C N P L Y U Y U
U Q A V H Y Z A W M A O P D K F J O I H S P U L T R B N J I
A I W O M A N C H F R K T V S R Y N I U T E A T E S T I N G
N W N B G B F W Z S L Q V S M K T E P V B Q N M J R G H H S
M T R S S R E S U C C A R M O K H D G Y K T U K I E P P W C
G Z E V E D P J Y W W K F C A Y G C C Y I F T A R V F U Z T
F K P A O R G U N U J L E Z T R F Z J R J V E X P A Q Y A E
H K I M C L K K J D U W J L M G Y B N T E I K T K U D N P K
A Q Q A U H D O T F O K O U Z I Q R H G N I N R O M K M B E
T J D Z W C E E P S I I U T J C D P E E F F O O D V G H I O
E B J S D G B R S J E R G M S K O J D U S R O N A P X B C E
M B Q H W R U I L T P J S O M U C N B S A N P K Y I Q Y N N
P R S E E S I R A H P S F T B A M P D S G Y F V S R L A Z S
L B R M W G K T J H T U K E P V P Q Y E Q M D E G F J O F M
E K I B Y I C E K L A W D M C B O B K F M Z H F L V V M N J
L E L S P N T J C Q C E B B D O E Q K J F N D G J A U B F D
I F S V Z G U H V O S A K N T U A F J S H U E S M E S H P H
F J T O W Z M K O E D V K O B W Y G M G W I F D B Q S T G R
E T F J B J D K T U C N A B O V U A V R U K W L T B B U G T
W E N J M P L P W W T D U R B Z H M S E B I R C S I E N S K
B C O N V I C T E D H Q L O G A A M W A I N Y C L P A X Z R
P J M E W N S Z H E U D T U R U E A Z S K M S T H G I L A X
E Z O A U U V Y P B E E W L E G C O F F E C K Y A O F V B W
S Z R W F O R Y J K C N L P I E N K I N Y D T D B R I I K U
G K E E T O R W H S N R A M K F A C Z T B N L A W A M U O E
D C A L I F C O Q U Q Y P C B P I Y T Q T Y E T H V I S M E

ACCUSERS
CONDEMNED
CONVICTED
DARKNESS
FINGER
FIRST
GROUND
JESUS

LAST
LAW
LIFE
LIGHT
MORNING
NO MORE
OLDEST

PHARISEES
SCRIBES
SIN
STONED
TAUGHT
TEACHER
TEMPLE

TESTING
THROW
WALK
WITHOUT
WOMAN
WORLD
WROTE

204. THE ADULTEROUS WOMAN (JOHN 8:1-12)

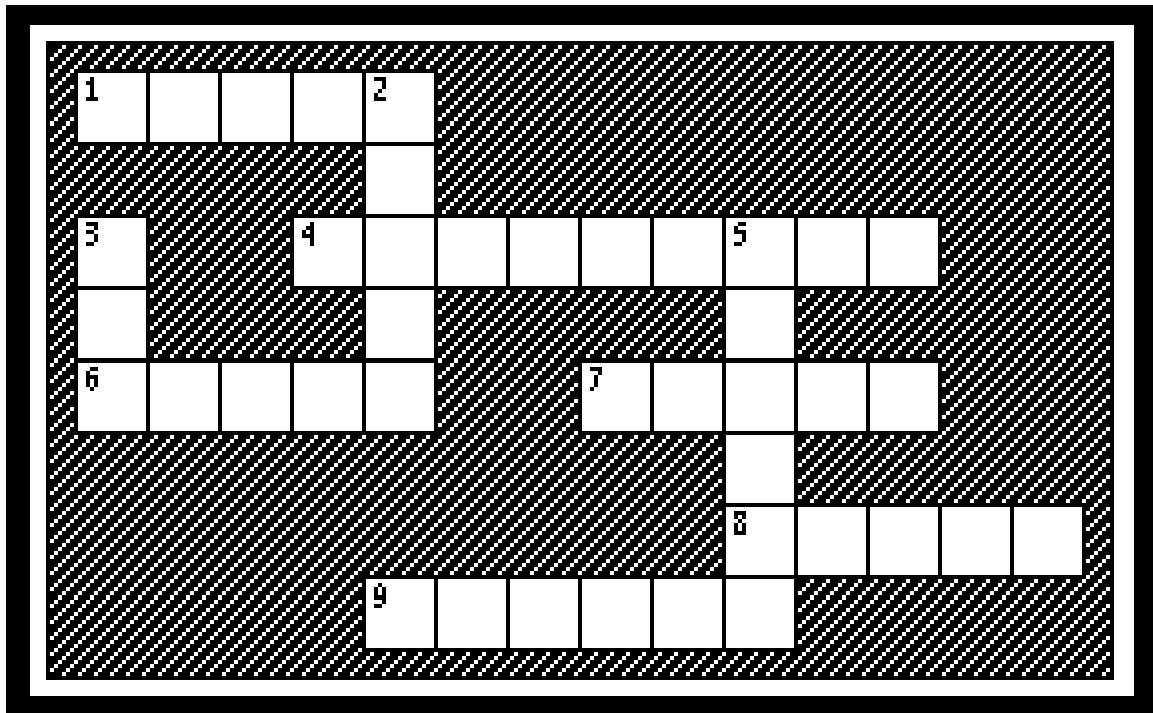

- 5 DOWN "But early in the morning He came again into the _____, and all the people came to Him; and He sat down and taught them." **JOHN 8:2**
- 7 ACROSS "Then the scribes and Pharisees brought to Him a _____ caught in adultery..." **JOHN 8:3**
- 3 DOWN "Now Moses, in the _____, commanded us that such should be stoned. But what do you say?" **JOHN 8:5**
- 9 ACROSS "This they said, testing Him, that they might have something of which to _____ Him.". **JOHN 8:6**
- 6 ACROSS "...but Jesus stooped down and _____ on the ground with His finger, as though He did not hear." **JOHN 8:6**
- 2 DOWN "So when they continued asking Him, He raised Himself up and said to them, 'He who is without sin among you, let him throw a _____ at her first.'" **JOHN 8:7**
- 4 ACROSS "Then those who heard it, being _____ by their conscience, went out one by one, beginning with the oldest even to the last..." **JOHN 8:9**
- 1 ACROSS "When Jesus had raised Himself up and saw no one but the woman, He said to her, 'Woman, where are those accusers of yours? Has no one condemned you?' She said, 'No one, Lord.' And _____ said to her, 'Neither do I condemn you; go and sin no more.'" **JOHN 8:10-11**
- 8 ACROSS "Then Jesus spoke to them again, saying, 'I am the _____ of the world. He who follows Me shall not walk in darkness, but have the light of life.'" **JOHN 8:12**

Bible Story 205

**JESUS HEALS
THE
BLIND MAN**

JOHN 9:1-41



"Jesus anoints the blind man's eyes with clay."
John 9:6

205. JESUS HEALS THE BLIND MAN

(JOHN 9:1-41)

MEMORY VERSE:

"And Jesus said, 'For judgment I have come into this world, that those who do not see may see, and that those who see may be made blind.' " JOHN 9:39

TRUE OR FALSE:

1. Now as Jesus passed by, He saw a man who was deaf from birth. **JOHN 9:1**
TRUE OR FALSE
2. "And His disciples asked Him, saying, 'Rabbi, who sinned, this man or his parents, that he was born blind?' " **JOHN 9:2**
TRUE OR FALSE

CIRCLE THE CORRECT WORD:

3. "Jesus answered, 'Neither this man nor his parents sinned, but that the works of God should be **(HIDDEN, REVEALED)** in him.' " **JOHN 9:3**

TRUE OR FALSE:

4. "When He had said these things, He spat on the ground and made clay with the saliva; and He anointed the eyes of the blind man with the clay." **JOHN 9:6**
TRUE OR FALSE
5. And He said to him, "Go, wash in the pool of Siloam." But, when he went and washed, he was still blind. **JOHN 9:7**
TRUE OR FALSE
6. "But the Jews did not believe concerning him, that he had been blind and received his sight, until they called the parents of him who had received his sight." **JOHN 9:18**
TRUE OR FALSE

CIRCLE THE CORRECT WORDS:

7. "Jesus heard that they had cast him out; and when He had found him, He said to him, 'Do you **(BELIEVE IN, SEE)** the Son of God?' " **JOHN 9:35**
8. "He answered and said, 'Who is He, Lord, that I may believe in Him?' And Jesus said to him, 'You have both **(SEEN, MOCKED)** Him and it is He who is **(TALKING, WALKING)** with you.' "
JOHN 9:36-37

TRUE OR FALSE:

9. "Then he said, 'Lord, I believe!' And he worshiped Him." **JOHN 9:38**
TRUE OR FALSE

205. JESUS HEALS THE BLIND MAN

(JOHN 9:1-41)

S G D L R O W R H L F F L S H
M K L V E M Z O Z O U R E S H
R Z Q I G A T M Y C W H R V O
M D K N W U U Q Q E T D Z Y F
C I O E K A S D D G N K P Z B
T L E A R L L T P L Y S D N I
Q Y K A G M I O V V R F H O B
F N H Q I I G U M T D O M W Z
D A Y N U F H C V Y H B W K G
N P B B J L T H O E I Y Y I F
M A J P A T V E T R I D T Z B
G N O F H G M Q J B A I H A C
V A H E H B Y J Z W L C E A B
S W N M P Y A B O I M A U W Z
A Q J G R V J B V B N P K C A

FIND THE WORDS OF THE VERSE BELOW IN THE PUZZLE ABOVE

"As long as I am in the world, I am the light of the world."

JOHN 9:5

START

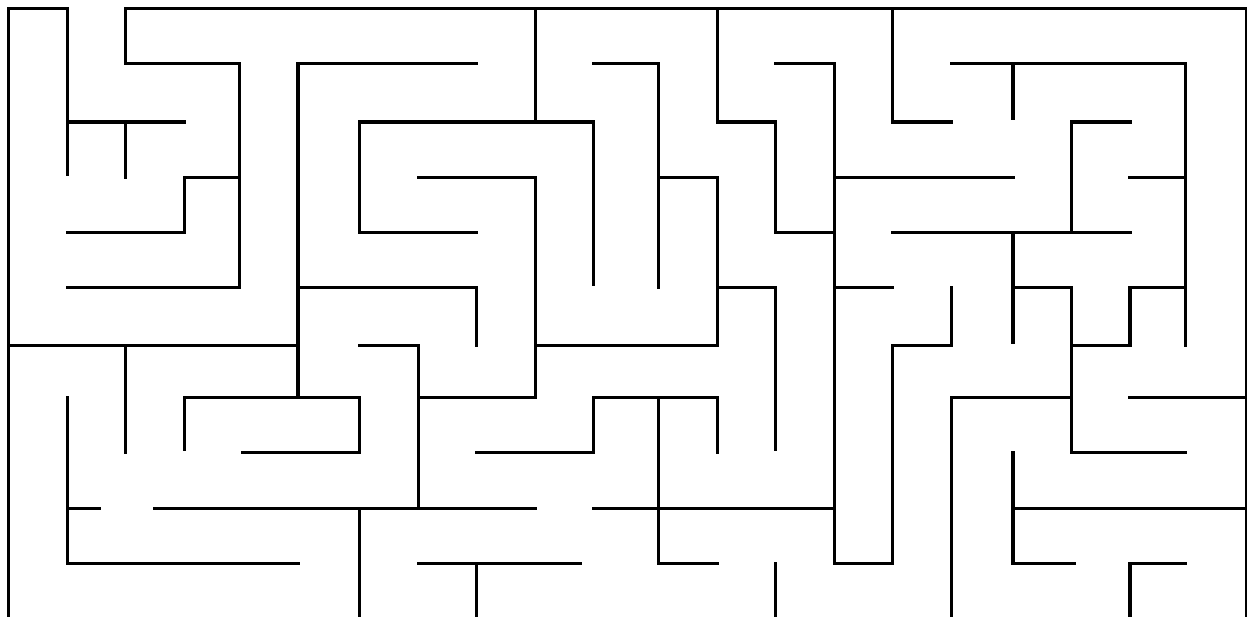

FINISH

205. JESUS HEALS THE BLIND MAN

(JOHN 9:1-41)

MEMORY VERSE:

"And Jesus said, 'For judgment I have come into this world, that those who do not see may see, and that those who see may be made blind.' " JOHN 9:39

TRUE OR FALSE:

1. Now as Jesus passed by, He saw a man who was deaf from birth. **JOHN 9:1**
TRUE OR FALSE
2. "And His disciples asked Him, saying, 'Rabbi, who sinned, this man or his parents, that he was born blind?' " **JOHN 9:2**
TRUE OR FALSE

FILL IN THE BLANK:

3. "Jesus answered, 'Neither this man nor his parents sinned, but that the works of God should be _____ in him.' " **JOHN 9:3**

TRUE OR FALSE:

4. "When He had said these things, He spat on the ground and made clay with the saliva; and He anointed the eyes of the blind man with the clay." **JOHN 9:6**
TRUE OR FALSE
5. And He said to him, "Go, wash in the pool of Siloam." But, when he went and washed, he was still blind. **JOHN 9:7**
TRUE OR FALSE
6. "But the Jews did not believe concerning him, that he had been blind and received his sight, until they called the parents of him who had received his sight." **JOHN 9:18**
TRUE OR FALSE

FILL IN THE BLANKS:

7. "Jesus heard that they had cast him out; and when He had found him, He said to him, 'Do you _____ the Son of God?' " **JOHN 9:35**
8. "He answered and said, 'Who is He, Lord, that I may believe in Him?' And Jesus said to him, 'You have both _____ Him and it is He who is _____ with you.' " **JOHN 9:36-37**

TRUE OR FALSE:

9. "Then he said, 'Lord, I believe!' And he worshiped Him." **JOHN 9:38**
TRUE OR FALSE

205. JESUS HEALS THE BLIND MAN

(JOHN 9:1-41)

J F Q V Z L D K P C Q P H I E B K B T M C N B R D P M M F B
 Z S I V V Q J V J B I U Z B R U S O Y T U C Q L D F V A H N
 A H E N B S P H Z B Y R N G Z G V G U H A D J R D L C H P N
 P Q Q C O Z D S Z B R P M A E O H K K G Q S U Y W S U L M B
 B G G K A G Q T U F O T B H B H W D I I O O V M C W M E S A
 A B A N O I A O P H I Y O Q P B T N G L A M R P N U J U G Q
 Z R D Z H K F L F O J O H N M N S M R H B L F N S F W R J H
 B N B Y B W A S Q C T W M Q B T G U E T B W J S P B W U N C
 U G D I W B H T N G E Y C Y U D T G Y D R R S I C B O W U G
 I W L W B N D R B S H D A C F H B S K L J J A S K O S G O I
 C R V Z K K W L Q M I S C L S Y U Q C T A W O S A V Z N F I
 T E G L Y C Y B O E B T B V U J C P D Q H H T J P B S H O J
 N B L M O H F Z C N O T B B Y T G H O F B H I M T Z U E L P
 J S J F N P Z U J Z G W N O P G B B B R E J P S G O D H V B
 A A C O B U W O Y B E N I B I P A B F D Z F M L S A C P C Z
 E T M B J M G W C O J G I I B M K Q K H H J P W P R Q Q P F
 K A T D J D Z E T B L F M B K R E T E K P Q S G B Y Q F F U
 R E U R L J T C G V B O Q B S Y N H Q P Y L S F K B H M T N
 O Q N R G B T I U D N B F A U L T Y U P J L N M K V B G I Q
 L F O C J O N U B H Z R U S I E Y O S P U B Z L V R S G D D
 D W Y B V J J C B Q Z N N M I H I E R R G R Y C M L B D L C
 E T T R N R G J T B Q S Q U Y R Y B T B P Y M B T N F C C U
 W N F N H O A T G K B A G Z U I Q Q F J C M R P P Q O R L A
 V B U V E Z Z H B Q B G D O W V S P J L M Q Y F Z M Z D K E
 J T Y N A G A M G I P L T B Y K W W S Q K U F T K V F E A I
 R I Z O T E T H A J R U C H F T U Q J N J U Q V R S O S D H
 G T M L E C U L L O G W A W Y R K B E B P M D R O C G S P T
 C L M O H J J Z W G D O B C O A T O F P F R W K Y L T B R J
 H K H B D B Q R L P T W N S S L P G H T G I M S D S V R H B
 M W W Z I P K L V C M T B A U J E B B G R C G J U D A J Q K

FIND THE WORDS OF THE VERSE BELOW IN THE PUZZLE ABOVE

"As long as I am in the world, I am the light of the world."

JOHN 9:5

START

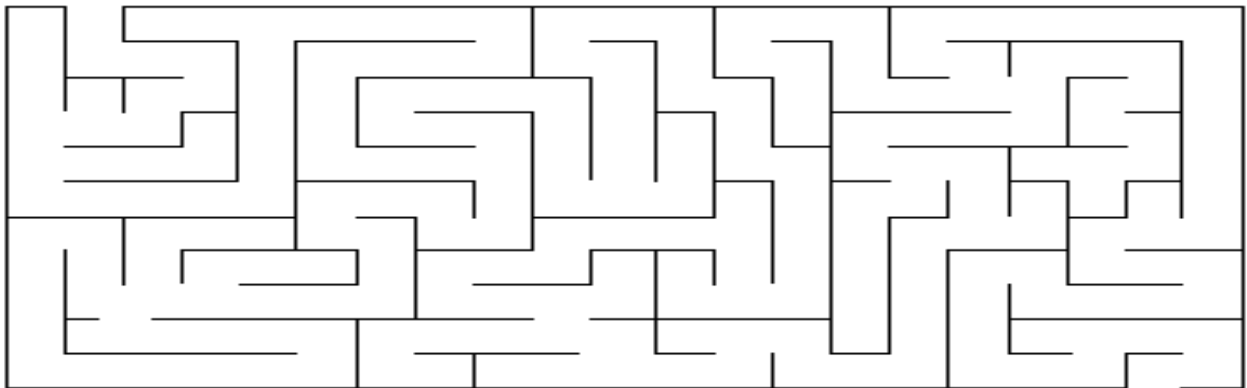

FINISH

205. JESUS HEALS THE BLIND MAN

(JOHN 9:1-41)

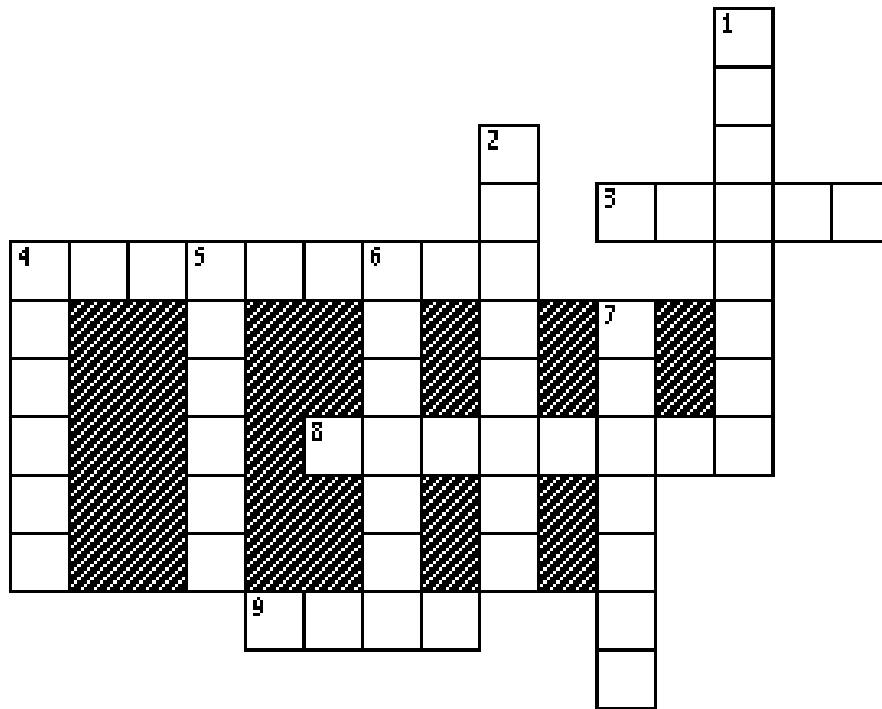

- 3 ACROSS "Now as Jesus passed by, He saw a man who was _____ from birth." **JOHN 9:1**
- 5 DOWN "And His disciples asked Him, saying, 'Rabbi, who _____, this man or his parents, that he was born blind?' " **JOHN 9:2**
- 8 ACROSS "Jesus answered, 'Neither this man nor his parents sinned, but that the works of God should be _____ in him.' " **JOHN 9:3**
- 1 DOWN "When He had said these things, He spat on the ground and made clay with the saliva; and He _____ the eyes of the blind man with the clay." **JOHN 9:6**
- 4 DOWN "And He said to him, 'Go, wash in the pool of Siloam.' So he went and _____, and came back seeing." **JOHN 9:7**
- 6 DOWN "But the Jews did not believe concerning him, that he had been blind and received his sight, until they called the _____ of him who had received his sight." **JOHN 9:18**
- 9 ACROSS "Jesus heard that they had _____ him out; and when He had found him, He said to him, 'Do you believe in the Son of God?' " **JOHN 9:35**
- 7 DOWN "He answered and said, 'Who is He, Lord, that I may _____ in Him?' And Jesus said to him, 'You have both seen Him and it is He who is talking with you.' " **JOHN 9:36-37**
- 4 ACROSS "Then he said, 'Lord, I believe!' And he _____ Him." **JOHN 9:38**
- 2 DOWN "And Jesus said, 'For _____ I have come into this world, that those who do not see may see, and that those who see may be made blind.' " **JOHN 9:39**

Bible Story 206

**THE
GOOD
SHEPHERD**

JOHN 10: 1-21



"Jesus said, 'I am the good shepherd. The good shepherd gives His life for the sheep.'" *John 10:11*

206. THE GOOD SHEPHERD

(JOHN 10:1-21)

MEMORY VERSE:

"I am the good shepherd; and I know My sheep, and am known by My own." JOHN 10:14

CIRCLE THE CORRECT WORD:

1. "Most assuredly, I say to you, he who does not enter the sheepfold by the (**DOOR, WINDOW**), but climbs up some other way, the same is a thief and a robber." JOHN 10:1

TRUE OR FALSE:

2. "But he who enters by the door is the shepherd of the sheep." JOHN 10:2
TRUE OR FALSE
3. "To him the doorkeeper opens, and the sheep hear his voice; and he calls his own sheep by name and leads them out." JOHN 10:3
TRUE OR FALSE

CIRCLE THE CORRECT WORDS:

4. "And when he brings out his own sheep, he goes before them; and the sheep follow him, for they know his (**NAME, VOICE**)." JOHN 10:4
5. "Then Jesus said to them again, 'Most assuredly, I say to you, I am the door of the (**HOUSE, SHEEP**).'" JOHN 10:7

TRUE OR FALSE:

6. "I am the door. If anyone enters by Me, he will be saved, and will go in and out and find pasture." JOHN 10:9
TRUE OR FALSE

CIRCLE THE CORRECT WORDS:

7. "I am the good shepherd. The good shepherd gives His (**LIFE, TIME**) for the sheep." JOHN 10:11
8. "I am the good shepherd; and I (**KNOW, SEE**) My sheep, and am (**KNOWN, SEEN**) by My own." JOHN 10:14
9. "As the Father knows Me, even so I know the Father; and I lay down My life for the (**HIRELING, SHEEP**)." JOHN 10:15

206. THE GOOD SHEPHERD

(JOHN 10:1-21)

Y O T U N W Y A S R Z S Z Z D
D O C G C Y D S V B D S O M T
O W Y I B F V K E B E F B M O
W J N N F E D Y K T E F M A A
S Y K T R D M L B C D O A M U
R A L M O O V N Z N C A I I Q
Z G K D J R O O N P C V T B C
B F W L E L P D I T H E S O N
C F I S S R T H A H L S O J L
H B A N U B U M G E T W M S B
J I J T S H I S A O G H H U C
D V H T V F U Z S J G E E B I
L E Q H M T H O B A E A W M E
N W L T T O N D Y P B W V O O
E Q H P F D N C O T V W Z Y W



FIND THE WORDS OF THE VERSE BELOW IN THE PUZZLE ABOVE

"Then Jesus said to them again, 'Most assuredly, I say to you, I am the door of the sheep.' " JOHN 10:7

START

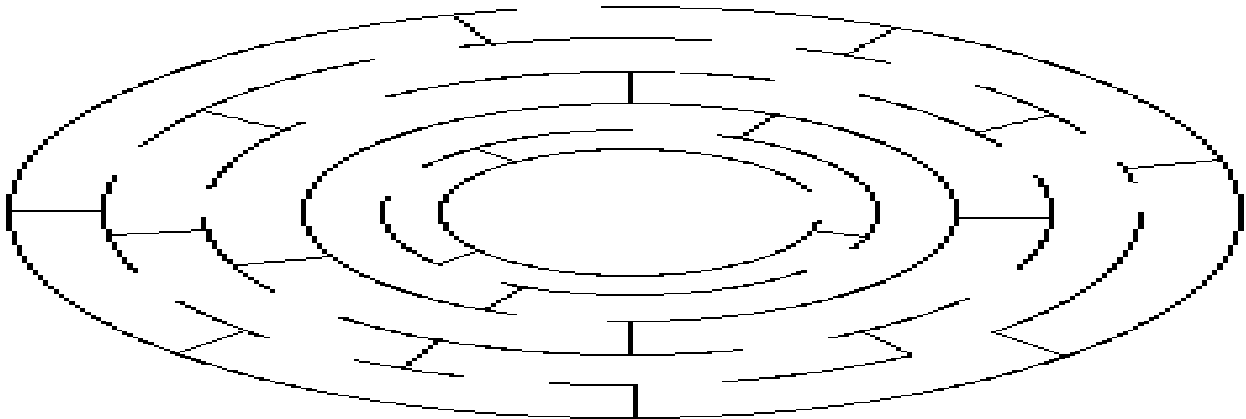

206. THE GOOD SHEPHERD (JOHN 10:1-21)

MEMORY VERSE:

"I am the good shepherd; and I know My sheep, and am known by My own." JOHN 10:14

FILL IN THE BLANK:

1. "Most assuredly, I say to you, he who does not enter the sheepfold by the _____, but climbs up some other way, the same is a thief and a robber." JOHN 10:1

TRUE OR FALSE:

2. "But he who enters by the door is the shepherd of the sheep." JOHN 10:2
TRUE OR FALSE
3. "To him the doorkeeper opens, and the sheep hear his voice; and he calls his own sheep by name and leads them out." JOHN 10:3
TRUE OR FALSE

FILL IN THE BLANKS:

4. "And when he brings out his own sheep, he goes before them; and the sheep follow him, for they know his _____." JOHN 10:4
5. "Then Jesus said to them again, 'Most assuredly, I say to you, I am the door of the _____.'" JOHN 10:7

TRUE OR FALSE:

6. "I am the door. If anyone enters by Me, he will be saved, and will go in and out and find pasture." JOHN 10:9
TRUE OR FALSE

FILL IN THE BLANKS:

7. "I am the good shepherd. The good shepherd gives His _____ for the sheep." JOHN 10:11
8. "I am the good shepherd; and I _____ My sheep, and am _____ by My own." JOHN 10:14
9. "As the Father knows Me, even so I know the Father; and I lay down My life for the _____." JOHN 10:15

206. THE GOOD SHEPHERD (JOHN 10:1-21)

K F T M H S O U Y B C A B D U Q J O U N Y M X H C Z D K X Z
 L W E K S J H K G B J N D W Z B D G F N L D F W E Y F O R H
 C H C I T P G P B S U L N Y N B N U L R A Z Z Q N H T M Z R
 T V H Z N C B B E E D B D H U V N U S Y N N S I T O G H A V
 Z F Q A V E R Z I L W Y Q S Q B U R A Q Z S Q B E W V L E Q
 Y H I K H B O K K T S E W M V J A W S R Q I G F V V Y B M P
 G U W W N R M S E U R B J K I P G G S F C V H U E N N T N R
 N B T B Y N H Q I D R R T Y Z U M G U V P W L L L K J C C Y
 O T L I C Q R V S J V A U O S V F L R M W P B N Y W K A I P
 H B J D M S N Z I I Y G X H L B V N E G R C Q Y E B K P P U
 S G D B R P N R R I B T P I C M S K D P A P Z V C U A P M I
 O H U R C Z Z D E U D I D Q K V J Y L W B Y S J V D D M H Q
 T E J H B B Y R B G D O T K W S I B Y Y W Z M A Q Y H D M R
 P C U Z C K Z C N Z I Y V L Q E B B R T M O I G J Q O W E K
 W R H B F E K N P E N M P Z B B V K Z Y U C C I W O A M G C
 N M T V E V B Y V G B B T M G J D U W Q T U U I R S S D N V
 M S N B B K G I W M F W D M U O Y Q N Q S W J F U D Q A H M
 W Z T J Q E Z R W S N S P N E P V I B H Y O Y A B G T E E O
 O W V R Q W L P N O J N U K N W T L E N E R K S J O U N F S
 Z I F K R X K H D K M S T T D W J E B V E H N F N N D P C T
 E B Y Y V K J B B T P I Q F H C P B K Q N Q B Y E H M J S I
 B J A P Q K P Y A A Y M L A I E B U N D Q P O V T Q O Y N J
 P S E L M W N D W G K M Y S L B P Z O A S O J O T H S Q Z S
 G V I S L Y N K A A W Z A E W N L U B N F B I L N H B Q H U
 U S Q M U E F S M I Y I I F S Y B R H E F I B M T A Q Y M D
 B B Y D I S J N S N D K G Q H K P G Z V K K E O Q J Y C D S
 A B K R N R N E E A E J Q B Y I Z D M T E U G M O B T G E Z
 U W S F I J K H L H A Y I B K M R G T E H H B V S O N O W Y
 W H U P C J E N G S T M G L E I B E H T I S V Z U B V F E H
 Z R F Z V G W J J E U S J P R T D H F N G E W Y M F H B Z K

FIND THE WORDS OF THE VERSE BELOW IN THE PUZZLE ABOVE

"Then Jesus said to them again, 'Most assuredly, I say to you, I am the door of the sheep.' " JOHN 10:7



206. THE GOOD SHEPHERD

(JOHN 10:1-21)

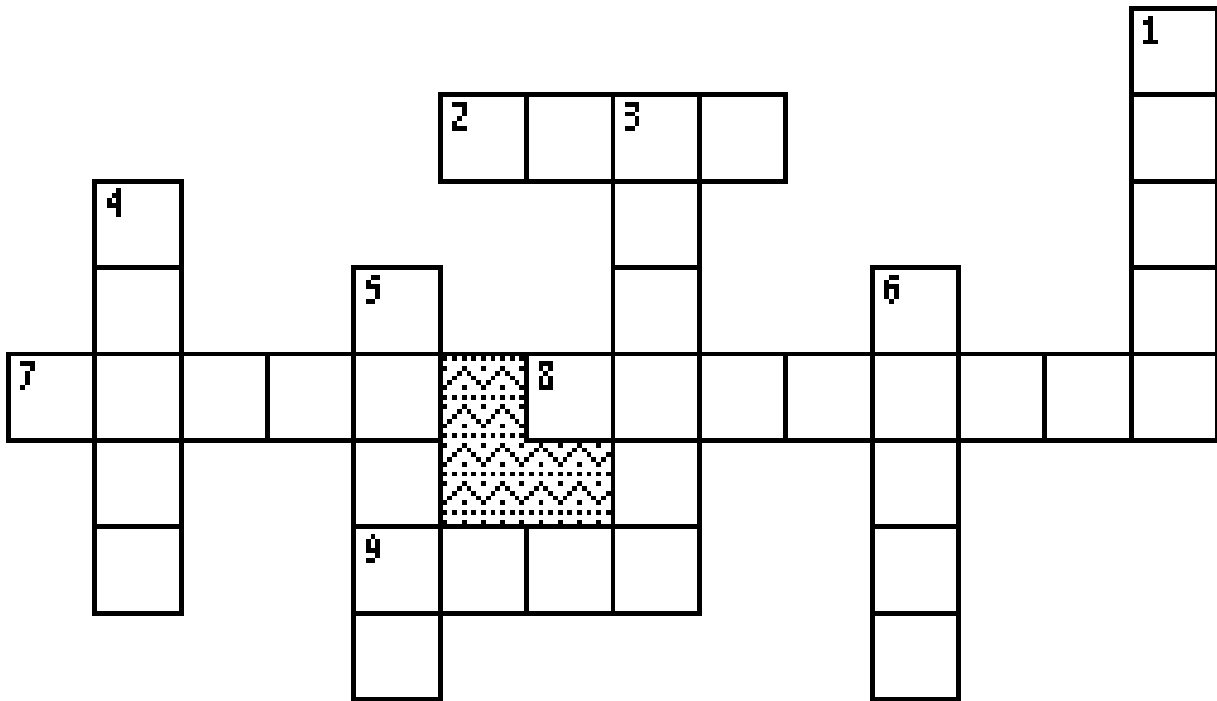

- 9 ACROSS "Most assuredly, I say to you, he who does not enter the sheepfold by the _____, but climbs up some other way, the same is a thief and a robber." **JOHN 10:1**
- 8 ACROSS "But he who enters by the door is the _____ of the sheep." **JOHN 10:2**
- 5 DOWN "To him the doorkeeper opens, and the sheep hear his voice; and he calls his own sheep by name and _____ them out." **JOHN 10:3**
- 7 ACROSS "And when he brings out his own sheep, he goes before them; and the sheep follow him, for they know his _____." **JOHN 10:4**
- 6 DOWN "Then Jesus said to them again, 'Most assuredly, I say to you, I am the door of the _____.'" **JOHN 10:7**
- 1 DOWN "I am the door. If anyone enters by Me, he will be _____, and will go in and out and find pasture." **JOHN 10:9**
- 2 ACROSS "I am the good shepherd. The good shepherd gives His _____ for the sheep." **JOHN 10:11**
- 4 DOWN "I am the good shepherd; and I know My sheep, and am _____ by My own." **JOHN 10:14**
- 3 DOWN "As the _____ knows Me, even so I know the Father; and I lay down My life for the sheep." **JOHN 10:15**

Bible Story 207

JESUS RAISES LAZARUS

JOHN 11:1-44



"Jesus raises Lazarus."
John 11:1 – 44

207. JESUS RAISES LAZARUS

(JOHN 11:1-44)

MEMORY VERSE:

"Jesus said to her, 'I am the resurrection and the life. He who believes in Me, though he may die, he shall live.' " JOHN 11:25

TRUE OR FALSE:

1. "Now a certain man was sick, Lazarus of Bethany, the town of Mary and her sister Martha." JOHN 11:1
TRUE OR FALSE
2. "When Jesus heard that, He said, 'This sickness is not unto death, but for the glory of God, that the Son of God may be glorified through it.' " JOHN 11:4
TRUE OR FALSE
3. But Jesus did not like Martha or her sister or Lazarus. JOHN 11:5
TRUE OR FALSE

CIRCLE THE CORRECT WORDS:

4. "So, when He heard that he was sick, He stayed two more (YEARS, DAYS) in the place where He was." JOHN 11:6
5. "...He said to them, 'Our friend Lazarus (SLEEPS, WEEPS), but I go that I may wake him up.' " JOHN 11:11
6. "Then His disciples said, 'Lord, if he sleeps he will get well.' However, Jesus spoke of his (DEATH, DEBT), but they thought He was speaking about taking rest in sleep." JOHN 11:12-13

TRUE OR FALSE:

7. "So when Jesus came, He found that he had already been in the tomb four days." JOHN 11:17
TRUE OR FALSE
8. "Then Martha said to Jesus, 'Lord, if You had been here, my brother would not have died. But even now I know that whatever You ask of God, God will give You.' " JOHN 11:21-22
TRUE OR FALSE
9. "Jesus said to her, 'Your brother will rise again.' " JOHN 11:23
TRUE OR FALSE

CIRCLE THE CORRECT WORDS:

10. "Then when (MARY, RUTH) came where Jesus was, and saw Him, she fell down at His feet, saying to Him, 'Lord, if You had been here, my brother would not have died.' " JOHN 11:32
11. "Jesus (SLEPT, WEPT)." JOHN 11:35
12. "Then they took away the stone from the place where the dead man was lying. And Jesus lifted up His eyes and said, 'Father, I thank You that You have (SEEN, HEARD) Me.' " JOHN 11:41

TRUE OR FALSE:

13. "Now when He had said these things, He cried with a loud voice, 'Lazarus, come forth!' And he who had died came out bound hand and foot with graveclothes, and his face was wrapped with a cloth. Jesus said to them, 'Loose him, and let him go.' " JOHN 11:43-44
TRUE OR FALSE

207. JESUS RAISES LAZARUS

(JOHN 11:1-44)

R M P A K W H I J M Z Q T H E
K C M S E T E K F L K I L J Q
H B N T H I R T F S I P I T Z
D H R O T W J D O H U F N B U
P P S E S I A R P L B S E I A
T D B T N P S Y E D Z H E A N
B E D W C P T H O R F Z V J M
H B C F L W A U O E H I Q M G
R N O I T C E R R U S E R X F
U C U A A Q Z Q C U N V T T H
I P G N Q T S S L W G V A Y A
W O D M D A D S K M A B Q L W
L A Z A R U S I B J B Q F I B
V G D M C U J L Y N G Y H O P
B U T H N U Q S N S R E P V E

FIND THE WORDS THAT HAVE BEEN UNDERLINED BELOW

"I AM THE RESURRECTION AND THE LIFE."

JOHN 11:1-44

JESUS RAISES LAZARUS

DEATH

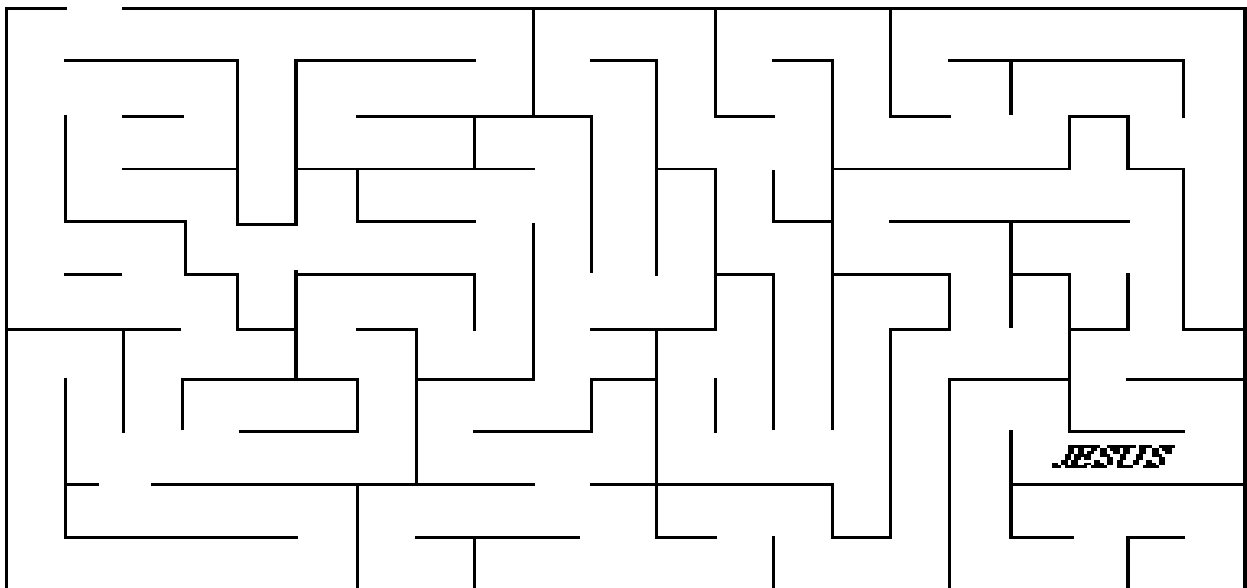

LIFE

207. JESUS RAISES LAZARUS

(JOHN 11:1-44)

MEMORY VERSE:

"Jesus said to her, 'I am the resurrection and the life. He who believes in Me, though he may die, he shall live.' " JOHN 11:25

TRUE OR FALSE:

1. "Now a certain man was sick, Lazarus of Bethany, the town of Mary and her sister Martha." JOHN 11:1
TRUE OR FALSE
2. "When Jesus heard that, He said, 'This sickness is not unto death, but for the glory of God, that the Son of God may be glorified through it.' " JOHN 11:4
TRUE OR FALSE
3. But Jesus did not like Martha or her sister or Lazarus. JOHN 11:5
TRUE OR FALSE

FILL IN THE BLANKS:

4. "So, when He heard that he was sick, He stayed two more _____ in the place where He was." JOHN 11:6
5. "...He said to them, 'Our friend Lazarus _____, but I go that I may wake him up.' " JOHN 11:11
6. "Then His disciples said, 'Lord, if he sleeps he will get well.' However, Jesus spoke of his _____, but they thought He was speaking about taking rest in sleep." JOHN 11:12-13

TRUE OR FALSE:

7. "So when Jesus came, He found that he had already been in the tomb four days." JOHN 11:17
TRUE OR FALSE
8. "Then Martha said to Jesus, 'Lord, if You had been here, my brother would not have died. But even now I know that whatever You ask of God, God will give You.' " JOHN 11:21-22
TRUE OR FALSE
9. "Jesus said to her, 'Your brother will rise again.' " JOHN 11:23
TRUE OR FALSE

FILL IN THE BLANKS:

10. "Then when _____ came where Jesus was, and saw Him, she fell down at His feet, saying to Him, 'Lord, if You had been here, my brother would not have died.' " JOHN 11:32
11. "Jesus _____." JOHN 11:35
12. "Then they took away the stone from the place where the dead man was lying. And Jesus lifted up His eyes and said, 'Father, I thank You that You have _____ Me.' " JOHN 11:41

TRUE OR FALSE:

13. "Now when He had said these things, He cried with a loud voice, 'Lazarus, come forth!' And he who had died came out bound hand and foot with graveclothes, and his face was wrapped with a cloth. Jesus said to them, 'Loose him, and let him go.' " JOHN 11:43-44
TRUE OR FALSE

207. JESUS RAISES LAZARUS

(JOHN 11:1-44)

H G C E F U E C M W U V W V E L O P T H A S S B B I J G A F
 I Q Z Y A P E A B D H E D E G D Q G G J Z F A G H C M N A I
 T C R T B W B Z P K I Z I M W N A G F K Y Z W D P J D Q O W
 J F D E R C D S R A P U C N K K E L I Z E Z I V N H U A W K
 H C Y Z B P V D Y G K U P B O A G Y Y W K E L Z Z M N F E O
 B J Q Q E R N I R S R I L A E U A T M W G S V Y P U N W T W
 C K Q V W F N G E A L L A H S W T P R V Z G U O L J R E E F
 G V H L G M P P B U E B O S I K N V A L S Y A R I H S J P U
 H O F S H E Y C V K N Q W P L Y B E A H B M G C F G C N C A
 G B O R E T G V S S A B H W D Y K Z U W E X O C E Q R Q V H
 Q Y I T F S N U T E I V O J S E A N V S W O J U A J G A T O
 P D H S Z U H E O Y V B P H U R L J W R G L D B K W W B S D
 C E H B A S W I J X P E E N U H D A A V B F E R R L K M B B
 P G H B N E Y P Q F Q I I S J L O H L I V E Q A W Q G M Q K
 Q C Q Z S J Z N L L D W D L L B H N T B T W I B O P Q J B S
 B B B F H L U S P K F Y Q F E R Y Y Z K D S W P Y W N L M L
 V E F W U M G C V I R B J G J B Q W V G E U D I K E G F I Z
 L K B B S M E N G Q C K J I T O K C K S P U U Y Z T H Z T I
 I Y M Y Y E F P Y S G Y C N B W G N B P T Y A V U F W A N C
 J B N L J Z Y C Q S O H B O V H O R M E C T H O U G H P B D
 I Z V N N I I B D O W F V I Q J J G S I P O B N M O Z M P C
 C U S D D I F C O M A Q D T O S M I H N N L C W P R G B Y Q
 J E L C Y D B B O E J X I C V R N K J A B P Q E G U V R P U
 H F H V I Z L P K Z V H M E Y V R F L V I Z K H K A K Z Z W
 L J B T Y P A R P P H M O R B J M T B I V P H Z L M C F I W
 Q U M O A Z E E Z E Y G O R C D I S B W G Z C J W Q B I C Q
 H B I S M V Z M S U G Q F U J U F T K A U B H Q B P E A B B
 Y K O K B U C H T V M W U S N V J O N M K N L B K B T B K A
 O B B L L D L Y V F B G D E B C Q Y P H J P U M N T N N L F
 F D K D O W W Y G I U B I R L G E T F L W T A G I H R V W S

FIND THE UNDERLINED WORDS WRITTEN BELOW IN THE PUZZLE ABOVE

JESUS RAISES LAZARUS

"I AM THE RESURRECTION AND THE LIFE. HE WHO BELIEVES IN ME,

THOUGH HE MAY DIE, HE SHALL LIVE."

JOHN 11:25

DEATH

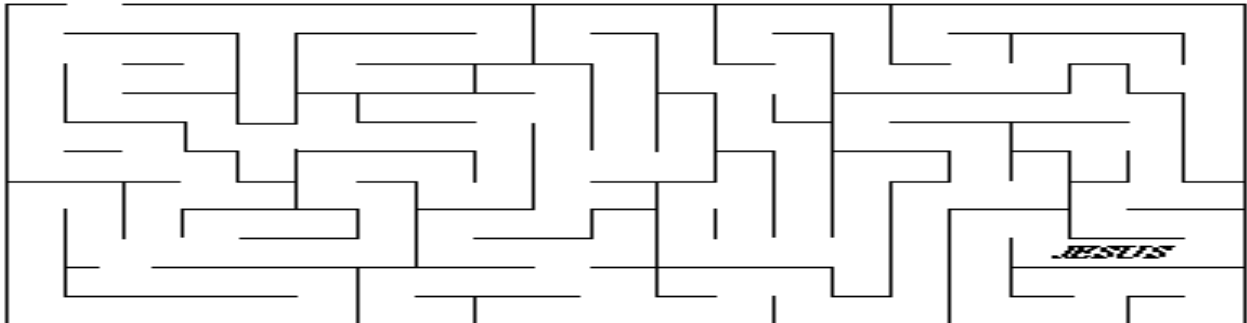

LIFE

207. JESUS RAISES LAZARUS

(JOHN 11:1-44)

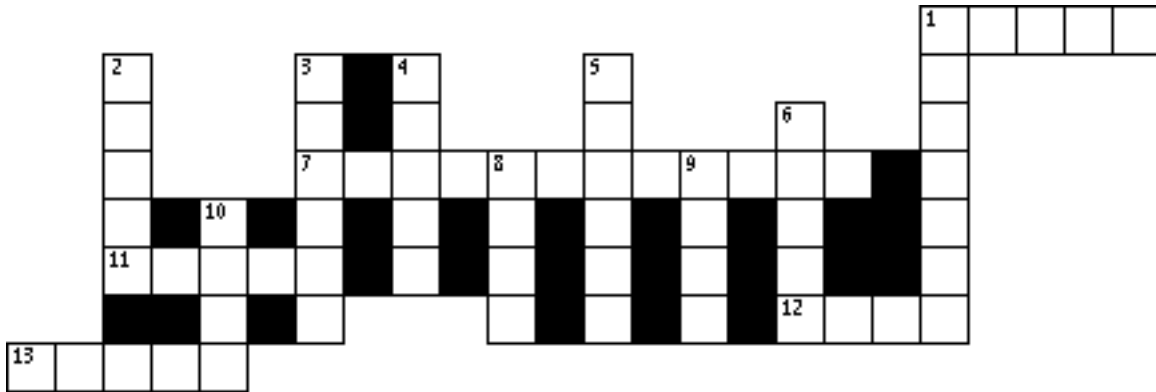

- 1 DOWN "Now a certain man was sick, _____ of Bethany, the town of Mary and her sister Martha." **JOHN 11:1**
- 13 ACROSS "When Jesus heard that, He said, 'This sickness is not unto death, but for the _____ of God, that the Son of God may be glorified through it.'" **JOHN 11:4**
- 6 DOWN "Now Jesus _____ Martha and her sister and Lazarus." **JOHN 11:5**
- 12 ACROSS "So, when He heard that he was sick, He stayed two more _____ in the place where He was." **JOHN 11:6**
- 5 DOWN "...He said to them, 'Our friend Lazarus _____, but I go that I may wake him up.'" **JOHN 11:11**
- 11 ACROSS "Then His disciples said, 'Lord, if he sleeps he will get well.' However, Jesus spoke of his _____, but they thought He was speaking about taking rest in sleep." **JOHN 11:12-13**
- 9 DOWN "So when Jesus came, He found that he had already been in the _____ four days." **JOHN 11:17**
- 3 DOWN "Then _____ said to Jesus, 'Lord, if You had been here, my brother would not have died. But even now I know that whatever You ask of God, God will give You.'" **JOHN 11:21-22**
- 8 DOWN "Jesus said to her, 'Your brother will _____ again.'" **JOHN 11:23**
- 7 ACROSS "Jesus said to her, 'I am the _____ and the life. He who believes in Me, though he may die, he shall live.'" **JOHN 11:25**
- 10 DOWN "Then when _____ came where Jesus was, and saw Him, she fell down at His feet, saying to Him, 'Lord, if You had been here, my brother would not have died.'" **JOHN 11:32**
- 4 DOWN "_____ wept." **JOHN 11:35**
- 2 DOWN "Then they took away the stone from the place where the dead man was lying. And Jesus lifted up His eyes and said, 'Father, I thank You that You have _____ Me.'" **JOHN 11:41**
- 1 ACROSS "Now when He had said these things, He cried with a loud voice, 'Lazarus, come forth!' And he who had died came out bound hand and foot with graveclothes, and his face was wrapped with a cloth. Jesus said to them, '_____ him, and let him go.'" **JOHN 11:43-44**

Bible Story 208

**THE
GOOD
SAMARITAN**

LUKE 10:25-37



"The good Samaritan has compassion on the man who had been beaten."
Luke 10:25-37

208. THE GOOD SAMARITAN (LUKE 10:25-37)

MEMORY VERSE:

"Blessed are the merciful, for they shall obtain mercy. Blessed are the pure in heart, for they shall see God." MATTHEW 5:7-8

TRUE OR FALSE:

1. "And behold, a certain lawyer stood up and tested Him, saying, 'Teacher, what shall I do to inherit eternal life?' " **LUKE 10:25**

TRUE OR FALSE

Jesus told this parable...

CIRCLE THE CORRECT WORDS:

2. "...A certain man went down from Jerusalem to Jericho, and fell among (**FRIENDS, THIEVES**), who stripped him of his clothing, wounded him, and departed, leaving him half dead." **LUKE 10:30**
3. "Now by chance a certain (**PRIEST, TEACHER**) came down that road. And when he saw him, he passed by on the other side." **LUKE 10:31**
4. "Likewise a (**DANITE, LEVITE**), when he arrived at the place, came and looked, and passed by on the other side." **LUKE 10:32**
5. "But a certain (**SAMARITAN, EGYPTIAN**), as he journeyed, came where he was. And when he saw him, he had compassion on him." **LUKE 10:33**

TRUE OR FALSE:

6. "...and went to him and bandaged his wounds, pouring on oil and wine; and he set him on his own animal, brought him to an inn, and took care of him." **LUKE 10:34**
TRUE OR FALSE
7. On the next day, he told the innkeeper, "I have done all I am going to do for this man." **LUKE 10:35**
TRUE OR FALSE

CIRCLE THE CORRECT WORDS:

8. "So which of these three do you think was (**NEIGHBOR, EVIL**) to him who fell among the thieves?" **LUKE 10:36**
9. "And he said, 'He who showed mercy on him.' Then Jesus said to him, 'Go and do (**LIKEWISE, OTHERWISE**).'" **LUKE 10:37**

208. THE GOOD SAMARITAN

(LUKE 10:25-37)

I	V	D	P	L	Z	S	E	V	E	I	H	T	K	T
N	M	D	T	N	B	J	G	W	Z	Y	O	S	G	B
T	T	V	I	O	O	T	G	A	M	D	W	S	L	E
M	F	D	L	H	R	Z	B	W	M	A	D	O	O	A
L	N	M	E	Y	B	D	V	W	M	U	E	I	M	T
N	W	O	V	M	E	E	S	Z	I	Q	B	B	T	E
T	Y	V	I	Z	B	N	S	O	Z	C	B	N	S	N
H	F	N	T	S	J	E	R	B	O	N	O	A	E	H
T	E	E	E	D	S	E	F	U	J	L	R	T	I	H
P	D	I	H	C	T	A	R	A	O	B	P	I	R	G
N	R	G	N	V	C	D	P	I	U	J	Y	R	P	J
C	L	H	N	D	O	O	G	M	C	C	V	A	L	J
B	B	B	S	E	N	C	A	W	O	H	Z	M	T	H
F	H	O	K	K	P	C	V	V	B	C	O	A	T	V
O	F	R	Y	B	O	L	S	Z	O	E	Y	S	J	F

BEATEN
 COMPASSION
 GOOD
 JERICHO

JOURNEY
 LEVITE
 NEIGHBOR
 PRIEST

ROBBED
 SAMARITAN
 THIEVES

START

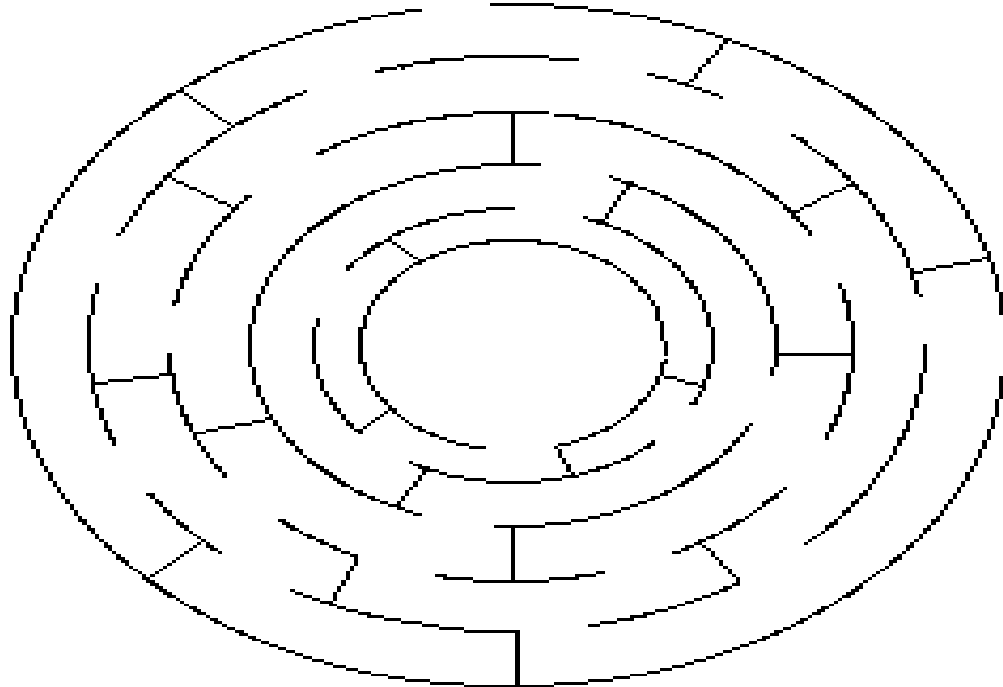

208. THE GOOD SAMARITAN (LUKE 10:25-37)

MEMORY VERSE:

"Blessed are the merciful, for they shall obtain mercy. Blessed are the pure in heart, for they shall see God." MATTHEW 5:7-8

TRUE OR FALSE:

1. "And behold, a certain lawyer stood up and tested Him, saying, 'Teacher, what shall I do to inherit eternal life?' " **LUKE 10:25**

TRUE OR FALSE

Jesus told this parable...

FILL IN THE BLANKS:

2. "...A certain man went down from Jerusalem to Jericho, and fell among _____, who stripped him of his clothing, wounded him, and departed, leaving him half dead." **LUKE 10:30**
3. "Now by chance a certain _____ came down that road. And when he saw him, he passed by on the other side." **LUKE 10:31**
4. "Likewise a _____, when he arrived at the place, came and looked, and passed by on the other side." **LUKE 10:32**
5. "But a certain _____, as he journeyed, came where he was. And when he saw him, he had compassion on him." **LUKE 10:33**

TRUE OR FALSE:

6. "...and went to him and bandaged his wounds, pouring on oil and wine; and he set him on his own animal, brought him to an inn, and took care of him." **LUKE 10:34**
TRUE OR FALSE
7. On the next day, he told the innkeeper, "I have done all I am going to do for this man." **LUKE 10:35**
TRUE OR FALSE

FILL IN THE BLANKS:

8. "So which of these three do you think was _____ to him who fell among the thieves?"
LUKE 10:36
9. "And he said, 'He who showed mercy on him.' Then Jesus said to him, 'Go and do _____.'" **LUKE 10:37**

208. THE GOOD SAMARITAN

(LUKE 10:25-37)

Z B Q F I J N E S J K J I E S N P B T Y M Z Z U E V N T N R
 E V Y P C J J K H L U W Y G F H Y L U F Q U O S L V N J C C Y
 B S B Z V G E N G D Y S J Q Y K B Z N Q T C M N E K R A I P
 P B S H S O W J J W E B D B K I P U C N Y U I Y L O K P P U
 G B U S J H U Y B S U D W B E M Z R C V E W C V B W K P M I
 U W F T P G K G B R A N Y L R I R G O Q E O U B Y B A M H Q
 B H B N C B P K S R N D H P Q T B D M D N R E J E U D W M R
 A R I V E R W E E V L Q S U K J D G P A Q D J A C D H M E K
 U T Z H B O Z I L Y B W M Z K D O H A N S H Y G V Y A D G C
 W C A N R M K K T B Y J K N V C G U S E F Q K I Q Q S A N V
 Z H K Y N H S E U D E T Y U B N U F S V F P N I J S Q E H I
 F Q W C Q R Q I D D B U O Q J U U F I T K O B F W D T N E J
 W I B M S N V S J I R B H V P A R S O E E K O A U G U J F S
 V W D R P N Z I I N A P Y I U G W R N N H K J S X O E P C U
 F T B C Z Z R R I B G D C Z V M G Z B Y I U I F J R D Y S D
 H L R B B Y D E U F T T R S U F G W Y L G H B Y I N M Q N S
 U J H C K Z R B G N I V E L E T I V E L T S E C N H S Q Z J
 B D Z F E K C N Z J O P M C M V L N Q H M E H V E Q B Y H O
 T U B E V B N P E M Y T I K V S N B I A D O G L T H Q C M U
 B J V B K G Y V G P M D Q W S J K E R N Z B B M T A Y G D R
 G U B Q E Z I W M Y B P K Q E I V B F Z N F V O Q J T P E N
 H S J Q W L R W S B W U L B B E Y K V Q S Z W M O B R O W E
 E H A R B K P N O A S T Z G S B B N K C I S H V S I N F E Y
 C T R M K J H D K N N Q M E J V B O G P V Q W Z E O V B Z Z
 R N K V A P B F T D S L M N P D K C P W W G Q S B C H B Z Y
 M T P Q K R Y A A A I Y N D D V U H W R P H T Y M F B R H H
 S V L M W N I W S G M I K A W T Q Z D A C C I C Z D M Z R K
 Z F M L Y N D T E E M G O I W J I O Y B P B B E Y G H A V G
 W Y D I E F K A A D Z R F L C B O N E T A E B N H V L E Q D
 I I R N R J S M C N K Q A W B G L M T W Y Q F T W Y B M P J

BANDAGED

JOURNEY

ROAD

BEATEN

LEVITE

ROBBED

COMPASSION

MERCY

SAMARITAN

GOOD

PRIEST

THIEVES

JERICO

START

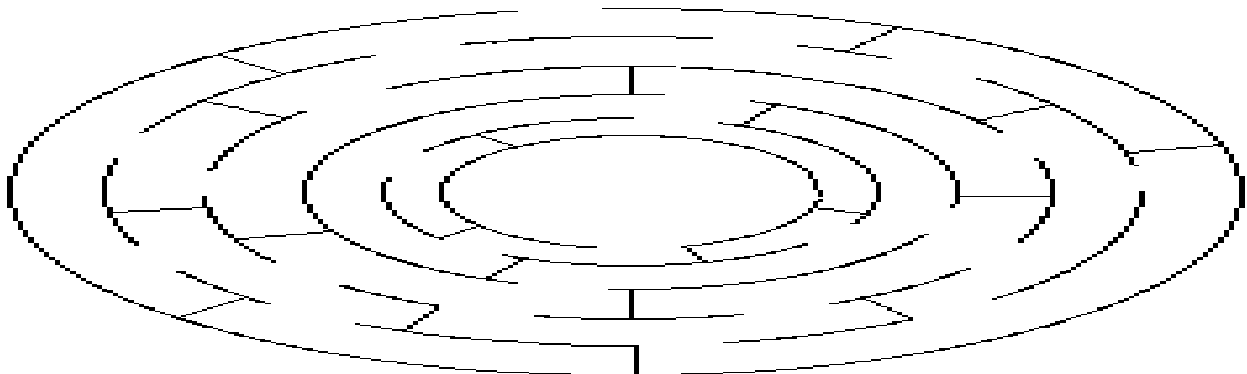

208. THE GOOD SAMARITAN

(LUKE 10:25-37)

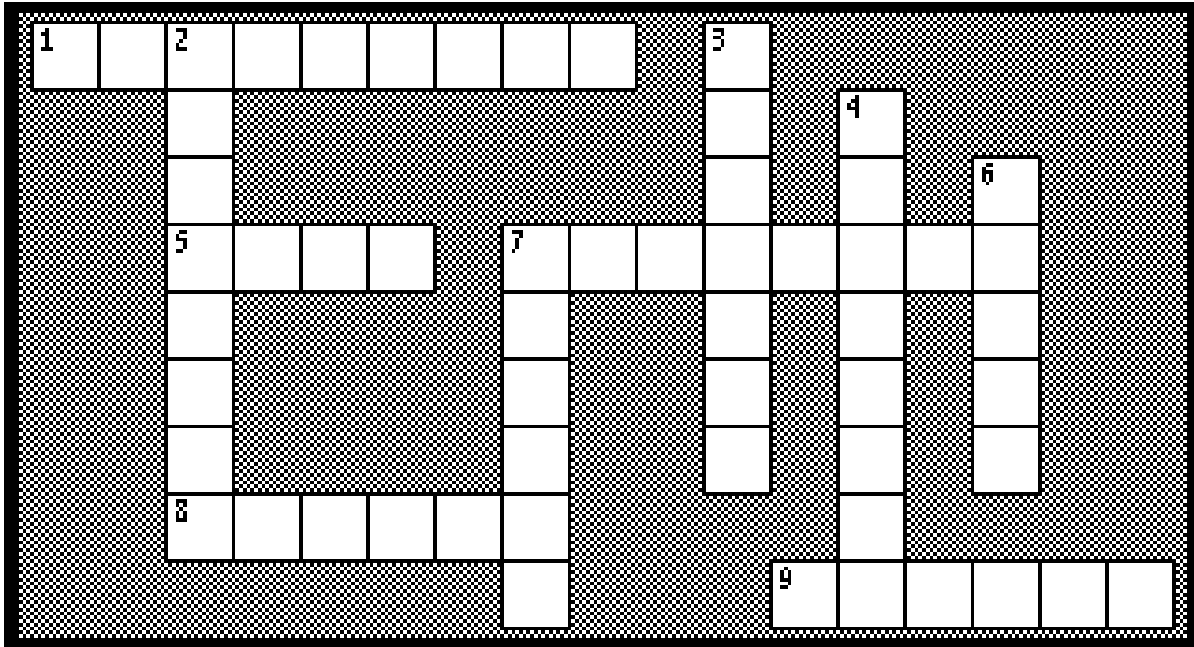

- 2 DOWN "Blessed are the _____, for they shall obtain mercy. Blessed are the pure in heart, for they shall see God." **MATTHEW 5:7-8**
- 7 DOWN "And behold, a certain _____ stood up and tested Him, saying, 'Teacher, what shall I do to inherit eternal life?' " **LUKE 10:25**
- 3 DOWN "...A certain man went down from Jerusalem to Jericho, and fell among _____, who stripped him of his clothing, wounded him, and departed, leaving him half dead." **LUKE 10:30**
- 9 ACROSS "Now by chance a certain _____ came down that road. And when he saw him, he passed by on the other side." **LUKE 10:31**
- 8 ACROSS "Likewise a _____, when he arrived at the place, came and looked, and passed by on the other side." **LUKE 10:32**
- 1 ACROSS "But a certain _____, as he journeyed, came where he was. And when he saw him, he had compassion on him." **LUKE 10:33**
- 5 ACROSS "...and went to him and bandaged his wounds, pouring on oil and wine; and he set him on his own animal, brought him to an inn, and took _____ of him." **LUKE 10:34**
- 6 DOWN "...Take care of him; and whatever more you spend, when I come again, I will _____ you.'" **LUKE 10:35**
- 4 DOWN "So which of these three do you think was _____ to him who fell among the thieves?" **LUKE 10:36**
- 7 ACROSS "And he said, 'He who showed mercy on him.' Then Jesus said to him, 'Go and do _____.'" **LUKE 10:37**

Bible Story 209

**JESUS VISITS
MARY &
MARTHA**

LUKE 10:38-42

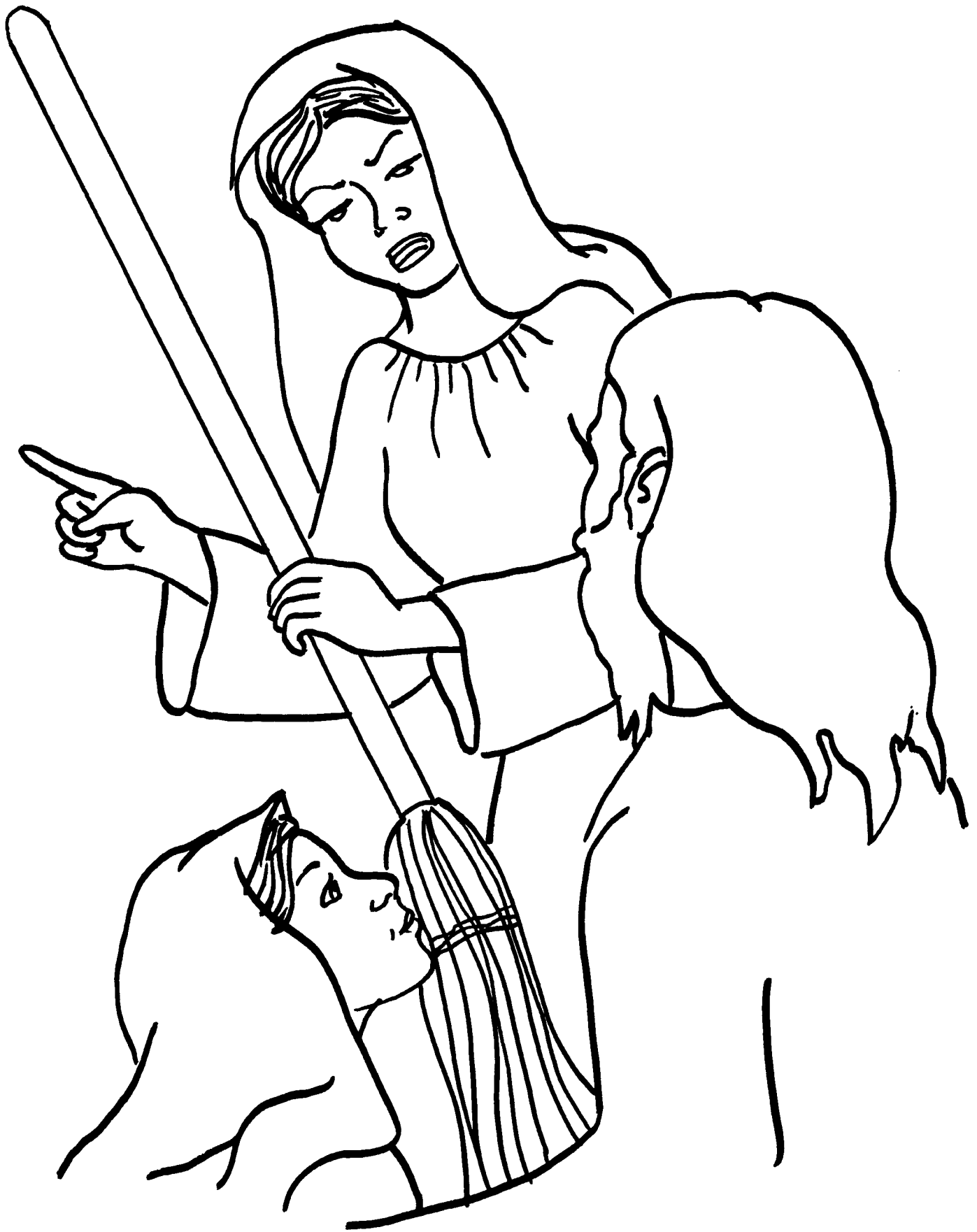

"Jesus Visits Mary and Martha."
Luke 10:38 -42

209. JESUS VISITS MARY AND MARTHA

(LUKE 10:38-42)

MEMORY VERSE:

"Give unto the LORD the glory due to His name; worship the LORD in the beauty of holiness." PSALM 29:2

TRUE OR FALSE:

1. "...He entered a certain village; and a certain woman named Martha welcomed Him into her house." **LUKE 10:38**

TRUE OR FALSE

2. "And she had a sister called Mary, who also sat at Jesus' feet and heard His word." **LUKE 10:39**

TRUE OR FALSE

CIRCLE THE CORRECT WORD:

3. "But Martha was distracted with (MUCH, SOME) serving..." **LUKE 10:40**

TRUE OR FALSE:

4. "...and she approached Him and said, 'Lord, do You not care that my sister has left me to serve alone?' " **LUKE 10:40**

TRUE OR FALSE

CIRCLE THE CORRECT WORD:

5. "...Therefore tell her to (LEAVE, HELP) me." **LUKE 10:40**

TRUE OR FALSE:

6. And Jesus answered and said to her, "Martha, Martha, you are never worried or troubled." **LUKE 10:41**

TRUE OR FALSE

7. "...But one thing is needed, and Mary has chosen that good part, which will not be taken away from her." **LUKE 10:42**

TRUE OR FALSE

209. JESUS VISITS MARY AND MARTHA

(LUKE 10:38-42)

Q	Q	E	C	M	Y	R	Z	Y	D	I	P	B	F	Q
G	F	Q	T	P	I	C	V	N	E	L	U	P	Z	B
Y	T	G	B	M	A	B	B	B	D	Q	M	D	W	B
R	N	A	N	H	W	R	O	J	E	S	J	J	G	V
N	A	N	D	W	Z	R	T	J	E	Z	Y	P	Z	H
G	B	D	C	V	L	N	A	T	N	G	B	R	T	S
W	T	O	Y	H	M	V	O	U	H	I	O	D	A	T
R	I	B	N	V	O	N	D	B	E	K	J	Q	T	M
E	T	D	T	E	O	S	H	O	G	W	R	A	J	O
B	L	L	T	N	H	O	E	N	O	B	O	F	G	L
S	K	H	S	I	A	L	I	N	A	G	Z	A	A	S
A	A	V	F	C	S	H	B	G	T	N	G	H	Z	T
T	W	G	B	B	T	O	W	J	E	K	E	D	T	R
T	Q	L	Y	N	B	B	B	V	H	C	C	W	U	B
E	I	J	Z	Z	D	Z	K	N	D	H	J	Y	J	Z

FIND THE WORDS OF THE VERSE BELOW IN THE PUZZLE ABOVE

"BUT ONE THING IS NEEDED, AND MARY HAS CHOSEN THAT GOOD PART" LUKE 10:42

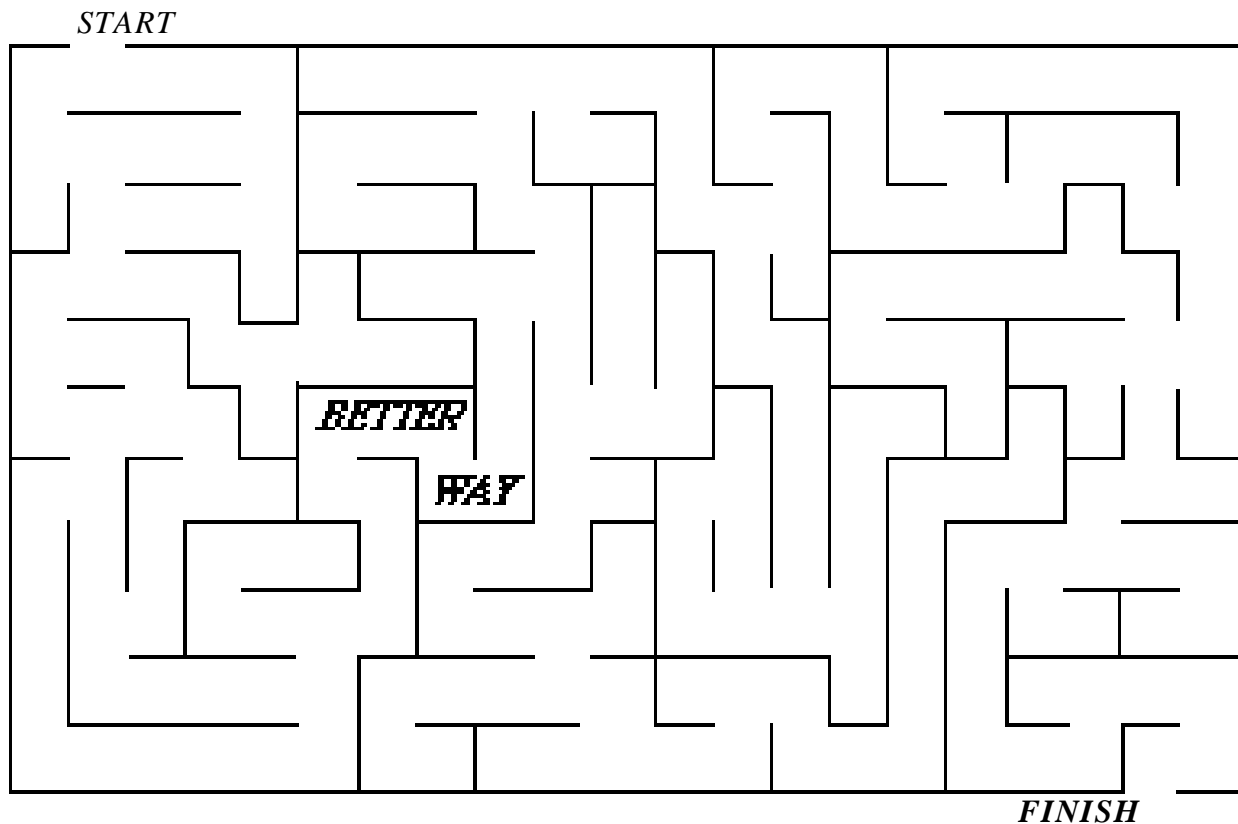

209. JESUS VISITS MARY AND MARTHA

(LUKE 10:38-42)

MEMORY VERSE:

"Give unto the LORD the glory due to His name; worship the LORD in the beauty of holiness." PSALM 29:2

TRUE OR FALSE:

1. "...He entered a certain village; and a certain woman named Martha welcomed Him into her house." **LUKE 10:38**

TRUE OR FALSE

2. "And she had a sister called Mary, who also sat at Jesus' feet and heard His word." **LUKE 10:39**

TRUE OR FALSE

FILL IN THE BLANK:

3. "But Martha was distracted with _____ serving..." **LUKE 10:40**

TRUE OR FALSE:

4. "...and she approached Him and said, 'Lord, do You not care that my sister has left me to serve alone?' " **LUKE 10:40**

TRUE OR FALSE

FILL IN THE BLANK:

5. "...Therefore tell her to _____ me." **LUKE 10:40**

TRUE OR FALSE:

6. And Jesus answered and said to her, "Martha, Martha, you are never worried or troubled." **LUKE 10:41**

TRUE OR FALSE

7. "...But one thing is needed, and Mary has chosen that good part, which will not be taken away from her." **LUKE 10:42**

TRUE OR FALSE

209. JESUS VISITS MARY AND MARTHA

(LUKE 10:38-42)

F M M B T C G Q R R L R I K P B C Y S B L J H P U V Y V E E
 Z J G O N B T Q B J Y O O W E S E B Z F N P Q S S M U L F D
 V C U N Y B E H N Z L J V W I M U C R P J A Z B D V F V Z C
 K M U C B Y L V G F H L M B P H Z M L N O V T U E O I R L V
 C Y O B P U S Z B J B L G L L V B U U I I T W D B V E E V H
 D S V B B W V U L F K A D R E Y E A C D M P V Z B O O R O H
 Q O V I U D P D G E K G O Q P B Q K R L U G B O U F Z T L A
 L J R F L O Z F N S B D T C K L A I K Y R A M B Q B E G Z H
 O I F A N K S H I O I H E R S M L L G G E F W U J J O Q J B
 J M W W Z J M G H R D G C D N E B O W R H K M O A O R S P E
 W O P B H Q B U T I O N U H E J F Z T A Z K V B D P A R T U
 Z Y W B R B B E L Y F W V N U E H I T O D O Z T D Y I W E D
 N D V Y A Z A Q N S B B N N W L N J D F N C Q L I T Y S N J
 Z V G K A P K J B Y Q W V V S D V Z C W C T B R O B M J R T
 C U J Y J Q I V Z D R B L G C Z E T V V A N U F B H S R B Q
 U B T T Y L Y Q S Y K L M R T P L T S B B B W F E Q I Q I B
 Z S F P G A T D V B I V U K P E T I B Q F U D D O A L U R U
 H S G S H L F D M W D B O Z M B C H K J L Q N Z N E N S B V
 Z O J J S L Z D O O F H B L S L J J A C I A Y R R D D O V D
 M V W V E M B V N J H C M B D I I I Y T H D N F L B E K S E
 U Z J D Q S C V G C L O G I Q A T J F N E K A T B N G S D H
 D D H T M O S D I V D Y Q V H I B B D A V Y K M O I W J R M
 D C G T B A L K C G I K O V E R I B Q S M C P C D Z Z F F U
 V B B Q N A W B N W P E H T N O U R N B E Z H R V F A R N N
 V O A F E L S A E H M O C L P N K B N W Y Y Q I Z A K C V C
 L P B N S K N S Y H W J I C T M B Q F D Y S O P R B U T V A
 C O H F O N P H B B L S H M L T O K Y I S V Z Z K K Z R B J
 L R P T H H M P P B G Z W G Z V B R V A Q B F V E Q E L W K
 V J T H C M A P U B S N T K T B F L F J K T L Q G S A S J R
 N Y Q D B G N S U U Z W H M T K A E Y T Y G Q Q I W H P B L

FIND THE WORDS OF THE VERSE BELOW IN THE PUZZLE ABOVE

"But one thing is needed, and Mary has chosen that good part, which will not be taken away from her." LUKE 10:42

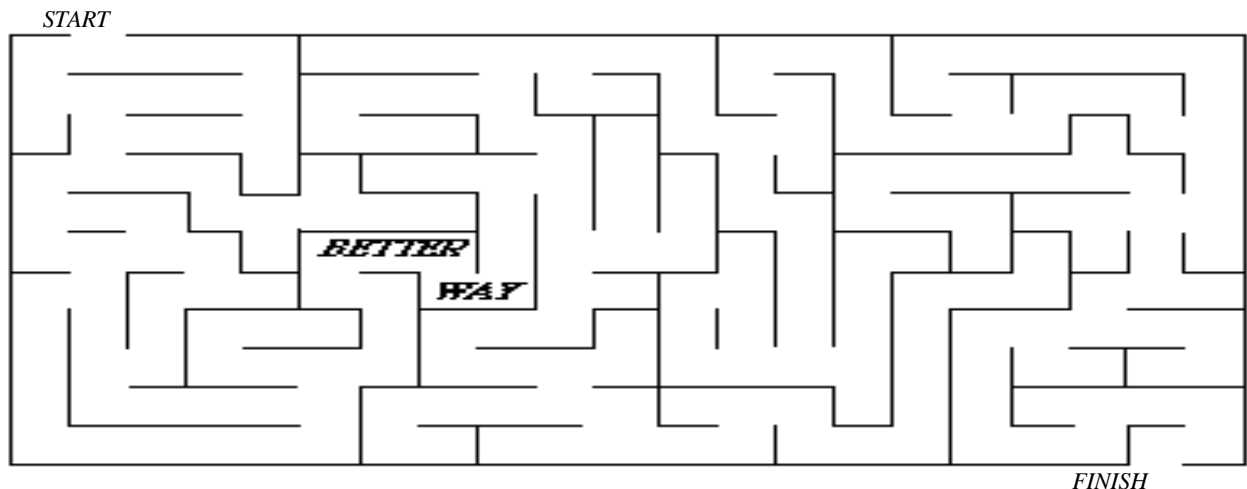

FINISH

209. JESUS VISITS MARY AND MARTHA

(LUKE 10:38-42)

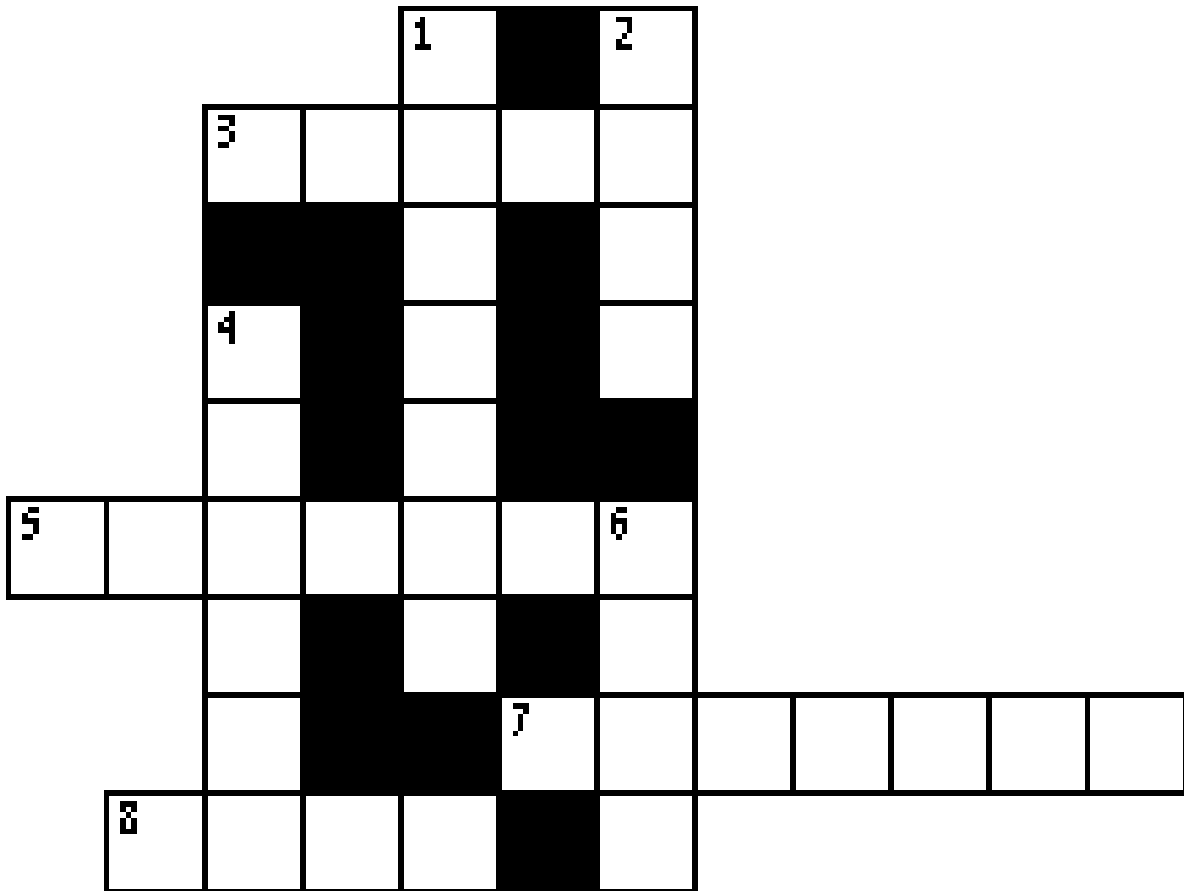

- 1 DOWN "Give unto the LORD the glory due to His name; _____ the LORD in the beauty of holiness." **PSALM 29:2**
- 4 DOWN "...He entered a certain village; and a certain woman named _____ welcomed Him into her house." **LUKE 10:38**
- 8 ACROSS "And she had a sister called _____, who also sat at Jesus' feet and heard His word." **LUKE 10:39**
- 5 ACROSS "But Martha was distracted with much _____..." **LUKE 10:40**
- 3 ACROSS "...and she approached Him and said, 'Lord, do You not care that my sister has left me to serve _____?'" **LUKE 10:40**
- 2 DOWN "...Therefore tell her to _____ me." **LUKE 10:40**
- 7 ACROSS "And Jesus answered and said to her, 'Martha, Martha, you are _____ and troubled about many things.'" **LUKE 10:41**
- 6 DOWN "...But one thing is needed, and Mary has chosen that _____ part, which will not be taken away from her." **LUKE 10:42**

Bible Story 210

THE PRODIGAL SON

LUKE 15:11-32



"Jesus told the parable of the prodigal son."
Luke 15:11-32

210. THE PRODIGAL SON

(LUKE 15:11-32)

MEMORY VERSE:

"...for this my son was dead and is alive again; he was lost and is found..." LUKE 15:24

A certain man had two sons...

TRUE OR FALSE:

1. "And the younger of them said to his father, 'Father, give me the portion of goods that fall to me.' So he divided to them his livelihood." LUKE 15:12

TRUE OR FALSE

2. "...the younger son gathered all together, journeyed to a far country, and there wasted his possessions with prodigal living." LUKE 15:13

TRUE OR FALSE

CIRCLE THE CORRECT WORDS:

3. "But when he had spent (**SOME**, **ALL**), there arose a severe famine in that land, and he began to be in want." LUKE 15:14

4. "Then he went and joined himself to a citizen of that country, and he sent him into his fields to feed (**SWINE**, **HORSES**)." LUKE 15:15

TRUE OR FALSE:

5. "...no one gave him anything." LUKE 15:16

TRUE OR FALSE

CIRCLE THE CORRECT WORDS:

6. "I will arise and go to my father, and will say to him, 'Father, I have sinned against heaven and before you, and I am no longer worthy to be called your (**SON**, **SWINE**). Make me like one of your hired servants.'" LUKE 15:18-19

7. "And he arose and came to his father. But when he was still a great way off, his father saw him and had compassion, and (**WALKED**, **RAN**) and fell on his neck and kissed him." LUKE 15:20

FILL IN THE BLANKS:

8. "But the father said to his servants, 'Bring out the best robe and put it on him, and put a ring on his hand and sandals on his feet. And bring the fatted calf here and kill it, and let us eat and be merry; for this my son was _____ and is _____ again; he was lost and is found.'..." LUKE 15:22-24

TRUE OR FALSE:

9. "Now his older son was in the field. And as he came and drew near to the house, he heard music and dancing. So he called one of the servants and asked what these things meant." LUKE 15:25-26

TRUE OR FALSE

10. And he was excited and went in. LUKE 15:28

TRUE OR FALSE

FILL IN THE BLANKS:

11. "And he said to him, 'Son, you are always with me, and all that I have is yours. It was right that we should make merry and be glad, for your brother was dead and is alive again, and was _____ and is _____.'" LUKE 15:31-32

210. THE PRODIGAL SON

(LUKE 15:11-32)

C	H	O	K	C	H	M	E	W	F	H	U	E	U	W
P	Y	B	Y	Z	Q	I	Z	B	A	U	P	Z	A	W
Q	O	Y	A	R	U	O	S	Y	B	S	W	S	D	Y
B	F	N	B	D	D	A	E	D	R	Y	C	A	W	Z
V	D	D	Z	N	W	B	Q	L	B	J	P	N	E	U
L	G	S	M	Y	I	K	V	N	E	N	R	D	E	G
I	Q	I	U	Y	F	A	L	D	F	O	R	L	B	F
J	C	H	F	Q	U	E	G	C	W	D	O	I	D	Y
C	F	T	J	Q	M	Y	S	A	G	S	F	I	V	I
J	C	G	S	H	N	E	R	V	T	F	O	U	N	D
I	S	I	U	E	H	V	S	O	F	Y	M	D	N	F
N	J	C	B	F	V	I	B	S	Z	I	E	Z	P	B
H	O	B	K	O	S	L	B	K	A	B	T	P	Y	L
L	K	S	B	I	L	A	Z	L	N	L	L	Z	G	A
Q	V	E	D	H	B	T	F	D	S	O	M	V	N	E

FIND THE WORDS OF THE VERSE BELOW IN THE PUZZLE ABOVE

"For this my son was dead and is alive again; he was lost and is found."
LUKE 15:24

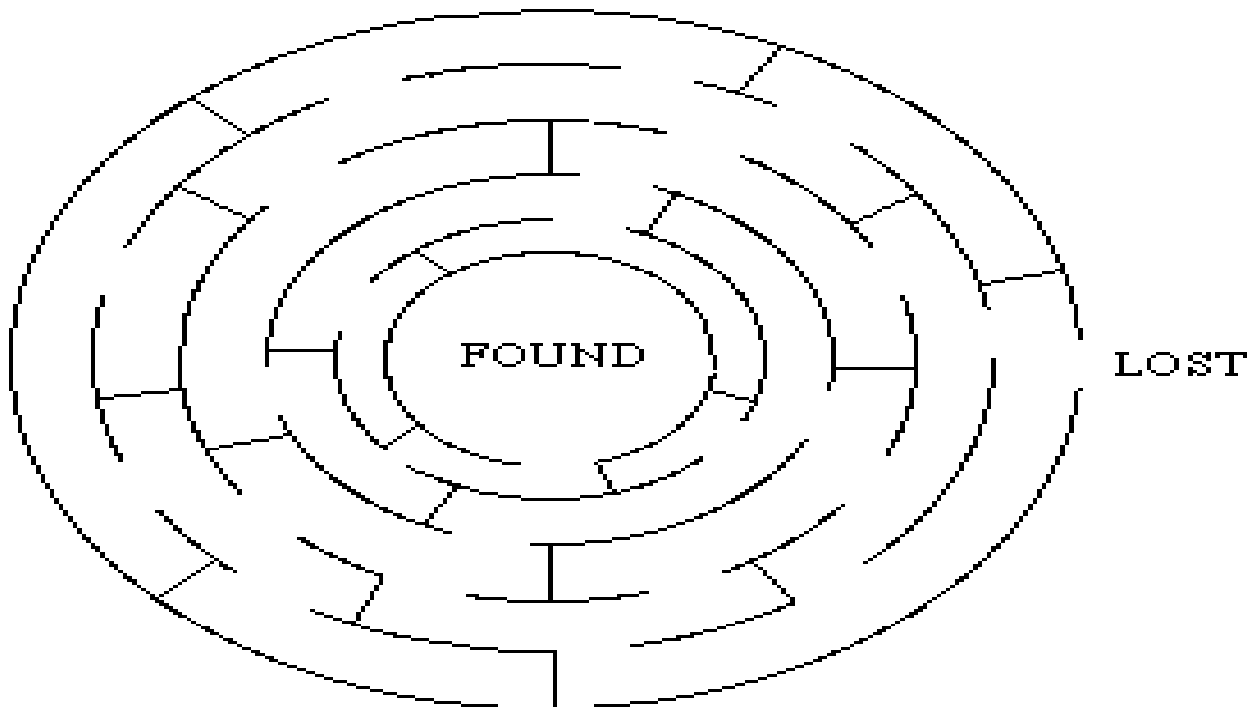

210. THE PRODIGAL SON

(LUKE 15:11-32)

MEMORY VERSE:

"...for this my son was dead and is alive again; he was lost and is found..." LUKE 15:24

A certain man had two sons...

TRUE OR FALSE:

1. "And the younger of them said to his father, 'Father, give me the portion of goods that fall to me.' So he divided to them his livelihood." LUKE 15:12

TRUE OR FALSE

2. "...the younger son gathered all together, journeyed to a far country, and there wasted his possessions with prodigal living." LUKE 15:13

TRUE OR FALSE

FILL IN THE BLANKS:

3. "But when he had spent _____, there arose a severe famine in that land, and he began to be in want." LUKE 15:14

4. "Then he went and joined himself to a citizen of that country, and he sent him into his fields to feed _____." LUKE 15:15

TRUE OR FALSE:

5. "...no one gave him anything." LUKE 15:16

TRUE OR FALSE

FILL IN THE BLANKS:

6. "I will arise and go to my father, and will say to him, 'Father, I have sinned against heaven and before you, and I am no longer worthy to be called your _____. Make me like one of your hired servants.'" LUKE 15:18-19

7. "And he arose and came to his father. But when he was still a great way off, his father saw him and had compassion, and _____ and fell on his neck and kissed him." LUKE 15:20

8. "But the father said to his servants, 'Bring out the best robe and put it on him, and put a ring on his hand and sandals on his feet. And bring the fatted calf here and kill it, and let us eat and be merry; for this my son was _____ and is _____ again; he was lost and is found.'..." LUKE 15:22-24

TRUE OR FALSE:

9. "Now his older son was in the field. And as he came and drew near to the house, he heard music and dancing. So he called one of the servants and asked what these things meant." LUKE 15:25-26

TRUE OR FALSE

10. And he was excited and went in. LUKE 15:28

TRUE OR FALSE

FILL IN THE BLANKS:

11. "And he said to him, 'Son, you are always with me, and all that I have is yours. It was right that we should make merry and be glad, for your brother was dead and is alive again, and was _____ and is _____.'" LUKE 15:31-32

210. THE PRODIGAL SON

(LUKE 15:11-32)

S R L P U V W C V V T B A J Y B V U O B T T Z V K R B M Q D
 B S Q R C T S O L B G I B O V H W L R C C B I M C E P G G U
 O M K M H T Y H S I R D Y B F G B M H V O K V T V E F H T Q
 S R E A E Y D H H F R A Z F D A P O P C B Q I Q H O T A H K
 B M K U Q E C O D R K M R O Q K F T N A U A J S B D N I S N
 H C H L J R P F O B U D Q B D E A J T W M Q S U T E A O Y J
 G T Y M S B L F L L P I V V I N B B Y Z P T V G F A F Y Z R
 Q Q B I B W R B H Y S R E E D C E H L Z A V Q G Z F W A U B
 P F H I B S Z B Z E Q G Y H B B G Z C E J I O B F V B E B W
 C T J F H A P Z E Q V K B C V C E J O T Y J D H H A V H T K
 H D V L Z W D G S T Y F P K W C G V Y A N D B G Z S N Q O F
 H N I G Y I H F Q B E Q F Z Z T H L I Q K I S B P V F O U N
 E G E B Q B M B B B Z N O M F B B L Y L Q Z Q W R B K B H R
 H V A B P U Y C Z B P I U J O W Y B C H A V S N U Z B C E N
 J G A V V W U B F S A G N A J R B Y Y D K L F E K P S C D B
 K K Q Z M N K Z N I U J D P L S A C D D Y G B S B N F C C I
 I Z X Y V Y S A M S Y L B N N Q P Z W S O N C B A S H Z P D
 M D P U O D S K F B E D N E A U E A S F O D A E D Z E J W M
 Z I F V T H V I I W D K Y P Y R U J A N Y N L B H I Y S B L
 Q Y M M J I Y L E J K G Q B O G R L B V D Y J M A T E Z Z D
 S I G Y W I Z U V F J C Q U P L B T T W Y T Y I S J D D K H
 V N E A A A N H M K Y M F U B Y M A Q T U I C D O B J U I Q
 H A W J S L O B N G Y B E H E F K E T U O T L L N I B M I C
 M P K R Z N W P I A Z B Z Y A B N L I R B A S A N Y B J U M
 Z N R O O F K P M Z Y V H J N O B B B K Z A S W I B R Y V J
 U A G M V R I Y J I A K F I Q W H D A I S F C T K Q D U N W
 U W U Q L D Z J C N N G A A T B A M C Z E K N H R S R R A A
 B S J D C K A V W T D G M L S C G M D U J B B F O N K C O Z
 Z I A T E S A T G S A V C C C W K M N W M J R I T H S E O N
 J Q H O G F W C G Y R E G Q T A S B V A B Y E T E I M B Y J

FIND THE WORDS OF THE VERSE BELOW IN THE PUZZLE ABOVE

"For this my son was dead and is alive again; he was lost and is found."

LUKE 15:24

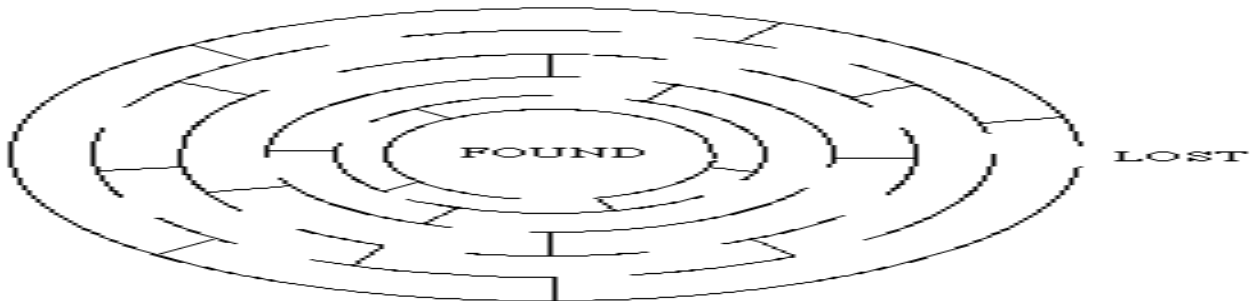

210. THE PRODIGAL SON

(LUKE 15:11-32)

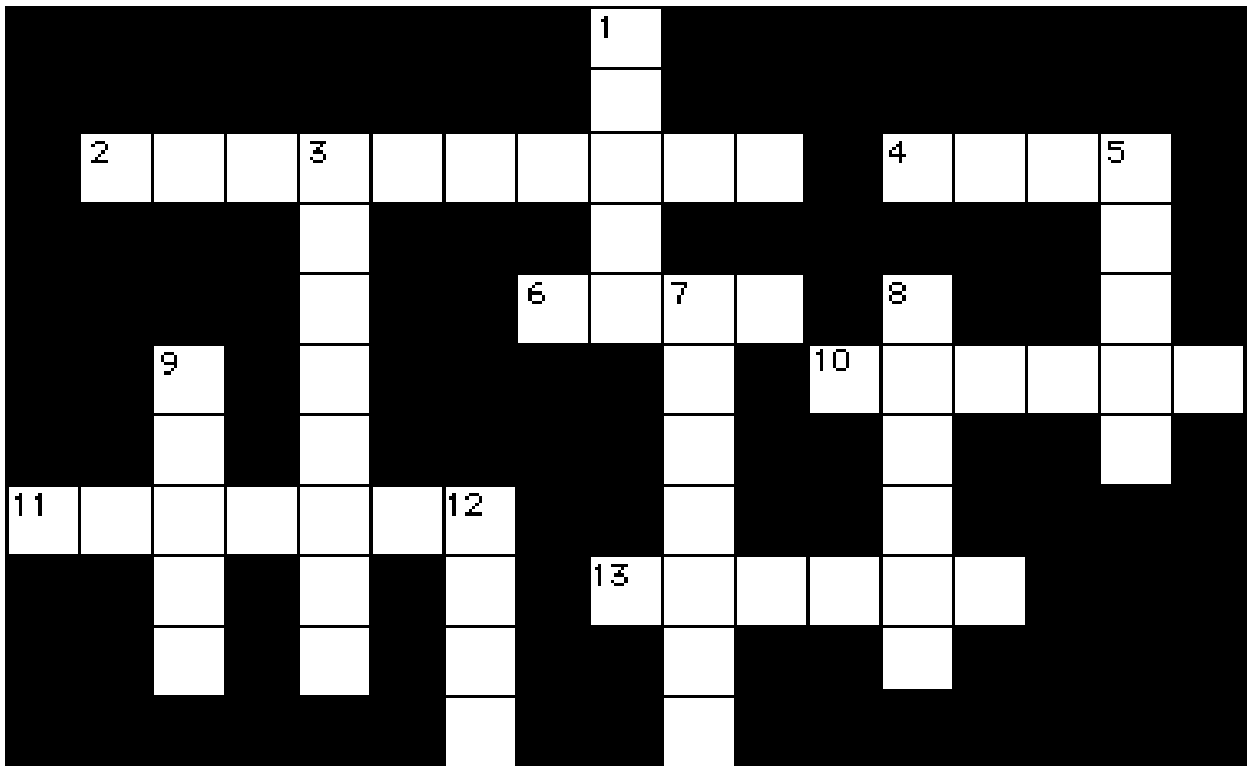

- 4 ACROSS "A certain man had two ____." **LUKE 15:11**
- 11 ACROSS The ____ son gathered all together and journeyed to a far country. **LUKE 15:13**
- 3 DOWN There he wasted his possessions with ____ living. **LUKE 15:13**
- 10 ACROSS "But when he had spent all, there arose a severe ____ in that land." **LUKE 15:14**
- 5 DOWN He was sent to the fields to feed _____. **LUKE 15:15**
- 13 ACROSS He said to himself, "I will arise and go to my _____." **LUKE 15:18**
- 2 ACROSS "When he was still a great way off, his father saw him and had _____." **LUKE 15:20**
- 6 ACROSS "The father said to his servants, 'Bring out the _____ robe and put it on him.'" **LUKE 15:22**
- 12 DOWN "Put a _____ on his hand." **LUKE 15:22**
- 7 DOWN "And _____ on his feet." **LUKE 15:22**
- 8 DOWN "Bring the _____ calf here and kill it, and let us eat and be merry." **LUKE 15:23**
- 1 DOWN "For this my son was dead and is _____ again." **LUKE 15:24**
- 9 DOWN "He was lost and is _____." **LUKE 15:24**

Bible Story 211

**THE
RICH MAN
AND LAZARUS**

LUKE 16:19-31

211. THE RICH MAN AND LAZARUS

(LUKE 16:19-31)



"There was a certain rich man, which was clothed in purple and fine linen, and fared sumptuously every day: And there was a certain beggar named Lazarus, which was laid at his gate, full of sores,"

LUKE 16:19-20

211. THE RICH MAN AND LAZARUS

(LUKE 16:19-31)

MEMORY VERSE:

"But he said to him, 'If they do not hear Moses and the prophets, neither will they be persuaded though one rise from the dead.' " LUKE 16:31

TRUE OR FALSE:

1. "There was a certain rich man who was clothed in purple and fine linen and fared sumptuously every day."
LUKE 16:19

TRUE OR FALSE

2. "But there was a certain beggar named Lazarus, full of sores, who was laid at his gate." LUKE 16:20
TRUE OR FALSE

CIRCLE THE CORRECT WORD:

3. "...desiring to be fed with the (**FEAST**, **CRUMBS**) which fell from the rich man's table. Moreover the dogs came and licked his sores." LUKE 16:21

TRUE OR FALSE:

4. "So it was that the beggar died, and was carried by the angels to Abraham's bosom. The rich man also died and was buried." LUKE 16:22

TRUE OR FALSE

"And being in torments in Hades..." LUKE 16:23

CIRCLE T FOR TRUE OR F FOR FALSE:

5. "...he lifted up his eyes and saw Abraham afar off..." (v23) T F

"...and Lazarus in his bosom" (v23) T F

"Then he cried out, 'Father Abraham, have mercy on me, and send Lazarus that he may dip the tip of his finger in the water and cool my tongue; for I am tormented in this flame.'" (v24) T F

But Abraham said, "Lazarus to do what the man asks." (v25) T F

"...between us and you there is a great gulf fixed..."(v26) T F

CIRCLE THE CORRECT WORDS:

6. "Then he said, 'I beg you therefore, father, that you would send him to my father's house, for I have five brothers, that he may (**TESTIFY**, **LISTEN**) to them, lest they also come to this place of torment.'" LUKE 16:27-28

7. "But he said to him, 'If they do not hear Moses and the prophets, neither will they be persuaded though one rise from the (**BED**, **DEAD**).'" LUKE 16:31

211. THE RICH MAN AND LAZARUS

(LUKE 16:19-31)

D C O M F O R T E D M B P Q H
 L E B E E B N A T S E Q T I I
 A W T G C D J N I G S E D A H
 Z N S N J D M L G R Z W D G Q
 A D E M E I P A O E K J P J K
 R F L S U M R B Y A J T S D L
 U A T R D D R Y M T Y B U W Z
 S W U I W O Y O B G M U T Y M
 R A D C S G K E T U S B Q H M
 E M J H R S W B R L B P L S N
 B S I O N A M C W F D D Y M E
 N L I K F I N E L I N E N K M
 P G U T R N Y R M A H A R B A
 V J G A V B E A S I N T I Y L
 W B Z S B F U G N M D V G O F

ABRAHAM
 BEGGAR
 COMFORTED
 CRUMBS
 DOGS
 FINE LINEN
 FLAME

GREAT GULF
 HADES
 LAZARUS
 MAN
 RICH
 TORMENTED

WHICH MAN WILL BE COMFORTED?

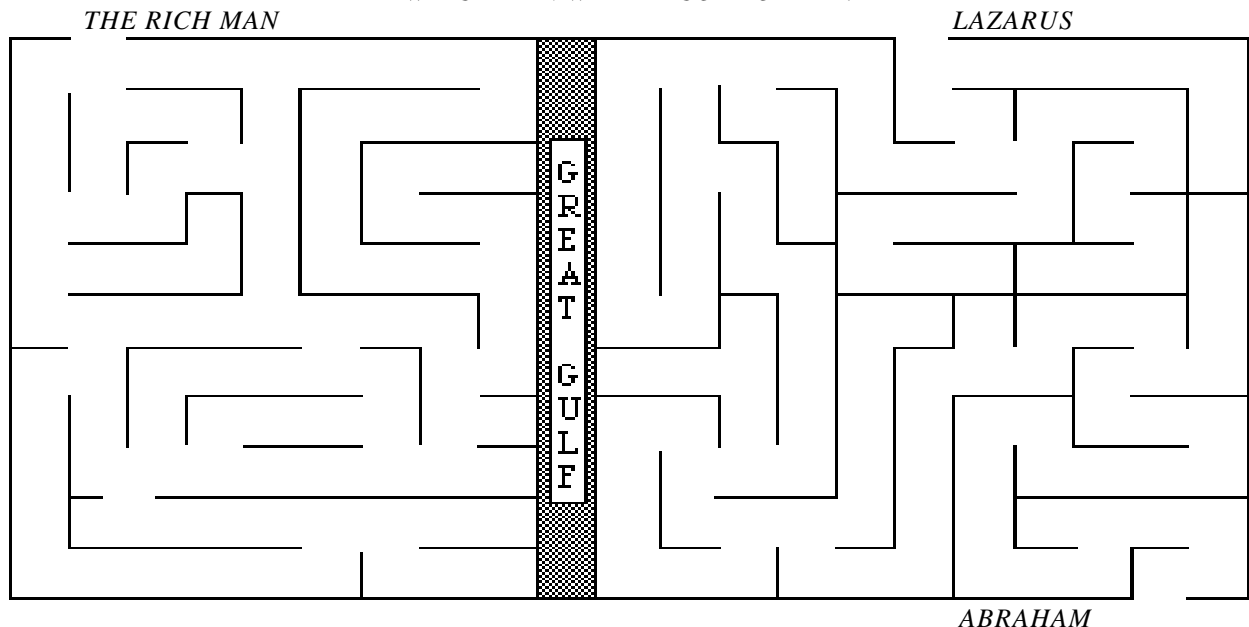

211. THE RICH MAN AND LAZARUS

(LUKE 16:19-31)

MEMORY VERSE:

"But he said to him, 'If they do not hear Moses and the prophets, neither will they be persuaded though one rise from the dead.' " LUKE 16:31

TRUE OR FALSE:

1. "There was a certain rich man who was clothed in purple and fine linen and fared sumptuously every day." LUKE 16:19

TRUE OR FALSE

2. "But there was a certain beggar named Lazarus, full of sores, who was laid at his gate." LUKE 16:20

TRUE OR FALSE

FILL IN THE BLANKS:

3. "...desiring to be fed with the _____ which fell from the rich man's table. Moreover the dogs came and licked his _____." LUKE 16:21

TRUE OR FALSE:

4. "So it was that the beggar died, and was carried by the angels to Abraham's bosom. The rich man also died and was buried." LUKE 16:22

TRUE OR FALSE

"And being in torments in Hades..." LUKE 16:23

CIRCLE T FOR TRUE OR F FOR FALSE:

5. "...he lifted up his eyes and saw Abraham afar off..." (v23) T F
- "...and Lazarus in his bosom" (v23) T F
- "Then he cried out, 'Father Abraham, have mercy on me, and send Lazarus that he may dip the tip of his finger in the water and cool my tongue; for I am tormented in this flame.' " (v24) T F
- But Abraham said, "Lazarus to do what the man asks." (v25) T F
- "...between us and you there is a great gulf fixed..."(v26) T F

FILL IN THE BLANKS:

6. "Then he said, 'I beg you therefore, father, that you would send him to my father's house, for I have five brothers, that he may _____ to them, lest they also come to this place of torment.'" LUKE 16:27-28
7. "But he said to him, 'If they do not hear Moses and the prophets, neither will they be persuaded though one rise from the _____.'" LUKE 16:31

211. THE RICH MAN AND LAZARUS

(LUKE 16:19-31)

B C J B I I S J Y J C D F W S R A K P N I Y M C B C T T P U
 C U S G O D G Z O H G L A U C Y B F U I Z G G D R I C H I B
 P Q Q Y P A D Z F G R S H D H Y V B Z J S T G Y T D E J R E
 O D I N H M E K V E G V A S U D Q M V J N I R R I N F I F A
 G C K M Z B P C B U N R H J E J D A F M C I H Q O Y Y P V F
 U N T H I T Z T S W G C Z H C I V N R Y A P U T W J R K Q I
 P W D L V Y C I V D Z M Y Q N P S S K T Z H V B E G G A R M
 M T Y D V L C O M W J L N O Q T M M K H B G A B A D N D X I
 N H H R F L U G T A E R G E L V C O Y G R C Y R E V L A I O
 R I A E B I Q T A Y P B J W K R Z A R F P J Y K B C M Y P Q
 B W U D Q O I A Z P N B T E D F L T G Y J N R E P A A S O H
 D P Q U E V W N S Z U A P B D E U M I Q P H T I M U B G R U
 C P S W Y S Z R H W O C L K O J T Z K T N E P E R A T M A N
 U W S J E Q K P M B F W J S K T M J U D Q E E J Q A L B V H
 G Q I N L Z K I B M L J C U Q O O S A C B D U E T U O F B P
 D T L S N U Q Q S W L U V H K U O R V M Q B S F F T N T R U
 T A D E T R O F M O C K T P L G E M M P F Y S S V E K L W Y
 A U S Z C A J D V U M O W E W F M B B E G K F A I K V A Y N
 S U J B V R B J O F S I H V B B B P B O N K J G F O E B B M
 T H F B Q N U Q J I Z T P A I D N C U E A T S Q R O F H G H
 O E F Z T M B M J B F E J R J B O D V A M J E F N P G P P B
 T R O B A G R R B G P J H L S K B T Z Y M M G D Y F S U F Y
 W J P H Q B B I E S G K Q W U K U B A U A V R H M D L V Q A
 F S E N F H K L A Y K K O J E A L B S U R A Z A L H C L K O
 A F I N E L I N E N B P A U A T P G U H O W A W Z D Y R G M
 M T O G H A E S W P U Z W O V W M E E A K Z S U U F D R B B
 F A O B P W F T L Y K Y V E D L C I F E C F F I I W T E Q H
 H Z C G J B J F Z B C Y M P Q A C K P C Y I N B B Y L V L N
 K S F R T P T A B D U O F T E P V B T N U Z T E N S V U J B
 N D K Q B E E Y P R M J S C N P Z P O A D T Q Y M K P V V V

- | | | |
|-----------|------------|-----------|
| ABRAHAM | FINE LINEN | MAN |
| BEGGAR | FLAME | REPENT |
| COMFORTED | GREAT GULF | RICH |
| CRUMBS | HADES | TORMENTED |
| DOGS | LAZARUS | |

WHICH MAN WILL BE COMFORTED?

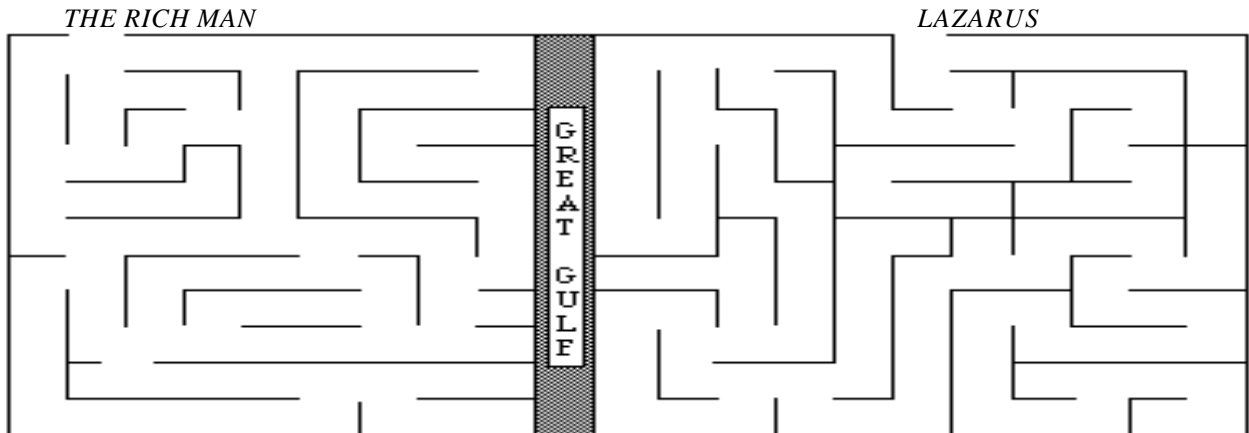

ABRAHAM

211. THE RICH MAN AND LAZARUS

(LUKE 16:19-31)

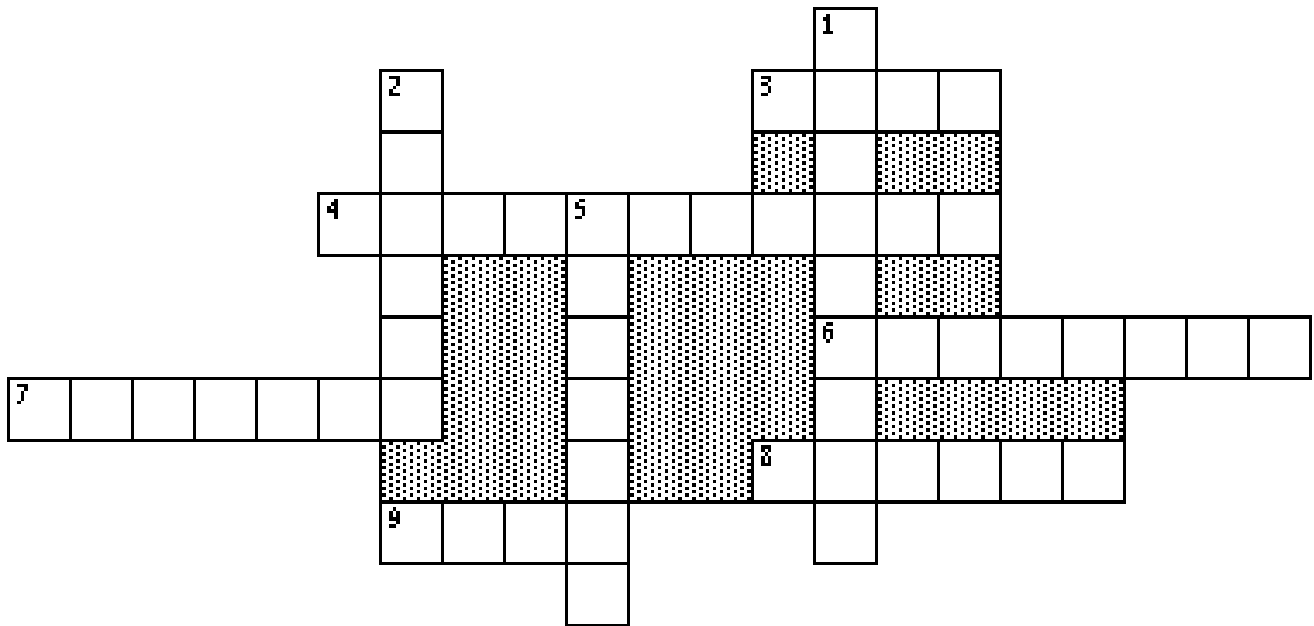

- 4 ACROSS "There was a certain rich man who was clothed in purple and fine linen and fared _____ every day." **LUKE 16:19**
- 8 ACROSS "But there was a certain _____ named Lazarus, full of sores, who was laid at his gate." **LUKE 16:20**
- 2 DOWN "...desiring to be fed with the _____ which fell from the rich man's table. Moreover the dogs came and licked his sores." **LUKE 16:21**
- 6 ACROSS "So it was that the beggar died, and was carried by the angels to _____ bosom. The rich man also died and was buried." **LUKE 16:22**
- 7 ACROSS "...he lifted up his eyes and saw Abraham afar off and _____ in his bosom." **LUKE 16:23**
- 3 ACROSS "Then he cried out, 'Father Abraham, have mercy on me, and _____ Lazarus that he may dip the tip of his finger in the water and cool my tongue; for I am tormented in this flame.'" **LUKE 16:24**
- 9 ACROSS "...between us and you there is a great _____ fixed..." **LUKE 16:26**
- 5 DOWN "Then he said, 'I beg you therefore, father, that you would send him to my father's house, for I have five brothers, that he may _____ to them, lest they also come to this place of torment.'" **LUKE 16:27-28**
- 1 DOWN "But he said to him, 'If they do not hear Moses and the prophets, neither will they be _____ though one rise from the dead.'" **LUKE 16:31**

Bible Story 212

JESUS HEALS TEN LEPERS

LUKE 17:11-19



"One of the ten lepers, when he saw that he was healed, returned , and with a loud voice glorified God." *Luke 17:15*

212. JESUS HEALS TEN LEPERS

(LUKE 17:11-19)

MEMORY VERSE:

"Oh, give thanks to the LORD, for He is good! For His mercy endures forever."
PSALM 107:1

TRUE OR FALSE:

1. "Then as He entered a certain village, there met Him ten men who were lepers, who stood afar off." **LUKE 17:12**

TRUE OR FALSE

CIRCLE THE CORRECT WORDS:

2. "And they lifted up their voices and said, 'Jesus, Master, have (**MERCY**, **MUSIC**) on us!' "**LUKE 17:13**
3. "So when He saw them, He said to them, 'Go, show yourselves to the priests.' And so it was that as they went, they were (**KILLED**, **CLEANSED**)." **LUKE 17:14**

UNDERLINE THE CORRECT ANSWER:

4. "Now one of them, when he saw that he was healed..." **LUKE 17:15-16**
 - a. returned
 - b. and with a loud voice glorified God
 - c. fell down on his face at His feet
 - d. giving Him thanks
 - e. all of the above

TRUE OR FALSE:

5. "...And he was a Samaritan." **LUKE 17:16**

TRUE OR FALSE

UNDERLINE THE CORRECT ANSWER:

6. "So Jesus answered and said,..." **LUKE 17:17-18**
 - a. "Were there not ten cleansed?"
 - b. '...But where are the nine?'
 - c. "Were there not any found who returned to give glory to God except this foreigner?"
 - d. all of the above

TRUE OR FALSE:

7. "And He said to him, 'Arise, go your way. Your faith has made you well.'" **LUKE 17:19**

TRUE OR FALSE

212. JESUS HEALS TEN LEPERS

(LUKE 17:11-19)

U Y C R E M Q A U P I K J R F
Q F N J N I T M A L W E Z P A
S O M N G V A B N D E F Z I Y
S P H S B V Q T S E E P K Q Y
I E A I R A M A S U Z L E D O
L O T Z G B F Y M S S J A R F
F O L E R Q H C G G B E C E S
A C D K N Y P L L D K T J J H
I D E N R U T E R E Q S T Q V
T F R B Q E J I F E A K I R B
H K E Z I E T O H P J N O I S
S B B F P L N V A Z B A S L V
G A L I L E E I W C B H T E M
J Y W H H N B Q N C R T A S D
F E N O Z V I Z B Q B E N T A

CLEANSED
FAITH
GALILEE
HEALED
JESUS

LEPERS
MERCY
NINE
ONE

RETURNED
SAMARIA
TEN
THANKS

LEPER

HELP THE HEALED LEPER TO FIND HIS WAY BACK TO JESUS

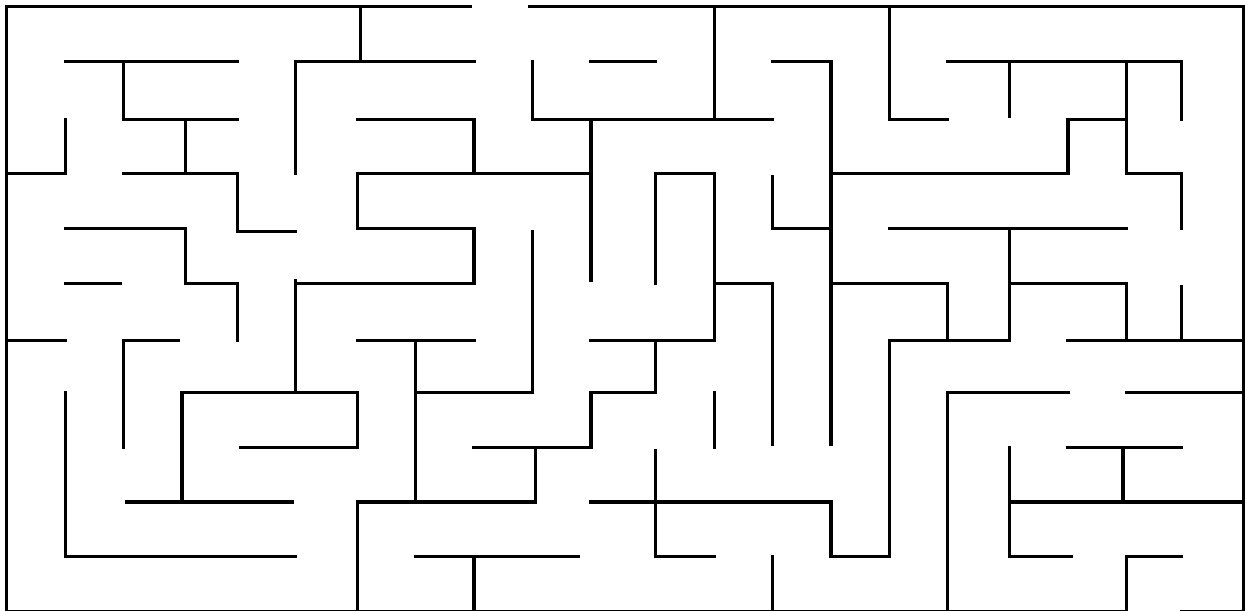

JESUS

212. JESUS HEALS TEN LEPERS

(LUKE 17:11-19)

MEMORY VERSE:

"Oh, give thanks to the LORD, for He is good! For His mercy endures forever."
PSALM 107:1

TRUE OR FALSE:

1. "Then as He entered a certain village, there met Him ten men who were lepers, who stood afar off." **LUKE 17:12**

TRUE OR FALSE

FILL IN THE BLANKS:

2. "And they lifted up their voices and said, 'Jesus, Master, have _____ on us!' " **LUKE 17:13**
3. "So when He saw them, He said to them, 'Go, show yourselves to the priests.' And so it was that as they went, they were _____." **LUKE 17:14**

UNDERLINE THE CORRECT ANSWER:

4. "Now one of them, when he saw that he was healed..." **LUKE 17:15-16**
- a. returned
 - b. and with a loud voice glorified God
 - c. fell down on his face at His feet
 - d. giving Him thanks
 - e. all of the above

TRUE OR FALSE:

5. "...And he was a Samaritan." **LUKE 17:16**

TRUE OR FALSE

UNDERLINE THE CORRECT ANSWER:

6. "So Jesus answered and said,..." **LUKE 17:17-18**
- a. "Were there not ten cleansed?"
 - b. '...But where are the nine?'
 - c. "Were there not any found who returned to give glory to God except this foreigner?"
 - d. all of the above

FILL IN THE BLANK:

7. "And He said to him, 'Arise, go your way. Your _____ has made you well.'" **LUKE 17:19**

212. JESUS HEALS TEN LEPERS

(LUKE 17:11-19)

E B B V P Q U T W K O L S P U P U W B R P A R D R S U L I U
 D Y B D B B U H S R A U E S M L G K T U M O U D S M B M B N
 P K O D Q I T T T S E K W J O F J C M P K L Y M R M K W P R E
 U P H Z J T T T I D G Q M G A L I L E E C E E M C I V B Q S
 G U S Z I A S R A O E N G T O B M Z Z B S A S J U R K E I B
 I Y S O C L D A D N U L O W E J E B F I G E Z L R K G C J T
 C F R W T B D R M C N I A I P H R I V F E Q P P S Q P H L I
 E K V H C Z Q W G A U S V E K T C Z F W Y U J O J Y H M J L
 U T N Q J Z C P W V R V S H H J Y F H L U S R E P E L B V E
 X G G I W N U N A C D I P J J Y V Z N J W T H L L C K I R I
 M E D L Y K J K F C L U T D F R U B E B R V D T P Z H V R A
 K Y P H J O K B U H U U T A Y D B D E B E S C A B A C M K K
 U G K T T B S C T R F A Y U N C N K M K T E U I N K O T J Q
 Y M S Y N H M D O E L D W R T G H B J J U T U R S R V Q S Y
 Y Q P O A F J W M M Y D B O O S B U Q K R K S A L V N V F R
 R H P A S V T K J Q H W H L W L A Y V U N N Y M P Z J U Q B
 F V T V L I A I C N B T J O U Q G E E M E B J A H Y L G V T
 H V R E P O A E K L O L Y U G U U E V B D Y G S L E D B B P
 E G B C N N U P G Y E A K I H M V J V Y I Z A P Q H R D R K
 L S O A U H E I H M I A P I B J A A L R A A K N U Z Z O B Z
 M N S L T I N Y G A R O N E N O E V A S C B R R I C X N I O
 G B L O N U Q B D S F A B S V Q I K I U L U B A C S Y Z U V
 M K K Z D A B B V V Y P K B E L S U L S P E N P C G A F Q L
 B K W M R F N P B Y B A G R S D G O R E A D Y L M I E N H C
 P O V F A F A P G K D D T W U J J Z U J H K N Y R F M B C Y
 M J J M Z T Y Y E W F Y H G B T P W U T I G M M B L B A C Y
 W Q B Q E Q Q N C L B S A T H W Z A I T E C Q T G B Z D N P
 N S W S M H I F Z W E M N K U B F A C T Y M P F B K U P U D
 G P E Q D N U O H W H U K W Q M F M Q C A N L H I M I U K D
 K M L V W A Q J K Z T B S I T L B Z N M Q Q J D V I J K S A

CLEANSSED
 FAITH
 GALILEE
 GLORY
 GOD
 HEALED

JESUS
 LEPERS
 MERCY
 NINE
 ONE

RETURNED
 SAMARIA
 SAMARITAN
 TEN
 THANKS

START

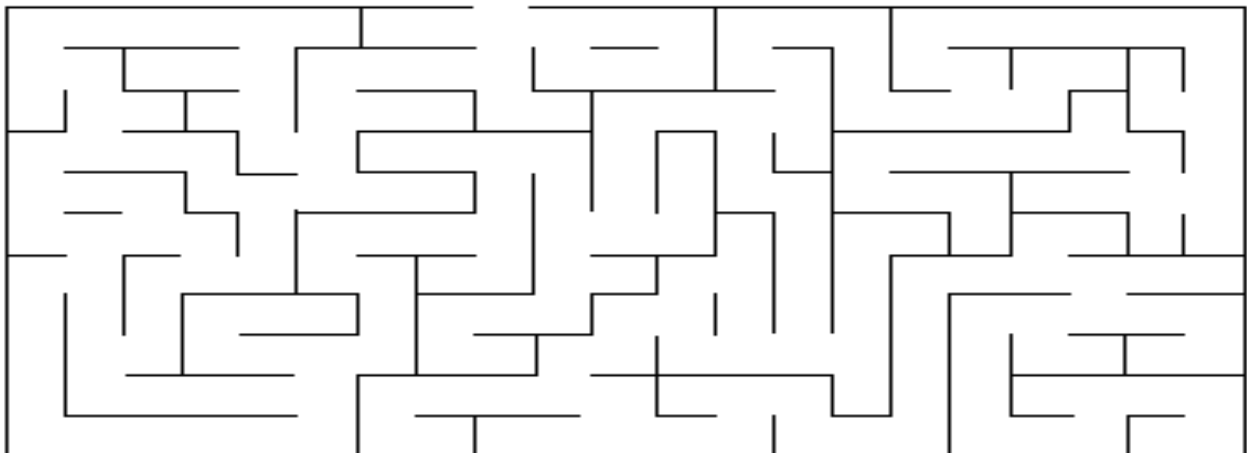

FINISH

212. JESUS HEALS TEN LEPERS

(LUKE 17:11-19)

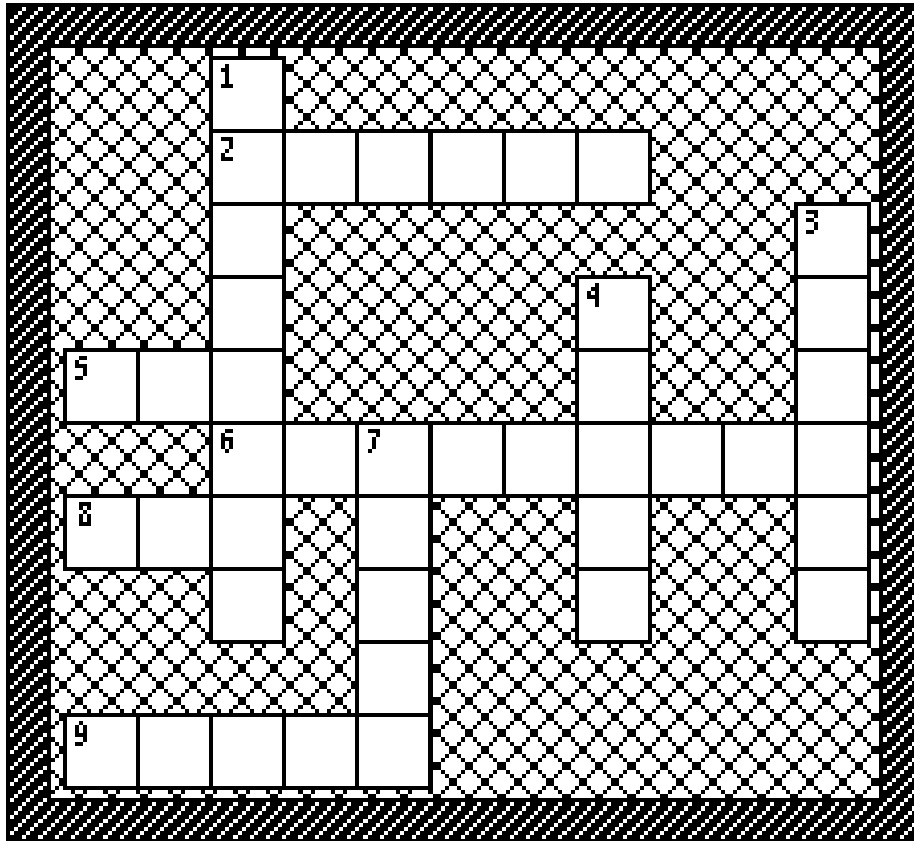

- 3 DOWN "Oh, give _____ to the LORD, for He is good! For His mercy endures forever." **PSALM 107:1**
- 2 ACROSS "Then as He entered a certain village, there met Him ten men who were _____, who stood afar off." **LUKE 17:12**
- 7 DOWN "And they lifted up their voices and said, 'Jesus, Master, have _____ on us!' " **LUKE 17:13**
- 1 DOWN "So when He saw them, He said to them, 'Go, show yourselves to the priests.' And so it was that as they went, they were _____." **LUKE 17:14**
- 8 ACROSS "Now _____ of them, when he saw that he was healed, returned, and with a loud voice glorified God, and fell down on his face at His feet, giving Him thanks." **LUKE 17:15-16**
- 6 ACROSS "...And he was a _____." **LUKE 17:16**
- 5 ACROSS "So Jesus answered and said, 'Were there not _____ cleansed? But where are the nine?' " **LUKE 17:17**
- 9 ACROSS "Were there not any found who returned to give _____ to God except this foreigner?" **LUKE 17:18**
- 4 DOWN "And He said to him, 'Arise, go your way. Your _____ has made you well.' " **LUKE 17:19**

Bible Story 213

**THE PHARISEE
&
THE PUBLICAN**

LUKE 18:9-14



"Jesus spoke a parable about a Pharisee and a tax collector."
Luke 18:9-14

213. THE PHARISEE AND THE PUBLICAN

(LUKE 18:9-14)

MEMORY VERSE:

"...for everyone who exalts himself will be abased, and he who humbles himself will be exalted." LUKE 18:14

TRUE OR FALSE:

1. "Also He spoke this parable to some who trusted in themselves that they were righteous, and despised others." **LUKE 18:9**
TRUE OR FALSE

CIRCLE THE CORRECT WORD:

2. "Two men went up to the (MOUNTAIN, TEMPLE) to pray..." **LUKE 18:10**

TRUE OR FALSE:

3. "...one a Pharisee and the other a tax collector." **LUKE 18:10**
TRUE OR FALSE

CIRCLE THE CORRECT WORD:

4. "The Pharisee stood and prayed thus with (GOD, HIMSELF), 'God, I thank You that I am not like other men...'" **LUKE 18:11**

TRUE OR FALSE:

5. "And the tax collector, standing afar off, would not so much as raise his eyes to heaven, but beat his breast, saying, 'God be merciful to me a sinner!'" **LUKE 18:13**
TRUE OR FALSE

6. "I tell you, this man went down to his house justified rather than the other..." **LUKE 18:14**
TRUE OR FALSE

CIRCLE THE CORRECT WORD:

7. "...for everyone who exalts himself will be abased, and he who (GRUMBLES, HUMBLE) himself will be exalted." **LUKE 18:14**

213. THE PHARISEE AND THE PUBLICAN

(LUKE 18:9-14)

A M V E U Z G C E Y L Z K Q I
D N O B G C W I L L P S S S P
Y E D H F L P N M R V T Y S K
I T U B W F L E S M I H H O R
B L E D E A B A S E D V U E E
L M D V Y N C P H E G G M Z E
O E E N I W O C Y B Y W B H N
B Z T P F C V Y Y V Q D L P A
U E L Y B W U B R T D K E E I
P I A G H A I C M E O A S U P
W I B O S T L A B E V G B V Q
C D E N L Z P B B O O E F F W
P Z D W F L E S M I H S L I I
R P W Y A S N P P J K A K U L
F Z E Z E D S R R Q P U I H L

FIND THE WORDS OF THE VERSE BELOW IN THE PUZZLE ABOVE

"Everyone who exalts himself will be abased, and he who humbles himself will be exalted." LUKE 18:14

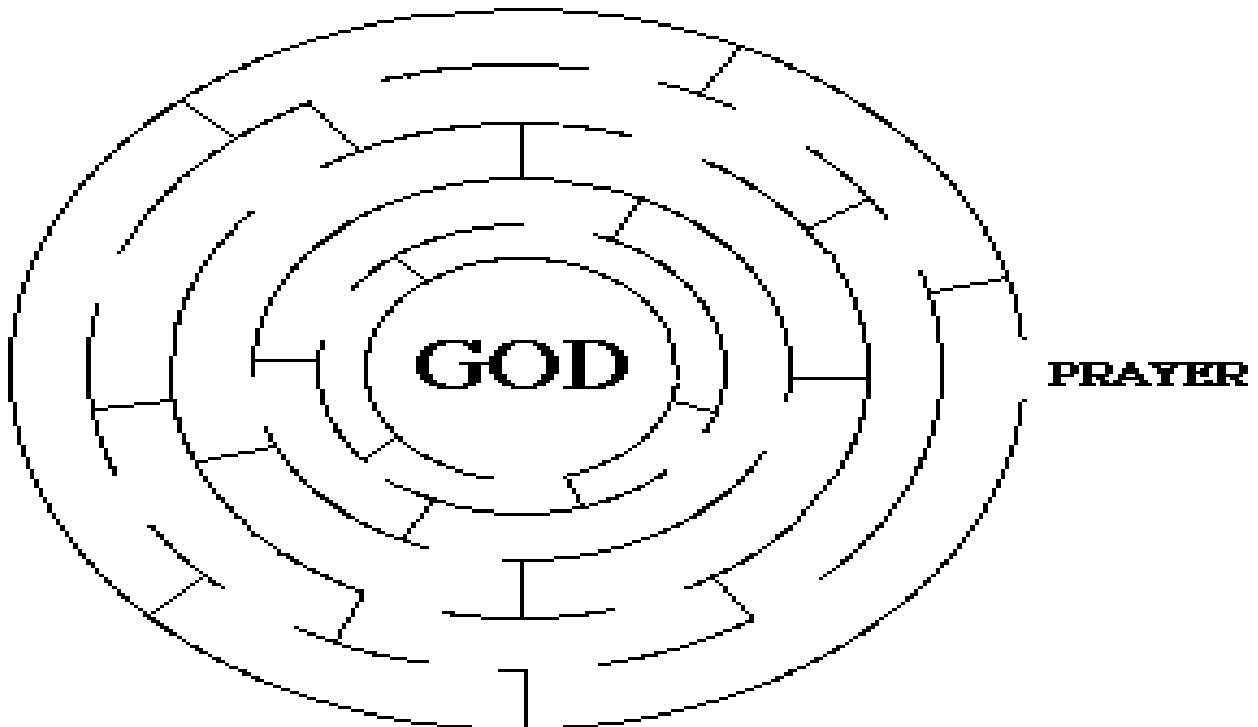

213. The Pharisee and the Publican

(Luke 18:9-14)

MEMORY VERSE:

"...for everyone who exalts himself will be abased, and he who humbles himself will be exalted." LUKE 18:14

TRUE OR FALSE:

1. "Also He spoke this parable to some who trusted in themselves that they were righteous, and despised others." LUKE 18:9
TRUE OR FALSE

FILL IN THE BLANK:

2. "Two men went up to the _____ to pray..." LUKE 18:10

TRUE OR FALSE:

3. "...one a Pharisee and the other a tax collector." LUKE 18:10
TRUE OR FALSE

FILL IN THE BLANK:

4. "The Pharisee stood and prayed thus with _____, 'God, I thank You that I am not like other men...'" LUKE 18:11

TRUE OR FALSE:

5. "And the tax collector, standing afar off, would not so much as raise his eyes to heaven, but beat his breast, saying, 'God be merciful to me a sinner!'" LUKE 18:13
TRUE OR FALSE
6. "I tell you, this man went down to his house justified rather than the other..." LUKE 18:14
TRUE OR FALSE

FILL IN THE BLANK:

7. "...for everyone who exalts himself will be abased, and he who _____ himself will be exalted." LUKE 18:14

213. THE PHARISEE AND THE PUBLICAN

(LUKE 18:9-14)

E N D V Y B Q A V Z Y D B C R T Z H Z W R A T Q T I T S Q R
 B Z V G K U B K Q S B F H U K P P V I T A B N B L O B I U B
 S C U J Y L Z I D V O H C V Z M E E J D F F B U R B H L S V
 W U B T T N P Y D M J L O N L S B L Z C W L U W F E Q N O S
 Q Z S F P Z Q T D O C D Y V B D L C T V V I Q D F O A D K D
 O H S G S H L F V N V I K M I Q I J T S B H D Y Z N E G S R
 R Z O J J R A Z F G G P E U V H A I I U Q V Y N R R D W J F
 G M V W V A L B L I W E O O V E I T J L L I W K F L B E F N
 C U Z J D A L C E C H M N B T N R B I K J M C P M B B O H W
 I D D H T J M S S N H W J O L P O H J Y C E Z H C A I Z R V
 G D C G T Y S L M E B L S M Y T E I E F A Y Y Q L D Z A C V
 U V B B Q G O S I B B G Z G C R N U B B S Y S T R V F K R B
 K V O A F H A N H P B S N Q M L E K B D B S S O I Z A Z L W
 N L P B N S L P V U U Z W O G Z T V R Q W Q V Z P R K E S J
 R C O H F E K M D U L R L T K T V B E N D K B F Z K Q A P B
 F L R P T Q N N K R Y L I H M T B B B N I Y T L V E S H E E
 J V J T H M M Q B J I O O K P B A F Q F A J G E Q G W V F D
 L N Y Q D B G Q S W L J V W E S K B K Y J P B Q Q I Y L Z C
 F M M B T B G H H Z H L M W I M C A A V T A H P U V U V L V
 Z J G O N C T V P F B L G B P H E Y L S L V Q S S M F R V H
 V C U N Y B E Z P J K A D L L V U B E S E L B M U H I E O H
 K M U C B B L U R F K G O R E Y Z C S Y N D Z B D V E R L A
 C Y O B P W S D B E B H T Q P B B M Z B J T T U E O O T Z H
 D S V B F Y H F N O D G D C K L E U R F O P W D B V Z Q J B
 Q O V I L U V O G R O N E R S M Q A L P I G V Z B O E S P E
 L J R F E W P H B I F W T H N R A K U N M B B O U A N D E U
 O I F A S D Z G L Y B B L N U E O I C I U B W B Q F R W N D
 J M W W M O S U L S Q W A N W J L F R D Z B M U J B I S R J
 W O P B I K M Q N Y R B B V S L B L K L D O V O A J Y J B T
 Z Y W B H J B J B D K V E G C D F O G G C C Z B D Y M R I Q

FIND THE WORDS IN THE VERSE BELOW IN THE PUZZLE ABOVE

"For everyone who exalts himself will be abased, and he who humbles himself will be exalted." LUKE 18:14

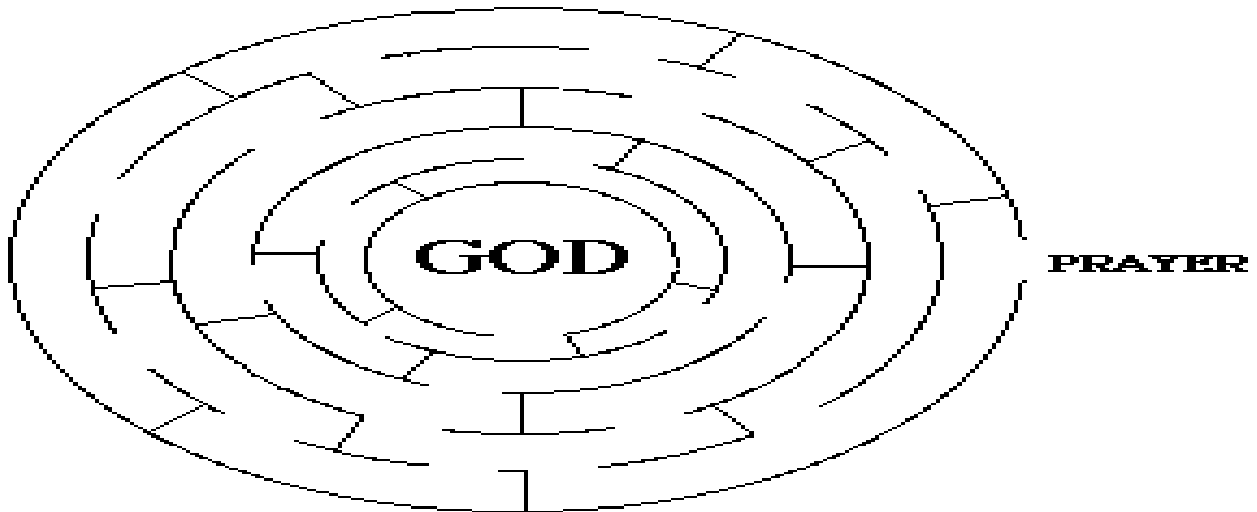

213. THE PHARISEE AND THE PUBLICAN

(LUKE 18:9-14)

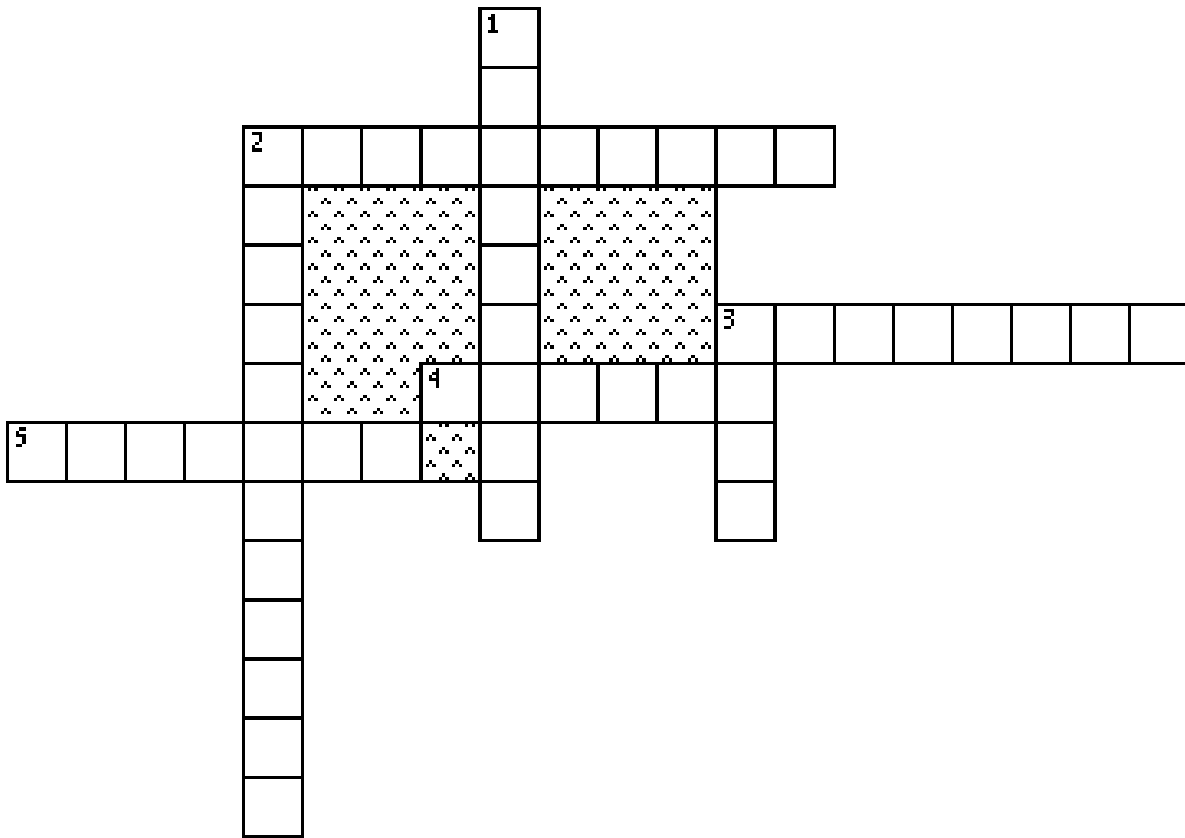

- 2 ACROSS "Also He spoke this parable to some who trusted in _____ that they were righteous, and despised others." **LUKE 18:9**
- 3 DOWN "Two men went up to the temple to _____." **LUKE 18:10**
- 2 DOWN "...one a Pharisee and the other a _____." **LUKE 18:10**
- 3 ACROSS "The _____ stood and prayed thus with himself, 'God, I thank You that I am not like other men...'" **LUKE 18:11**
- 4 ACROSS "And the tax collector, standing afar off, would not so much as raise his eyes to heaven, but beat his breast, saying, 'God be merciful to me a _____!'" **LUKE 18:13**
- 1 DOWN "I tell you, this man went down to his house _____ rather than the other..." **LUKE 18:14**
- 5 ACROSS "...for everyone who exalts himself will be abased, and he who _____ himself will be exalted." **LUKE 18:14**

Bible Story 214

THE RICH YOUNG RULER

LUKE 18:18-27

214. THE RICH YOUNG RULER (LUKE 18:18-27)

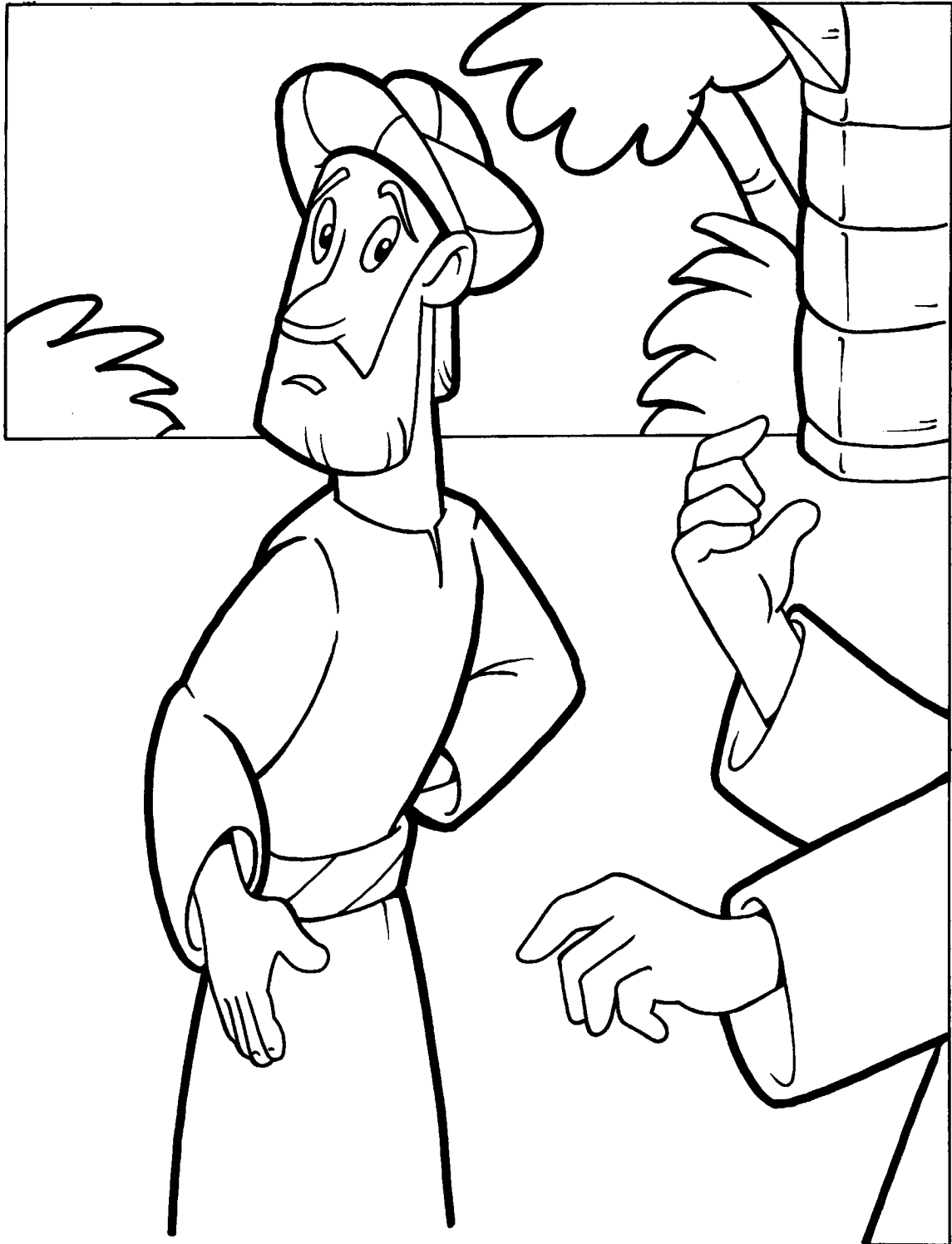

"Now when Jesus heard these things, he said unto him, Yet lackest thou one thing: sell all that thou hast, and distribute unto the poor, and thou shalt have treasure in heaven: and come, follow me. And when he heard this, he was very sorrowful: for he was very rich."

LUKE 18:22-23

214. THE RICH YOUNG RULER

(LUKE 18:18-27)

MEMORY VERSE:

"The things which are impossible with men are possible with God." LUKE 18:27

CIRCLE THE CORRECT WORDS:

1. "Now a certain ruler asked Him, saying, "(HEY, GOOD) Teacher, what shall I do to inherit eternal life?" " **LUKE 18:18**
2. "So Jesus said to him, 'Why do you call Me good? No one is good but One, that is (GOD, MAN).' " **LUKE 18:19**

TRUE OR FALSE: CIRCLE T FOR TRUE OR F FOR FALSE

"You know the commandments:..." **LUKE 18:20**

- | | | |
|--------------------------------------|---|---|
| 3. 'Do not commit adultery' | T | F |
| 'Do steal' | T | F |
| 'Do not bear false witness' | T | F |
| 'Honor your father and your mother.' | T | F |

CIRCLE THE CORRECT WORD(S):

4. "And he said, '(SOME OF, ALL) these I have kept from my youth.' " **LUKE 18:21**

TRUE OR FALSE:

5. "So when Jesus heard these things, He said to him, 'You still lack one thing.' " **LUKE 18:22**
TRUE OR FALSE
6. "And those who heard it said, 'Who then can be saved?' " **LUKE 18:26**
TRUE OR FALSE

CIRCLE THE CORRECT WORD:

7. "But He said, 'The things which are impossible with men are(POSSIBLE, IMPOSSIBLE) with God.' " **LUKE 18:27**

214. THE RICH YOUNG RULER (LUKE 18:18-27)

V F S T N E M D N A M M O C B
 T N I C Q F Y Q E Y M Q E V N
 C M M W T K T V D R D Y K E Y
 V F J G B G G Y K B E N G A G
 S F E G B T R E A S U R E B O
 H O F V K A R E E H I I C Y O
 D L I B S Z R L E M R G B Z D
 L L L I I I D A O I G J B R Q
 H O L F S E V D J D B L V Q Q
 Z W A B E E G Z Y A F D B V F
 E I N N N N K P T E A C H E R
 S E R L I N U A C A M E L E E
 Q V E K B T I R E H N I G Y Z
 U M T Y W T P U R U L E R B H
 Z N E E J S S Y Z T P E K P F

CAMEL
 COMMANDMENTS
 ETERNAL LIFE
 FOLLOW
 GOOD

HEAVEN
 INHERIT
 KEPT
 KINGDOM

NEEDLE'S EYE
 RULER
 TEACHER
 TREASURE

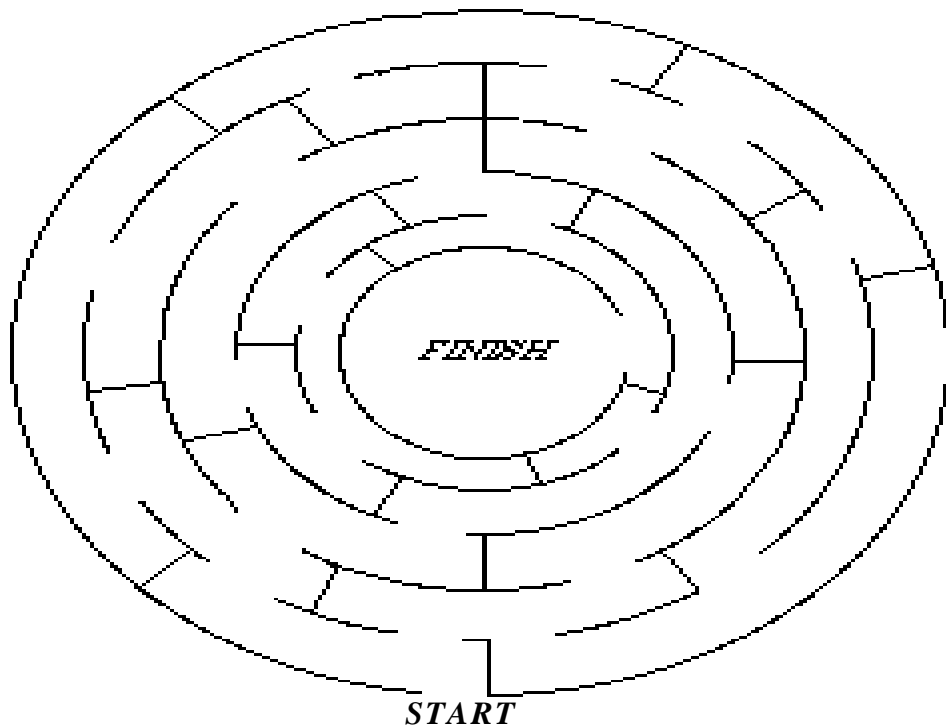

214. THE RICH YOUNG RULER

(LUKE 18:18-27)

MEMORY VERSE:

"The things which are impossible with men are possible with God." LUKE 18:27

FILL IN THE BLANKS:

1. "Now a certain ruler asked Him, saying, " _____ Teacher, what shall I do to inherit eternal life?" " **LUKE 18:18**
2. "So Jesus said to him, 'Why do you call Me good? No one is good but One, that is _____.'" **LUKE 18:19**

TRUE OR FALSE: CIRCLE T FOR TRUE OR F FOR FALSE

"You know the commandments:..." **LUKE 18:20**

- | | | |
|--------------------------------------|---|---|
| 3. 'Do not commit adultery' | T | F |
| 'Do steal' | T | F |
| 'Do not bear false witness' | T | F |
| 'Honor your father and your mother.' | T | F |

FILL IN THE BLANK:

4. "And he said, ' _____ these I have kept from my youth.'" **LUKE 18:21**

TRUE OR FALSE:

5. "So when Jesus heard these things, He said to him, 'You still lack one thing.'" **LUKE 18:22**

TRUE OR FALSE

6. "And those who heard it said, 'Who then can be saved?'" **LUKE 18:26**

TRUE OR FALSE

FILL IN THE BLANK:

7. "But He said, 'The things which are impossible with men are _____ with God.'" **LUKE 18:27**

214. THE RICH YOUNG RULER (LUKE 18:18-27)

B Z O I B Q R A Q B B M O P J T N Q F N B J P M P V S L M B
 T M B L P K L L I B R Q B B T B M B J S Z F M S T B Z E S A
 I M Z Q D K P L J P N F I K G U U O S T H J P L G Z S U G Q
 T H Z S J V J V G S S U B S P C G G J N P Q S W S O U R J H
 L W V Z P H Z C P G O N B U M G S B E E Y L S G P A D U N C
 K V B G D S Z B C D A R A I R B Q T F M J L R F B R C W U G
 W V O I Q T U B Q T G Q R I Y A P Y H D U B N U K Y Q G O I
 Q N A K A O P B I M U G S O L K H U F N G R Z M L B Q N F I
 I C O W F L F F Y P W T M Y W E B O B A P Y Y L K E H H O J
 E K H K I N G D O M O C U U E F L K M M C M M C V V R E L P
 Q N B B A S Q E R U W A Z W H L B I H M M Q R B M R B H V B
 G Z W N H T N H T R T B O Y O N T L T O K U Y P T L S P C Z
 A Y B K D T B O O E H N B W R Y I G D C J U F F P N B Q P F
 D I K C W R E C I P R B H F I I R R L B P M Q T Z Q F F F U
 B W Y H Y B Q A T T Z N W Y V Y E E T P F R D V K M O M T N
 D Z N P F Z C G C Y N I A O K Q H Y Q T G I W R R V Z G I Q
 L L B U Z U J S E H M B C L T S N K E D E V A S O S F G D D
 V M J M W O Y M H W E G E S L W I Y F G R C M K Y C O D L C
 G O J J G W C E I Y B R R U R I E C R C N B G S D L G C C U
 L B G B Z E T Z B D O A Z B A S F D D U C Q R J U S T R L A
 J D J O T C S E H C I R B U E U B E H A D J L D P D C D K E
 C R V J T U G B O S M H P L L K Q O K Q S U R D F M A E A I
 T C N R J C U O E T C Q D G J T T B P O O V Y D L V M S D H
 U B H O G J D B J T A E M O K P Y F P A M R M W S C E S P T
 N R E Z A O B V L W E Q B N S E O K P B L F P C W B L B R J
 Y N A G O T B D B N C Y U N V N E Q R B W J N N B M V R H B
 T V T G Z H T H N N B C F T H O B U B R R S S S F J A J Q K
 F N E E T H G Q Z G B L S D W G Q S J J J A I P B W M F B K
 U O H C U L B B Z F N V U H S K P R L A W O S C B W A H N P
 Y L D J J Z G K Q O I B Y Y G D W T Q H H I J K O O H P N E

CAMEL
 COMMANDMENTS
 ETERNAL LIFE
 FOLLOW
 GOOD

INHERIT
 KINGDOM
 NEEDLE'S EYE
 RICHES

RULER
 SAVED
 SORROWFUL
 TEACHER

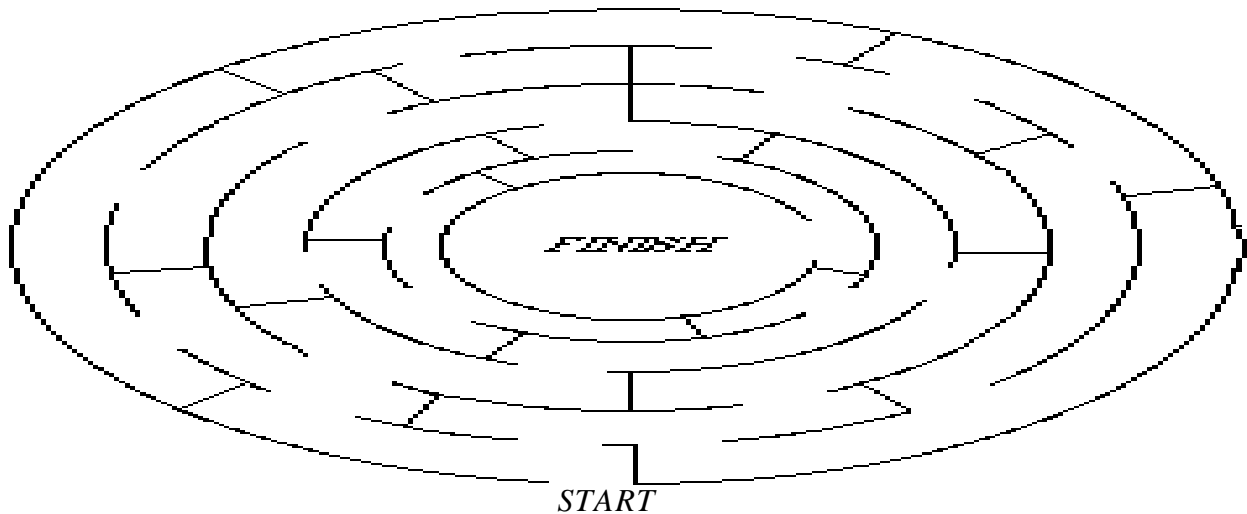

214. THE RICH YOUNG RULER

(LUKE 18:18-27)

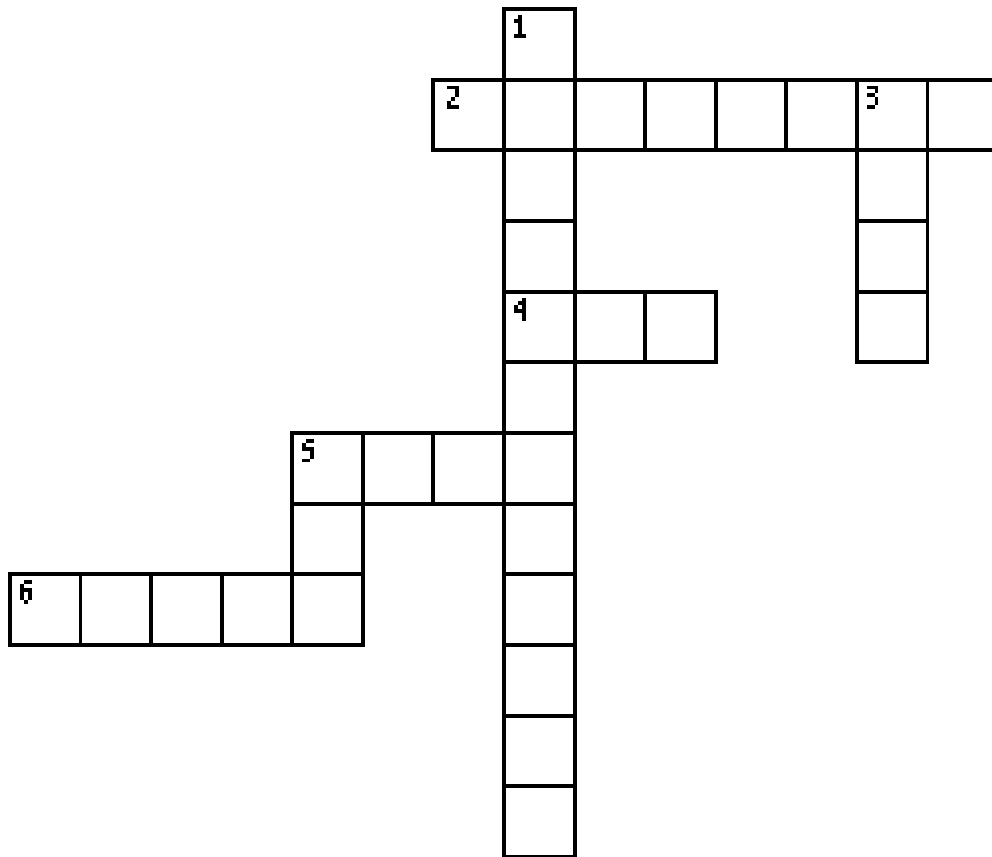

- 5 ACROSS "Now a certain ruler asked Him, saying, " _____ Teacher, what shall I do to inherit eternal life?" " **LUKE 18:18**
- 5 DOWN "So Jesus said to him, 'Why do you call Me good? No one is good but One, that is _____.'" **LUKE 18:19**
- 1 DOWN "You know the _____:..." **LUKE 18:20**
- 4 ACROSS "And he said, ' _____ these I have kept from my youth.'" **LUKE 18:21**
- 3 DOWN "So when Jesus heard these things, He said to him, 'You still _____ one thing.'" **LUKE 18:22**
- 6 ACROSS "And those who heard it said, 'Who then can be _____'" **LUKE 18:26**
- 2 ACROSS "But He said, 'The things which are impossible with men are _____ with God.'" **LUKE 18:27**

Bible Story 215

**PARABLE
OF
THE WORKERS IN
THE VINEYARD**

Matthew 20:1-16

215. PARABLE OF THE WORKERS IN THE VINEYARD (MATTHEW 20:1-16)



"And when they came that *were hired* about the eleventh hour, they received every man a penny. But when the first came, they supposed that they should have received more; and they likewise received every man a penny."

MATTHEW 20:9-10

215. PARABLE OF THE WORKERS IN THE VINEYARD

(MATTHEW 20:1-16)

MEMORY VERSE:

"So the last will be first, and the first last. For many are called, but few chosen."

MATTHEW 20:16

"For the kingdom of heaven is like a landowner who went out early in the morning to hire laborers for his vineyard." MATTHEW 20:1

TRUE OR FALSE:

1. "Now when he had agreed with the laborers for a denarius a day, he sent them into his vineyard."

MATTHEW 20:2

TRUE OR FALSE

CIRCLE THE CORRECT WORDS:

2. "And he went out about the third hour and saw others standing (**BUSY, IDLE**) in the marketplace." MATTHEW 20:3

3. "...and said to them, 'You also go into the vineyard, and whatever is (**RIGHT, WRONG**) I will give you.'..." MATTHEW 20:4

UNDERLINE THE CORRECT ANSWER:

4. "Again he went out about the..."
- a. sixth hour MATTHEW 20:5
 - b. ninth hour MATTHEW 20:5
 - c. eleventh hour MATTHEW 20:6
 - d. all of the above

TRUE OR FALSE:

5. "So when evening had come, the owner of the vineyard said to his steward, 'Call the laborers and give them their wages, beginning with the last to the first.'" MATTHEW 20:8

TRUE OR FALSE

CIRCLE THE CORRECT WORDS:

6. "And when those came who were hired about the eleventh hour, they each received a (**DENARIUS, DIME**)."

MATTHEW 20:9

7. "But when the first came, they supposed that they would receive (**MORE, LESS**); and they likewise received each a denarius."

MATTHEW 20:10

TRUE OR FALSE:

8. "Is it not lawful for me to do what I wish with my own things? Or is your eye evil because I am good?" MATTHEW 20:15

TRUE OR FALSE

215. PARABLE OF THE WORKERS IN THE VINEYARD

(MATTHEW 20:1-16)

I	V	F	T	O	B	R	O	F	A	I	C	Y	L	H
N	M	D	I	H	O	O	N	A	W	B	N	V	O	H
T	T	D	H	M	R	J	N	W	V	O	L	Z	M	G
M	F	V	A	Z	B	T	B	W	Z	J	E	E	H	T
L	W	D	R	Y	B	Z	V	Z	Z	U	R	Y	L	J
N	N	E	E	D	N	D	S	O	M	B	A	S	W	J
T	Y	M	H	C	T	A	S	N	M	O	B	S	E	H
H	F	F	N	T	C	E	M	E	L	L	C	O	F	V
T	E	I	N	V	T	E	F	S	A	Y	A	I	T	F
P	D	R	S	E	N	A	A	O	S	F	E	S	C	O
N	R	S	K	W	P	D	M	H	T	D	I	A	T	P
C	L	T	I	O	S	D	V	C	E	A	L	R	T	B
B	B	L	Y	K	T	C	N	B	B	L	O	B	S	U
F	L	V	L	B	H	C	S	A	E	U	W	K	J	T
O	H	P	N	Z	E	L	W	D	M	Q	P	G	T	U

FIND THE WORDS OF THE VERSE AND THE SCRIPTURE REFERENCE BELOW IN THE PUZZLE ABOVE

"So the last will be first, and the first last. For many are called but few are chosen." MATTHEW 20:1

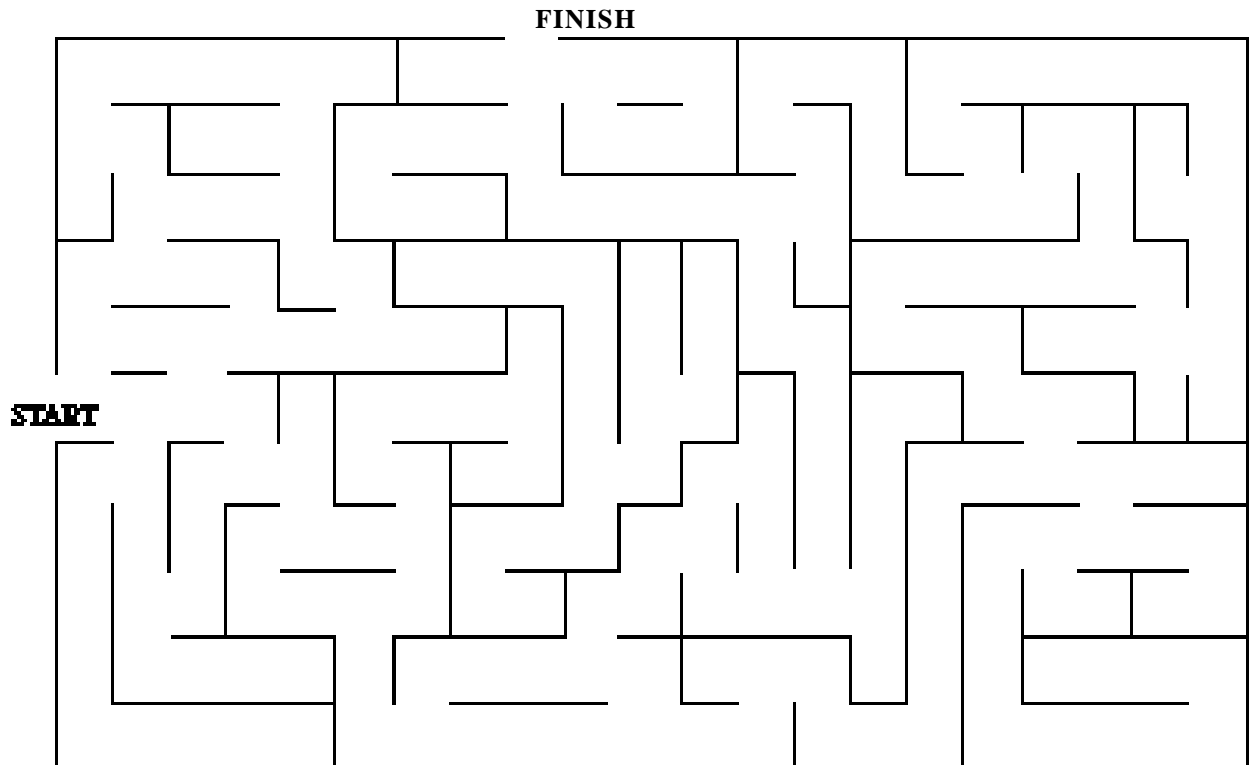

215. PARABLE OF THE WORKERS IN THE VINEYARD (MATTHEW 20:1-16)

MEMORY VERSE:

"So the last will be first, and the first last. For many are called, but few chosen." MATTHEW 20:16

"For the kingdom of heaven is like a landowner who went out early in the morning to hire laborers for his vineyard." MATTHEW 20:1

TRUE OR FALSE:

1. "Now when he had agreed with the laborers for a denarius a day, he sent them into his vineyard."
MATTHEW 20:2

TRUE OR FALSE

FILL IN THE BLANKS:

2. "And he went out about the third hour and saw others standing _____ in the marketplace."
MATTHEW 20:3
3. "...and said to them, 'You also go into the vineyard, and whatever is _____ I will give you.'..."
MATTHEW 20:4

UNDERLINE THE CORRECT ANSWER:

4. "Again he went out about the..."
- | | | |
|----|------------------|--------------|
| a. | sixth hour | MATTHEW 20:5 |
| b. | ninth hour | MATTHEW 20:5 |
| c. | eleventh hour | MATTHEW 20:6 |
| d. | all of the above | |

TRUE OR FALSE:

5. "So when evening had come, the owner of the vineyard said to his steward, 'Call the laborers and give them their wages, beginning with the last to the first.'" MATTHEW 20:8
TRUE OR FALSE

FILL IN THE BLANKS:

6. "And when those came who were hired about the eleventh hour, they each received a _____."
MATTHEW 20:9
7. "But when the first came, they supposed that they would receive _____; and they likewise received each a denarius."
MATTHEW 20:10

TRUE OR FALSE:

8. "Is it not lawful for me to do what I wish with my own things? Or is your eye evil because I am good?"
MATTHEW 20:15

TRUE OR FALSE

215. PARABLE OF THE WORKERS IN THE VINEYARD (MATTHEW 20:1-16)

Z H I K H B O Z I L D B N J P R T D H C L D F H E Y G M R Z
 Y U W W N R M K K T W Y D D U Q J O B B A Z Z W N H W E F H
 G B T B Y N H S E U S E Q W Z B D G F Y N N S Q T W T H Z R
 N T L D C Q R Q I D R B W Y N B C B F Q Z S Q I E H V L A V
 O B J B M S N V S J R R J H U V N B M R Q I G B E V Y B E Q
 H G D R R P N Z I I V A T S Q B U R A F C V H F V N N T M P
 S H U H C Z Z R R I Y G U M V J A W T V P W C U E K J C N R
 O E J Z B B Y D E U B T B K I P G G T K W P B L L W K A C Y
 T C U E C K Z R B G D I P Y Z U M G H G R C Q N Y B K P I P
 P R R B F E K C N Z D O D O S V F L E P A P Z Y E U A P P U
 W A H V E V B N P E I Y T H L B V N W W B Y S V C D D M M I
 N M T B B K G Y V G N M V I C M S K S Y W Z M J V Y H W H Q
 M S N J Q E Z I W M B B P Q B V J Y R T M O I A Q Q A M M R
 W Z T R Q W L R W S F W O B W S I B Z Y U C C G J S A M E K
 O W V K R B K P N O N S S L Q E B B W Q T U U I W N S D G C
 Z I F P V K J H D K J N T Z B B V B N Q Y W J I Y D Q A N V
 E B Y L Q K P B F T M S D M R O F U B N F O Y F U G T E H W
 B V I M M W N Y A A P I P M G J D Q B I E R K A B O U N E I
 P S Q D L Y N D W S Y M U N E P V I R V E H N S J N D P F L
 G B Y R I E F K A E K M T T N W T S K Q N Q B F N H M Y C L
 U B K E N R J S M C W Z Q K H W T L N D Q P O Y E Q S L S I
 B C R F I J N E S C Y K L F D E J B O A S O J V T H A Q N J
 A A A P C J K H L H E J Y L I C B U C N F K I L T S B Q Z S
 U W S L V G E N G O U Y A A L B P Z H E F K B M T A Q Y H U
 W H U Z L O W J J S A S I E W N L U Z V K B E O Q J Y C M D
 Z R F H S E U T B E T S G F S Y B R M T E U E M O B T G D S
 F T K S J H D Y S N N B Q Q H K P G T E H H G V S O N O E Z
 W C I T P G K G B R B D I B Y I Z D F N I S B Z B C V F W Y
 V H Z N C B P K S J I U G B K M R D N A G E V Y M F H B E H
 F Q A V E R W E E U L F T L E I B G N Y M B W C Z D K B Z K

FIND THE WORDS OF THE VERSE AND THE SCRIPTURE REFERENCE BELOW IN THE PUZZLE ABOVE

"So the last will be first, and the first last. For many are called but few are chosen." MATTHEW 20:16

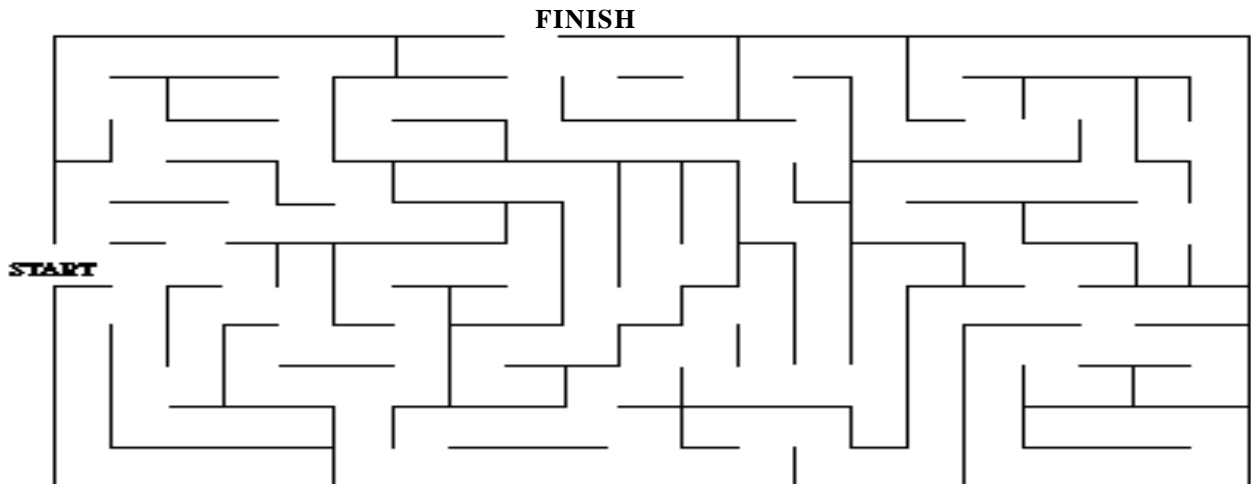

215. PARABLE OF THE WORKERS IN THE VINEYARD

(MATTHEW 20:1-16)

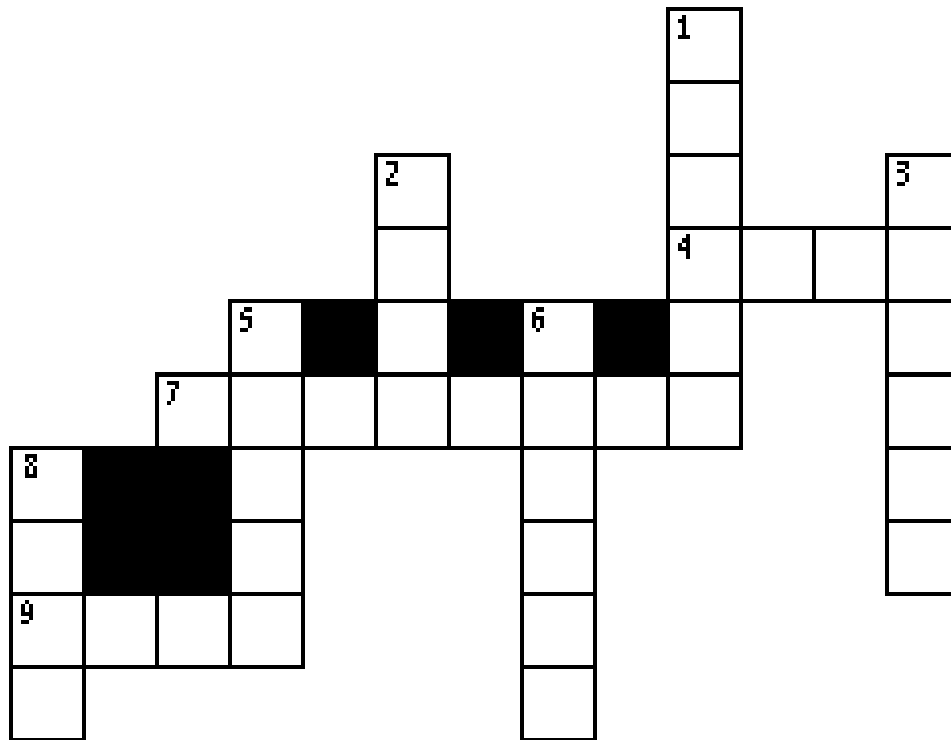

- 7 ACROSS "For the kingdom of heaven is like a landowner who went out early in the morning to hire laborers for his ____." **MATTHEW 20:1**
- 1 DOWN "Now when he had ____ with the laborers for a denarius a day, he sent them into his vineyard." **MATTHEW 20:2**
- 8 DOWN "And he went out about the third hour and saw others standing ____ in the marketplace." **MATTHEW 20:3**
- 5 DOWN "...and said to them, 'You also go into the vineyard, and whatever is ____ I will give you.'..." **MATTHEW 20:4**
- 9 ACROSS "So when evening had come, the owner of the vineyard said to his steward, 'Call the laborers and give them their wages, beginning with the ____ to the first.'" **MATTHEW 20:8**
- 4 ACROSS "And when those came who were hired about the eleventh hour, they ____ received a denarius." **MATTHEW 20:9**
- 2 DOWN "But when the first came, they supposed that they would receive ____; and they likewise received each a denarius." **MATTHEW 20:10**
- 6 DOWN "Is it not ____ for me to do what I wish with my own things? Or is your eye evil because I am good?" **MATTHEW 20:15**
- 3 DOWN "So the last will be first, and the first last. For many are called, but few ____." **MATTHEW 20:16**

Bible Story 216

ZACCHAEUS

LUKE 19:1-10

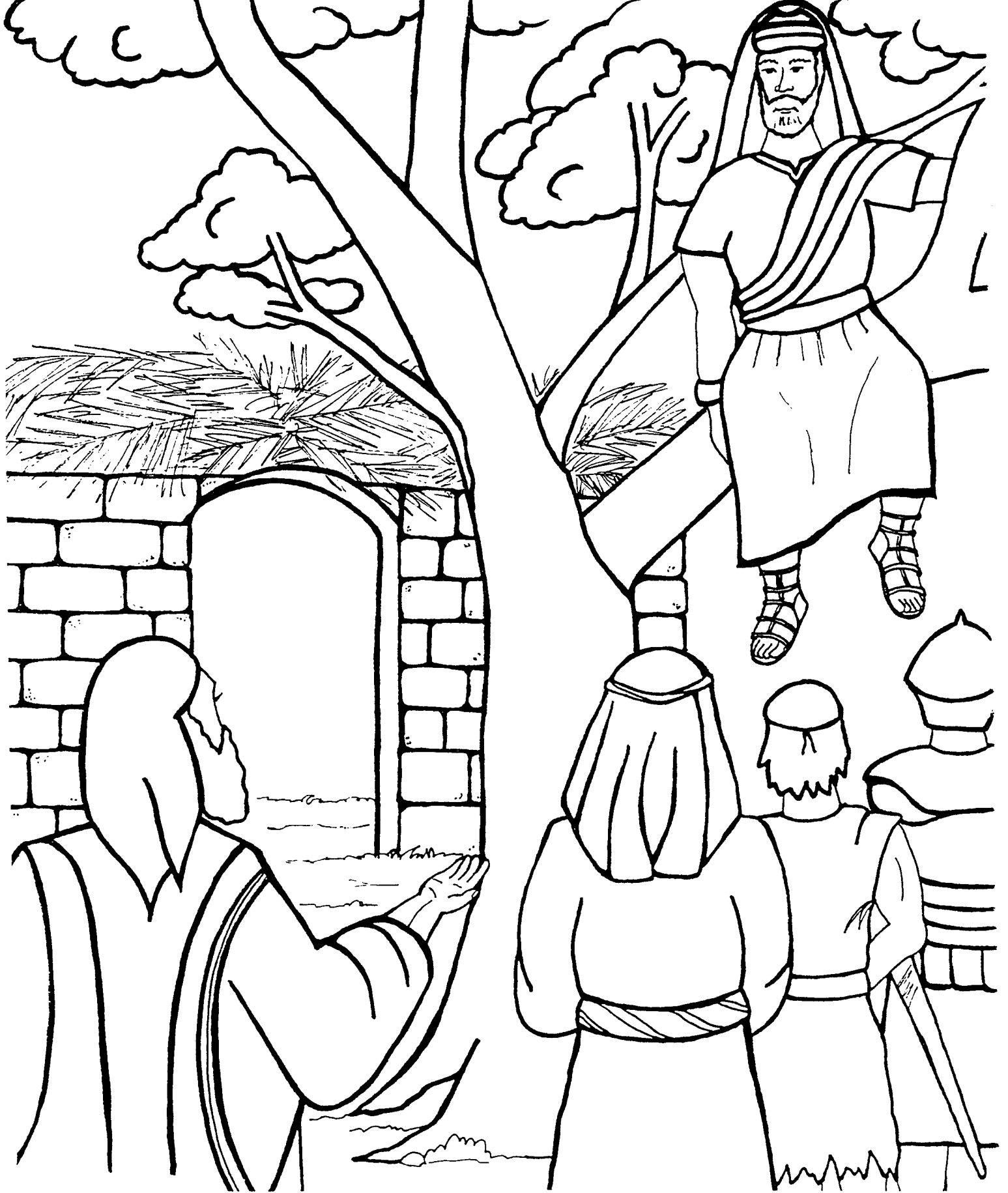

Zacchaeus climbed up into a sycamore tree to see Jesus.
LUKE 19:4

216. ZACCHAEUS

(LUKE 19:1-10)

MEMORY VERSE:

"... for the Son of Man has come to seek and to save that which was lost." LUKE 19:10

TRUE OR FALSE:

1. Now, behold, there was a man named Zacchaeus who was a chief tax collector, and he was poor. **LUKE 19:2**

TRUE OR FALSE

FILL IN THE BLANKS:

2. "And he sought to see who Jesus was, but could not because of the crowd, for he was _____ of stature." **LUKE 19:3**
3. "So he ran ahead and climbed up into a sycamore _____ to see Him, for He was going to pass that way." **LUKE 19:4**

TRUE OR FALSE:

4. "And when Jesus came to the place, He looked up and saw him, and said to him, 'Zacchaeus, make haste and come down, for today I must stay at your house.'" **LUKE 19:5**

TRUE OR FALSE

CIRCLE THE CORRECT WORDS:

5. "So he made haste and came down, and received Him (**JOYFULLY, SORROWFULLY**)."
LUKE 19:6
6. "Then Zacchaeus stood and said to the Lord, 'Look, Lord, I give (**NONE, HALF**) of my goods to the poor; and if I have taken anything from anyone by false accusation, I restore fourfold.'" **LUKE 19:8**

UNDERLINE THE CORRECT ANSWER:

7. "And Jesus said to him, 'Today _____ has come to this house...'" **LUKE 19:9**
 - a. a soldier
 - b. salvation
 - c. trouble

216. ZACCHAEUS

(LUKE 19:1-10)

P O T U W J H P R G V Q T H E
D N T Q R S U E E S B F I Z S
E D W D O T Q O U T O H S U G
B C F C F A S O W R S N A A D
O M E V A S S C J G Q O M A H
C F A N Q Z I M N R Y O L N E
P G M W T S L W S N A M T M P
O D F T A D S K H Q E P L G Z
G K E E S J J B Z I L T T M C
U T H I W Q F T K I C A Y H C
P A K A U I F N B P N H L A Q
M S S W U B O M Z H V T I W I
C O M E H T A H F Z Q J O X W
N T N P E D N L H I T T V P Z
R O C P R Y D D N V A B Q E K

FIND THE WORDS OF THE SCRIPTURE BELOW IN THE PUZZLE ABOVE

"For the Son of Man has come to seek and to save that which was lost."

LUKE 19:10

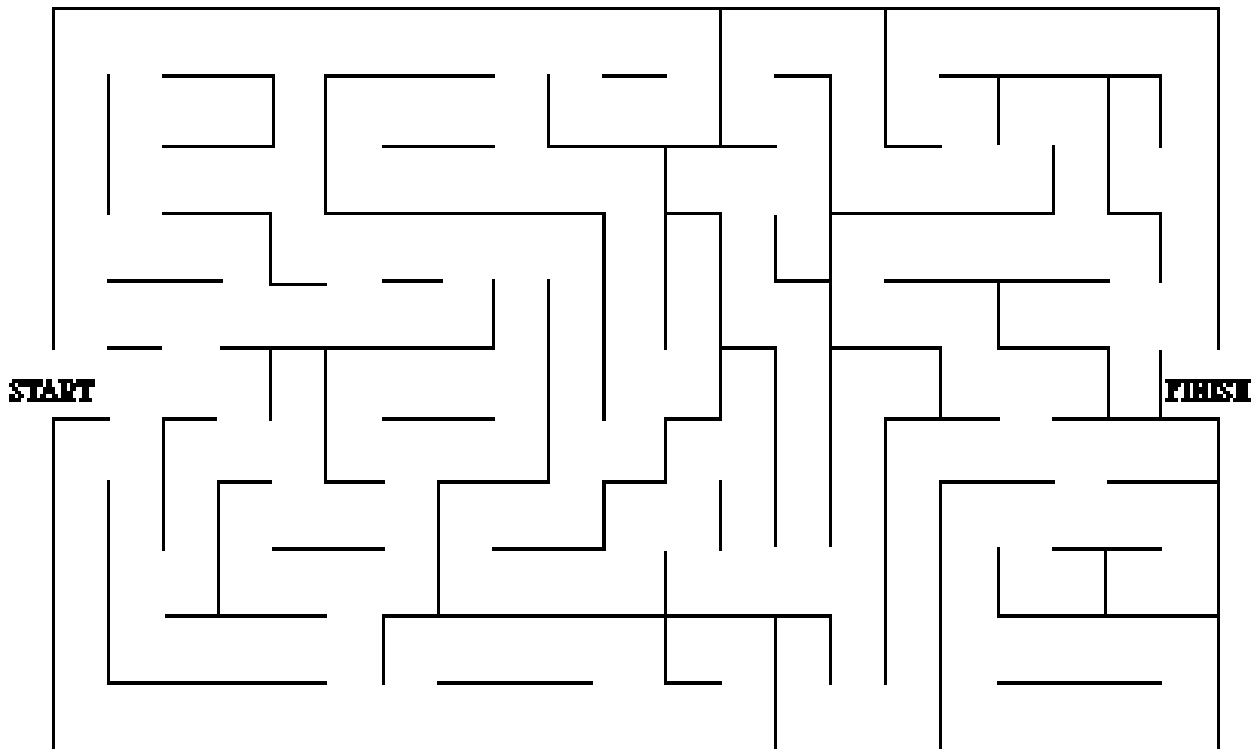

216. ZACCHAEUS

(LUKE 19:1-10)

MEMORY VERSE:

"... for the Son of Man has come to seek and to save that which was lost." LUKE 19:10

TRUE OR FALSE:

1. Now, behold, there was a man named Zacchaeus who was a chief tax collector, and he was poor. **LUKE 19:2**

TRUE OR FALSE

FILL IN THE BLANKS:

2. "And he sought to see who Jesus was, but could not because of the crowd, for he was _____ of stature." **LUKE 19:3**
3. "So he ran ahead and climbed up into a sycamore _____ to see Him, for He was going to pass that way." **LUKE 19:4**
4. "And when Jesus came to the place, He looked up and saw him, and said to him, 'Zacchaeus, make haste and come down, for today I must _____ at your house.'" **LUKE 19:5**

UNDERLINE THE CORRECT ANSWERS:

5. "So he..." **LUKE 19:6**
 - a. made haste
 - b. and came down
 - c. and received Him joyfully
 - d. all of the above
6. "Then Zacchaeus stood and said to the Lord, '...'" **LUKE 19:8**
 - a. Look, Lord, I give half of my goods to the poor
 - b. and if I have taken anything from anyone by false accusation, I restore fourfold
 - c. both of the above

FILL IN THE BLANK:

7. "And Jesus said to him, 'Today _____ has come to this house...'" **LUKE 19:9**

216. ZACCHAEUS

(LUKE 19:1-10)

R R H P V P N E Y V K F Y P E R A E L T E R J U I K Z D C Y
V F V R C U H N B B W B S S P D E J A C A U D R V M U P N Y
P H V X A T I Q B G L E M O K C I A I M E M D S S I I M M P
H E G O L N U X P D W H G L O S T V L P Q E R J M U J N N D
V L S S O D W N P C N T Z T J G W K R M U S M L K L L I S D
N M N L Z R A H Y Z W A S W F S A U U L T Z J P I W M B U A
C G B K M A F A I H Z L E I Y Q S O U C V P L B R V P R N W
O M K W F Z F Y F C O U J H T U S Z C S S J P F K K S Q E Z
Q B K V M E T Q O K H O T J W M G M Q G E E H T O G E I S C
L P O J Q M Q U J K A W M D U J J A N E T H O N Q R C J Y P
R M J L S D H Q W R K Q G U G Q P M R Y S D L S Y P H L T Y
H W Q W Q W A T S E U N O O H L Z Z U U A C T T C H M S A H
I N S E V Q U H S N N I O L X J F B K W V U F A Z K X J I E
D G P L P M U T I C B S V T V T B T B I E O P H A H I V L J
Y K M V B I T T A V D V S O S W N P I A K B N T K C V R E R
E B B D Q T T R G C L U P B B K K Z F C N S R L R O M R I L
D Y B D J A D R S C B B T I X M M F W L B Y A P V V T K A P
P K O Z I L D W W E F A W I H L Z V L P Y J P H Z N Q J K P
U P H Z C B Q P A H E D B B W W B F J A Z D L L Y J V S Q B
G U S O T Z C N F R L K H R Q G I H B I A A Y Q E L U F Y X
I Y S W C Z B P D E Y D J W T C Z N B N X K M U H D G Q R D
C F R H J N J B T M H W Y G P V F E K A U R T I Z R B V X T
E K V Q W K K C O Q X T K T L U Z E J M E B F C C Z D X T P
U T N I Y O S D M N O L P K J B X M K E D N H C S P O R P G
M G G L J B M W J Y I A S W B N D J U Y K Y D M G Y N B K B
M E D H T H J K K M R O O I J H K Q M A G N R R I A Z I Z A
K Y P T N F T I G A F A N U H B B V J Q C M S B F C J B O V
U G K Y A V A E H S Y P G M T A U E Y A M Q M G O E N Q V F
Y M S O S I A P G V M A K F J U Y V R O N P C M L M B H L R
Y Q P A L O U I D Y D D G O Y V E V T Y Q L E B B R A C C F

FIND THE WORDS OF THE SCRIPTURE BELOW IN THE PUZZLE ABOVE

"For the Son of Man has come to seek and to save that which was lost."

LUKE 19:10

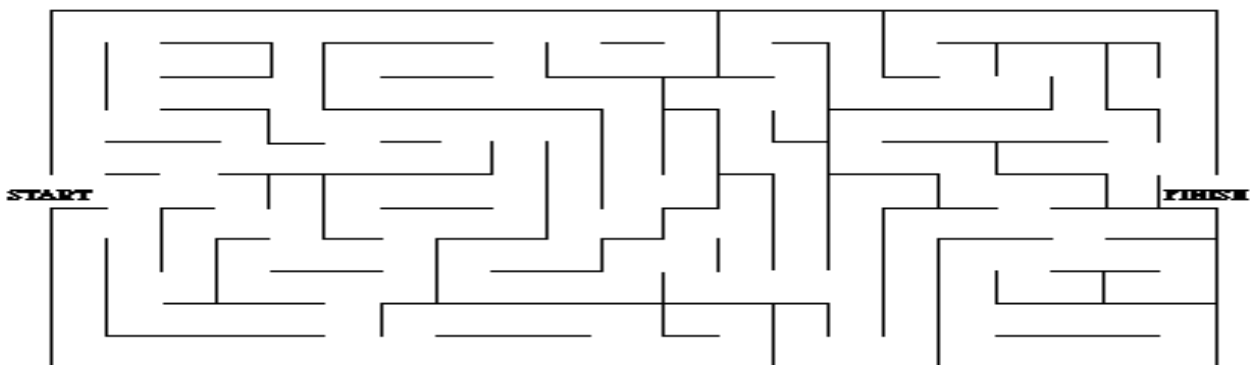

216. ZACCHAEUS

(LUKE 19:1-10)

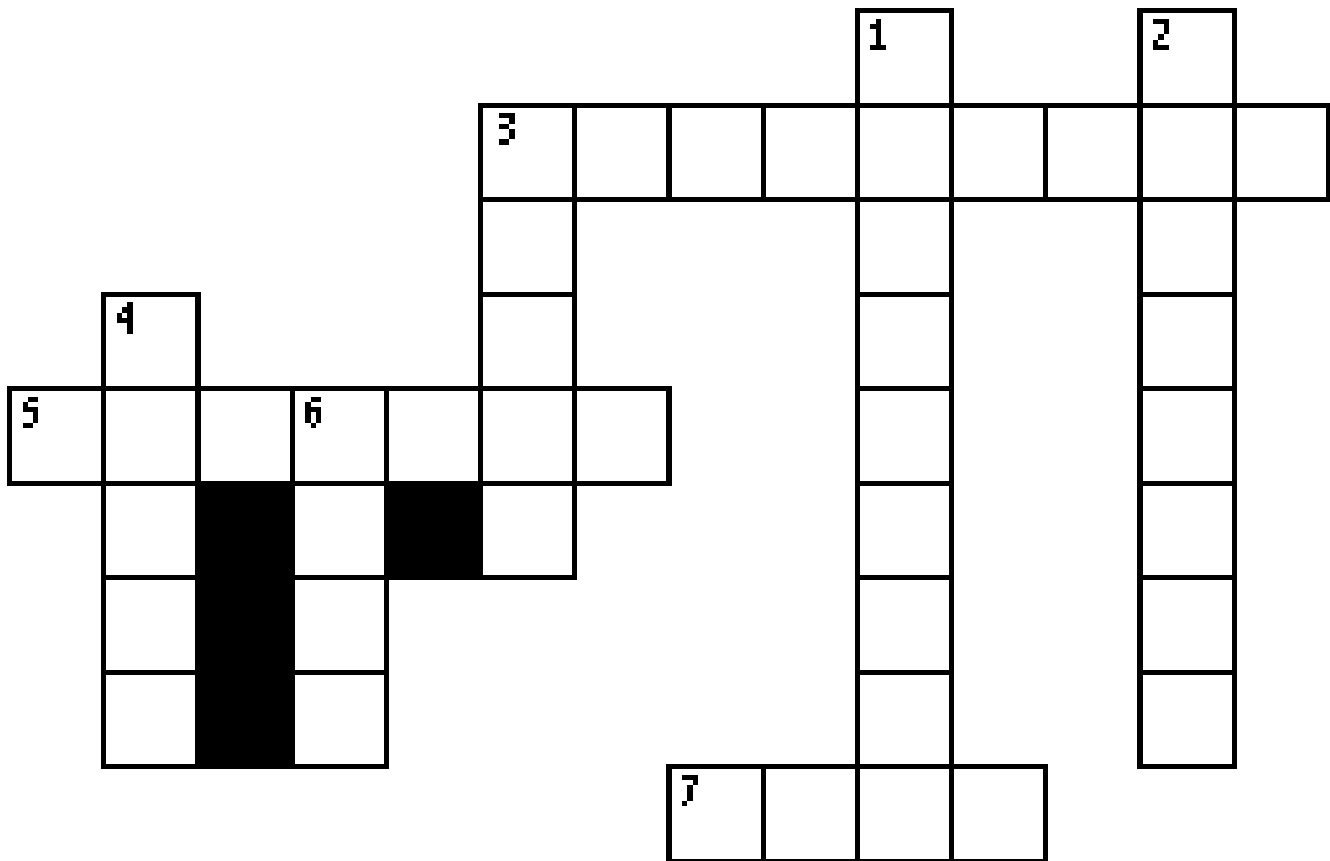

- 1 DOWN "Now, behold, there was a man named _____ who was a chief tax collector, and he was rich." **LUKE 19:2**
- 3 DOWN "And he sought to see who Jesus was, but could not because of the crowd, for he was _____ of stature." **LUKE 19:3**
- 6 DOWN "So he ran ahead and climbed up into a sycamore _____ to see Him, for He was going to pass that way." **LUKE 19:4**
- 4 DOWN "And when _____ came to the place, He looked up and saw him, and said to him, 'Zacchaeus, make haste and come down, for today I must stay at your house.'" **LUKE 19:5**
- 2 DOWN "So he made haste and came down, and received Him _____." **LUKE 19:6**
- 5 ACROSS "Then Zacchaeus stood and said to the Lord, 'Look, Lord, I give half of my goods to the poor; and if I have taken anything from anyone by false accusation, I _____ fourfold.'" **LUKE 19:8**
- 3 ACROSS "And Jesus said to him, 'Today _____ has come to this house...'" **LUKE 19:9**
- 7 ACROSS "... for the Son of Man has come to seek and to save that which was _____." **LUKE 19:10**

Bible Story 217

**JESUS HEALS
BLIND
BARTIMAEUS**

Mark 10:46-52

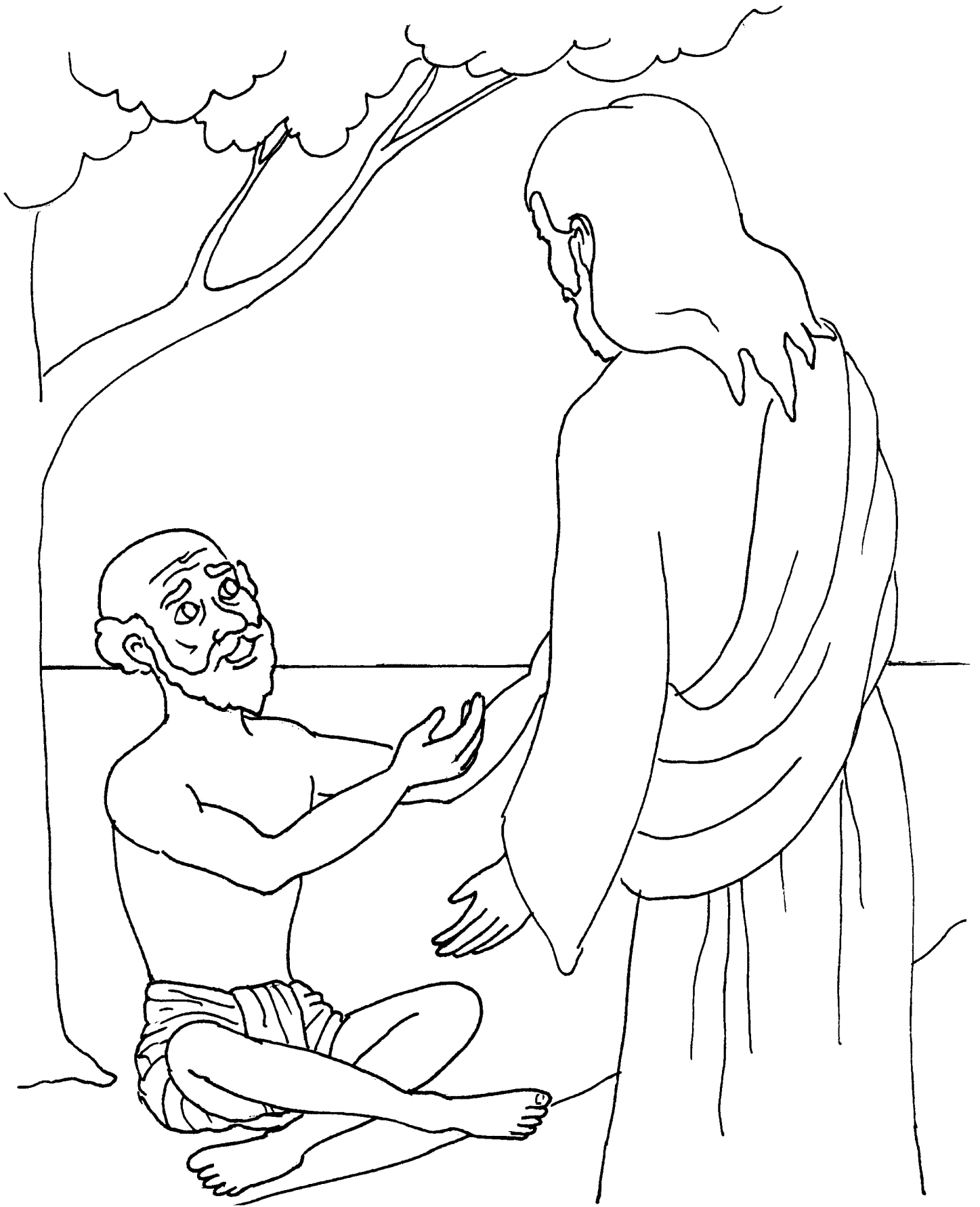

"Bartimaeus cries out to Jesus that he might receive his sight."
Mark 10:46-52

217. JESUS HEALS BLIND BARTIMAEUS

(MARK 10:46-52)

MEMORY VERSE:

"In that day the deaf shall hear the words of the book, and the eyes of the blind shall see out of obscurity and out of darkness. The humble also shall increase their joy in the LORD, and the poor among men shall rejoice in the Holy One of Israel." ISAIAH 29:18-19

TRUE OR FALSE:

1. "... And as He went out of Jericho with His disciples and a great multitude, blind Bartimaeus, the son of Timaeus, sat by the road begging." **MARK 10:46**

TRUE OR FALSE

2. "And when he heard that it was Jesus of Nazareth, he began to cry out and say, 'Jesus, Son of David, have mercy on me!' " **MARK 10:47**

TRUE OR FALSE

CIRCLE THE CORRECT WORD:

3. "Then many warned him to be (**LOUDER, QUIET**); but he cried out all the more, 'Son of David, have mercy on me!' " **MARK 10:48**

TRUE OR FALSE:

4. "So Jesus stood still and commanded him to be called. Then they called the blind man, saying to him, 'Be of good cheer. Rise, He is calling you.' " **MARK 10:49**

TRUE OR FALSE

5. "And Jesus answered and said to him, 'What do you want Me to do for you?' " **MARK 10:51**

TRUE OR FALSE

CIRCLE THE CORRECT WORD:

6. "The blind man said to Him, 'Rabboni, that I may receive my (**SIGHT, KITE**).' " **MARK 10:51**

FILL IN THE BLANK:

7. "Then Jesus said to him, 'Go your way; your _____ has made you well.' " **MARK 10:52**

CIRCLE THE CORRECT WORD:

8. "And immediately he received his sight and (**LEFT, FOLLOWED**) Jesus on the road." **MARK 10:52**

217. JESUS HEALS BLIND BARTIMAEUS

(MARK 10:46-52)

C D E H X G P F Q S Q Y A N G
J V H I V Q M J H L V L B O O
W A E T L C E U R B L N R S U
J I I J I L L E W M S D W H P
Q Z S H R H K M O I R C A B W
U P S B J U Y K I O S V Y S C
K M A C C C O B H Y O U Y Y P
K E H G J J B Y H R B O B J R
O O J H H K Z D Q K U O E N F
A G F G L V H C U R M A D E M
T E P Q Q O T Z Z E B S W D E
W R K P H B I R U Y Z K G Y T
L F A C Y Y A D M T F L F I L
G J R P O D F Y N E W D Z B M
G M K Q F G B Q V Z B F A L E

FIND THE WORDS OF THE SCRIPTURE BELOW IN THE PUZZLE ABOVE

"...Go your way; your faith has made you well." MARK 10:52a

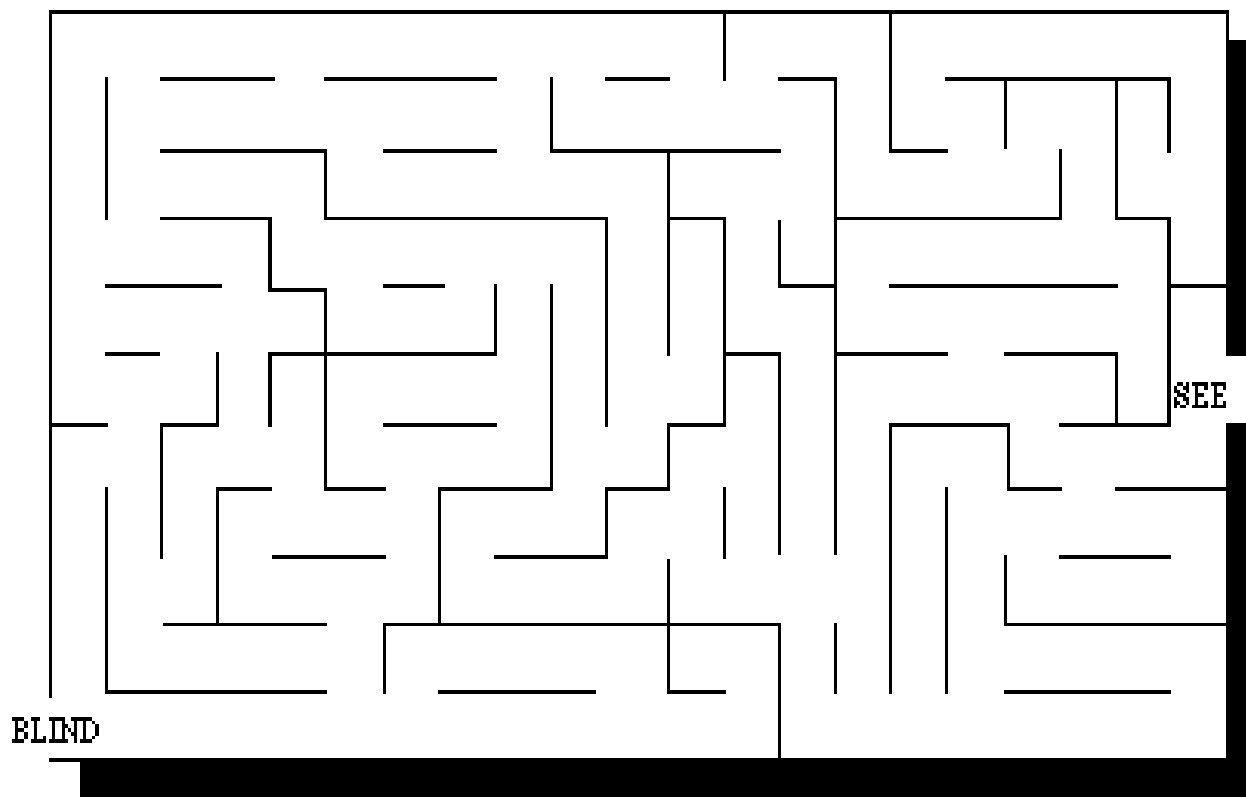

217. JESUS HEALS BLIND BARTIMAEUS

(MARK 10:46-52)

MEMORY VERSE:

"In that day the deaf shall hear the words of the book, and the eyes of the blind shall see out of obscurity and out of darkness. The humble also shall increase their joy in the LORD, and the poor among men shall rejoice in the Holy One of Israel." ISAIAH 29:18-19

TRUE OR FALSE:

1. "... And as He went out of Jericho with His disciples and a great multitude, blind Bartimaeus, the son of Timaeus, sat by the road begging." **MARK 10:46**
TRUE OR FALSE

FILL IN THE BLANKS:

2. "And when he heard that it was Jesus of Nazareth, he began to cry out and say, 'Jesus, Son of David, have _____ on me!' " **MARK 10:47**
3. "Then many warned him to be _____; but he cried out all the more, 'Son of David, have mercy on me!' " **MARK 10:48**

TRUE OR FALSE:

4. "So Jesus stood still and commanded him to be called. Then they called the blind man, saying to him, 'Be of good cheer. Rise, He is calling you.' " **MARK 10:49**
TRUE OR FALSE
5. And throwing aside his helmet, he rose and came to Jesus. **MARK 10:50**
TRUE OR FALSE
6. "And Jesus answered and said to him, 'What do you want Me to do for you?' " **MARK 10:51**
TRUE OR FALSE

FILL IN THE BLANKS:

7. "The blind man said to Him, 'Rabboni, that I may receive my _____.' " **MARK 10:51**
8. "Then Jesus said to him, 'Go your way; your _____ has made you well.' " **MARK 10:52**
9. "And immediately he received his sight and _____ Jesus on the road." **MARK 10:52**

217. JESUS HEALS BLIND BARTIMAEUS

(MARK 10:46-52)

N V L O V O N O M H V J L H M L P T F E M J G V L E A D J N
 O O O J V N Y K B G M C D C G C T V A S P O W Z R O E G F V
 Q I J I R C B J A U O V I O Q M L B Y Z P I K Q F N D W R V
 K Z W M F V P Q K Q N G P Y O G Z K B R N M K B W R B Z C B
 M E Z O W B V V I J G W M K T K T C C L I J O J Z L I A R W
 N M N Y P I U Z Y V I H W E H M T E M B D Z C W R X Z K L J
 R S Z D W J L P R Q C H L O K P B U B C L D T D F D F Z S L
 G W C V V A N Q U D N H G J W E S Z A R G C N Y M V A Y P E
 I Q U L G W Z L O D E B T S W I M B K K R A B N C Z O E E D
 V O L U J X H A Y D B X S I X P H E I G A B M K R L K A F C
 H E Z R T B R L T V P B Z Z A L V Q L W B B Q W I G O H Z V
 W R H S F Y A L F V U U R N L F Y A O T W L D H P R Q V L H
 I G Z S G K A M Z D U L O W R E M L Z D V I Y Q Z K S L V H
 E C M O J Y J S B K R Y J I Q P L B I C B H C O V E W V O A
 T I U V W T Y O C T J L L O C K M F J V Q V Z Z Q G Y R L H
 R G D Z J P G A S S Z H L V R S E H Z S J M Y F Q I U E Z B
 S M D D H S H L L H F N A M H N J V T D C E S L J V F R J E
 Q K V C G J S K S P J K G G N U L E T K A Y V Q S M I T P U
 A N V G B V E N N P M K H D N W D L I Y S Y P P D V E Q E D
 N R L O A D Q M P R E M G O V S Z C J F B S T S E O O S N J
 W F C P W T M G M B O D N T G C P J I S A H G V B V Z W R T
 V J L O H T B G N N R O W C R T E I J D W Q H U B O E S P Q
 V L V R P Q B T Q G I F B B K P B T R Q D K Q D L F R J I D
 W F N J R F C E Q B Y R Y V Z M L B B N I Y Z Z Q L I R R U
 K Z M Y U N B L H L S Q A N L S I I R N A J T O J J Y Q B V
 U V J M O F B S V L Y R W V M D A U B F J P W D A Y M U V D
 O K C G Y T Y V Z N D K W M I Q I M Q Y T A V U D T S S S E
 O C M U T H U P U N Y D B U V H R K A V L V X O I M I O D H
 Q D Y U Q D W Z D Z B F V O V E O X K D N T W X O H L K R M
 J Q S O X T D S F S O H B X T N N B L Y E P M T B Q N S F M

FIND THE WORDS IN THE SCRIPTURE BELOW IN THE PUZZLE ABOVE

"...Go your way; your faith has made you well." MARK 10:52a

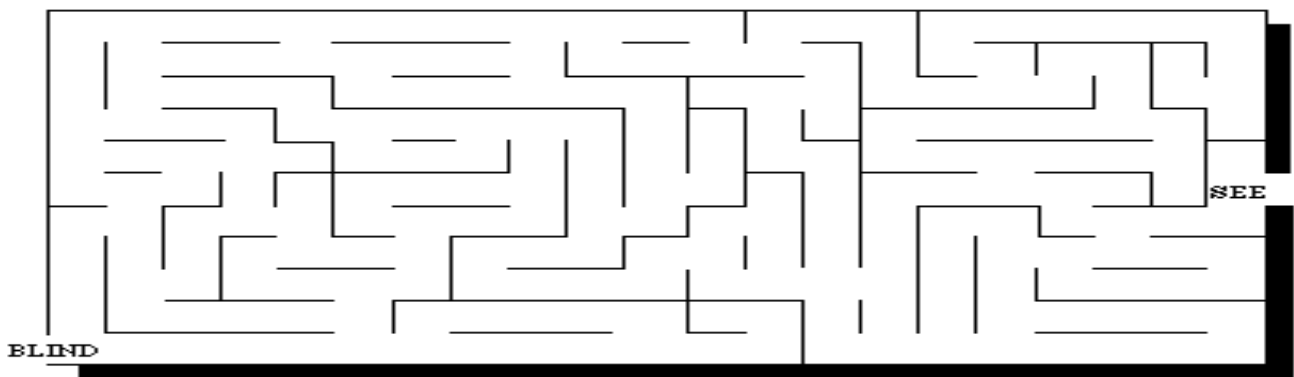

217. JESUS HEALS BLIND BARTIMAEUS

(MARK 10:46-52)

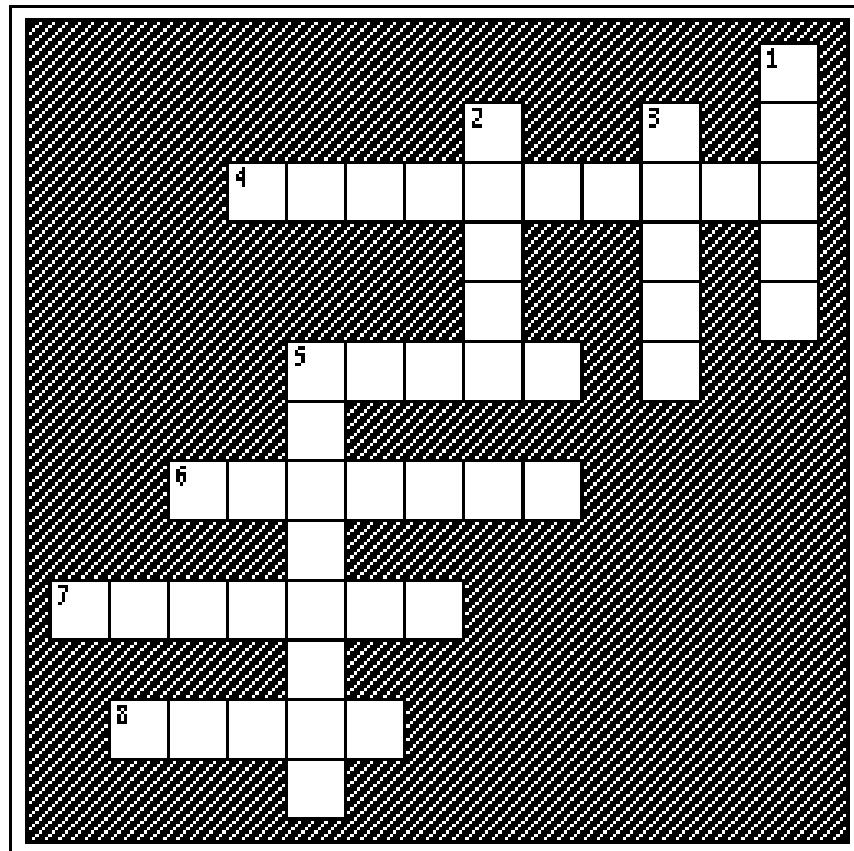

- 7 ACROSS "In that day the deaf shall hear the words of the book, and the eyes of the blind shall see out of obscurity and out of darkness. The humble also shall increase their joy in the LORD, and the poor among men shall rejoice in the _____ of Israel." **ISAIAH 29:18-19**
- 4 ACROSS "... And as He went out of Jericho with His disciples and a great multitude, blind _____, the son of Timaeus, sat by the road begging." **MARK 10:46**
- 3 DOWN "And when he heard that it was Jesus of Nazareth, he began to cry out and say, 'Jesus, Son of David, have _____ on me!' " **MARK 10:47**
- 8 ACROSS "Then many warned him to be _____; but he cried out all the more, 'Son of David, have mercy on me!' " **MARK 10:48**
- 6 ACROSS "So Jesus stood still and commanded him to be called. Then they called the blind man, saying to him, 'Be of good cheer. Rise, He is _____ you.' " **MARK 10:49**
- 1 DOWN "And _____ answered and said to him, 'What do you want Me to do for you?' " **MARK 10:51**
- 2 DOWN "The blind man said to Him, 'Rabboni, that I may receive my _____.'" **MARK 10:51**
- 5 ACROSS "Then Jesus said to him, 'Go your way; your _____ has made you well.'" **MARK 10:52**
- 5 DOWN "And immediately he received his sight and _____ Jesus on the road." **MARK 10:52**

Bible Story 218

**A STORY
ABOUT
INVESTING**

LUKE 19:11-27

218. A STORY ABOUT INVESTING

(LUKE 19:11-27)



"And he saith unto him, Out of thine own mouth will I judge thee, *thou* wicked servant. Thou knewest that I was an austere man, taking up that I laid not down, and reaping that I did not sow:"

LUKE 19:22

218. A STORY ABOUT INVESTING

(LUKE 19:11-27)

MEMORY VERSE:

"For I say to you, that to everyone who has will be given; and from him who does not have, even what he has will be taken away from him." LUKE 19:26

CIRCLE THE CORRECT WORD:

1. "Therefore He said: 'A certain nobleman went into a far country to receive for himself a (KINGDOM, RING) and to return.'" LUKE 19:12

TRUE OR FALSE:

2. So he called ten of his servants, delivered to them ten minas, and said to them, "Do nothing till I come." LUKE 19:13

TRUE OR FALSE

3. "And so it was that when he returned, having received the kingdom, he then commanded these servants, to whom he had given the money, to be called to him, that he might know how much every man had gained by trading." LUKE 19:15

TRUE OR FALSE

UNDERLINE THE CORRECT ANSWERS:

4. "Then came the first, saying, 'Master, your mina has earned...'" LUKE 19:16

10 minas

5 minas

0 minas

"And the second came, saying, 'Master, your mina has earned...'" LUKE 19:18

10 minas

5 minas

0 minas

"And another came, saying, 'Master, ...'" LUKE 19:20-21

here is your mina

I have kept it put away in a handkerchief

for I feared you...

all of the above

TRUE OR FALSE:

5. "And he said to him, 'Out of your own mouth I will judge you, you wicked servant...'" LUKE 19:22

TRUE OR FALSE

6. "And he said to those who stood by, 'Take the mina from him, and give it to him who has ten minas.'" LUKE 19:24

TRUE OR FALSE

218. A STORY ABOUT INVESTING

(LUKE 19:11-27)

G Z N E V I G P Y C O E W F P
Q Q M V W I R R U T M G O R D
P V R G L E G M V H V H N D H
C H M L Q A U A M E W V Y K M
H M I M L A J U Y Q O T D S Y
H W C Z Q Q E L A F O R H M N
E Z T D K R V M J J T Y I M K
H M Q I E P E I R N J E I Y S
J B F B M F R F O B T A H T S
K B D N H M Y L M H Z R A D V
E B H A Y Y O G Q Z O B S C Y
I Z A P O G N M D Y V W A P Z
M J S U R E E Y T Q L I Y L N
O R N N J W A V O P I B L R O
T S G A V K H Z U V C B N Z W

FIND THE WORDS OF THE SCRIPTURE BELOW IN THE PUZZLE ABOVE

"For I say to you, that to everyone who has will be given..." LUKE 19:26

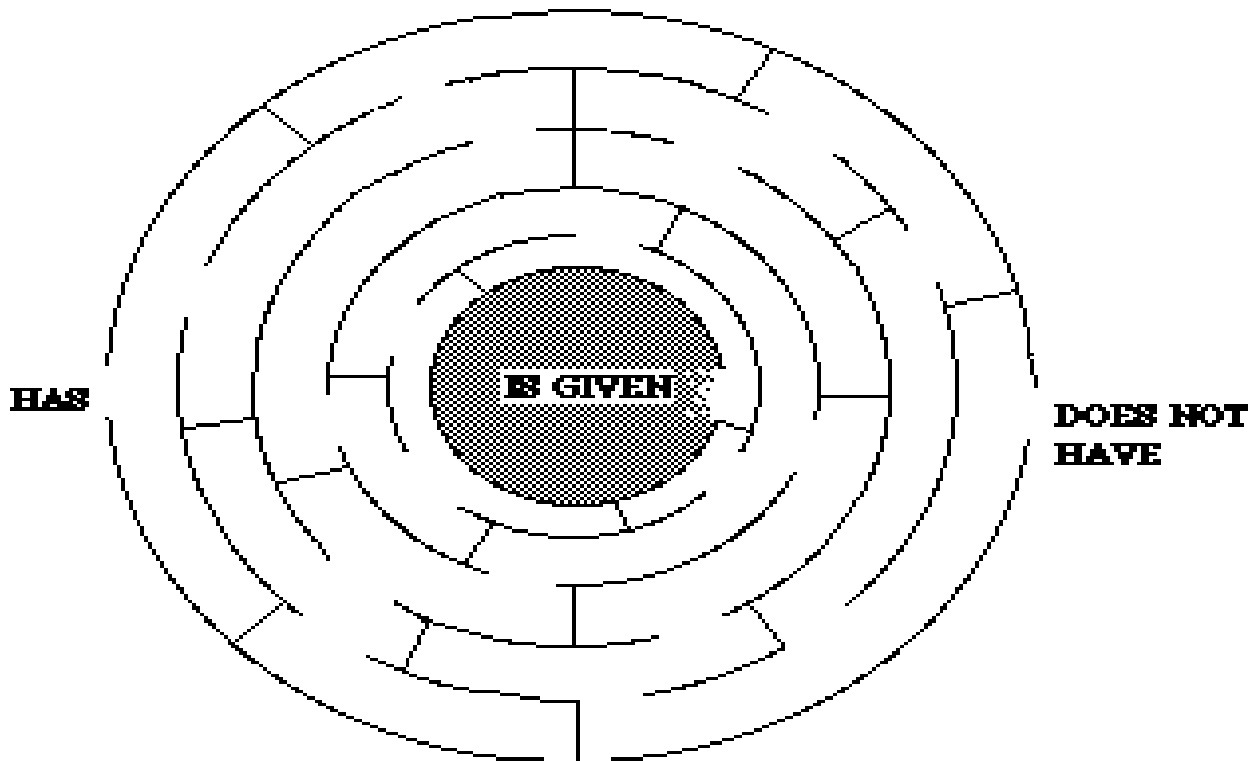

218. A STORY ABOUT INVESTING

(LUKE 19:11-27)

MEMORY VERSE:

"For I say to you, that to everyone who has will be given; and from him who does not have, even what he has will be taken away from him." LUKE 19:26

FILL IN THE BLANKS:

1. "Therefore He said: 'A certain nobleman went into a far country to receive for himself a _____ and to return.'" **LUKE 19:12**
2. So he called ten of his servants, delivered to them ten minas, and said to them, "Do _____ till I come." **LUKE 19:13**
3. "And so it was that when he returned, having received the kingdom, he then commanded these servants, to whom he had given the money, to be called to him, that he might know how much every man had _____ by trading." **LUKE 19:15**

UNDERLINE THE CORRECT ANSWERS:

4. "Then came the first, saying, 'Master, your mina has earned...'" **LUKE 19:16**
10 minas 5 minas 0 minas

"And the second came, saying, 'Master, your mina has earned...'" **LUKE 19:18**
10 minas 5 minas 0 minas

"And another came, saying, 'Master, ...'" **LUKE 19:20-21**
here is your mina
I have kept it put away in a handkerchief
for I feared you...
all of the above

TRUE OR FALSE:

5. "And he said to him, 'Out of your own mouth I will judge you, you wicked servant...'" **LUKE 19:22**

TRUE OR FALSE

FILL IN THE BLANKS:

6. "And he said to those who stood by, '_____ the mina from him, and _____ it to him who has ten minas.'" **LUKE 19:24**

218. A STORY ABOUT INVESTING

(LUKE 19:11-27)

F T X D E U U U H Q I N H T X D Y A U H M S E Y N K S A Z F
 T P Y Q V C E Q V K A E R N H T D I M U U G F B T Y A D C G
 V L A F Q N I C A P K G J C O U G V B M K O L B S Y K Z B E
 J W W I L Y L R M Q L H I I T N F D J F H J Y B G R G I C T
 X R A G Z H Q I O B Q Q Z T P M Y Z Q V K S D U W P I B B K
 C P P M I C V F B V F F Y B Q T Q P Z Z K H I G T E T B A G
 D O Q K M A Y J L R S V D J I Y N P A C D G R B V R Z H R E
 G S P A W K O N V I C B A C S Y Q S I R W L F C H M T I F T
 N L D B Z M F B O Y I W O F G Q V M R I W A V B J G A M F E
 F L C Y J K Y T C A C V B F L Y L F G M B C Q B M V L I B A
 E K B O A D E S E Q G G S I R M D B L B E D L K N L U B L
 I Y L O Q R U H M R C T T Y F L O U F U V S J Z W T I E H P
 V Z G K R L F W I S B E V E N T N Y Y R A U Z U R Z W I L A
 D J F O G C E U H L V T P D M T W V O T O O H N K O D M Q Q
 D O S A H W F J L Q D S Z Y Y J D K W H E M I V T M Z O G W
 A B D C B S F N W E P F B B T V N O A P K F O W A P Y D V C
 L D B S A B U D U Y A S N H B N N S B K V P H H D F O R W Q
 L Y Z H V I Q T Q M K E R Y J N M V C B M B I E O G S T G B
 S R H Y A B J G S B T I I U N X L N E K A T M U E B M F L U
 K D F H J F Y B P H E H N B A C R B I A P L A Z S N L Z K L
 F W N C K X O B O S O Q G L E N C F V J B B S R Z I A R B O
 U F I A G H W V B I Y W U H N B R G N P G D N O T U B M O M
 D V M Q G F H V J P N I X U Z O Z G B T Q N T Q S E V E B F
 G J P D J B O A B C T L R C M V Q I O O W H D E V K Y N G F
 F C B B J H E O U M T L W D D J A O C N J I Z T O I D O F R
 A M W B A B N M I Z A Y H I U J K G I C L B M O C H Q Y U N
 R I G V D A C E K E H W P O W Y I P G Z B C T Z M M W R O Q
 H B E K G P C I V L W W K W G S H R M F N H D K O Y B E W Z
 C S K V I G Z M J I H L T D R A B I D W A M O T S Q L V A H
 S I B H Y M C H K I G K R Q P P M D N T B Q U P Z M R E Q H

FIND THE WORDS FROM THE SCRIPTURE BELOW IN THE PUZZLE ABOVE

"For I say to you, that to everyone who has will be given; and from him who does not have, even what he has will be taken away from him." LUKE 19:26

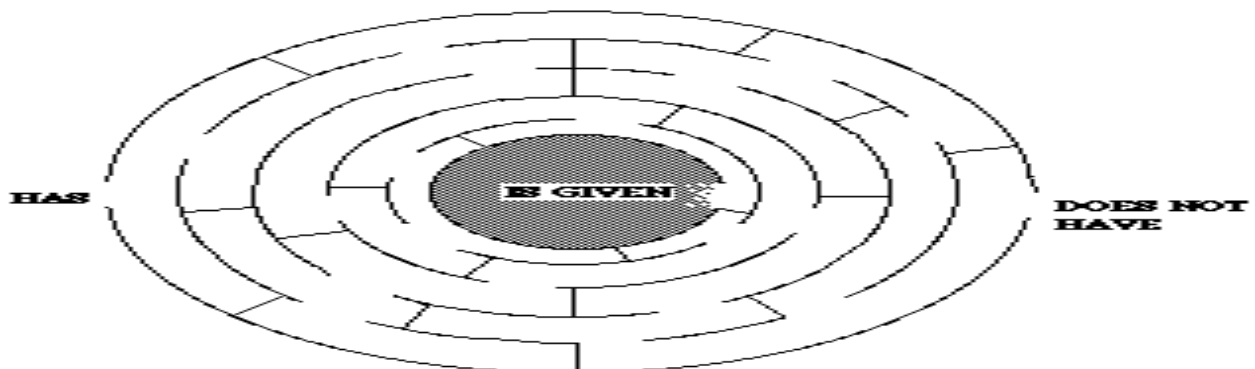

218. A STORY ABOUT INVESTING

(LUKE 19:11-27)

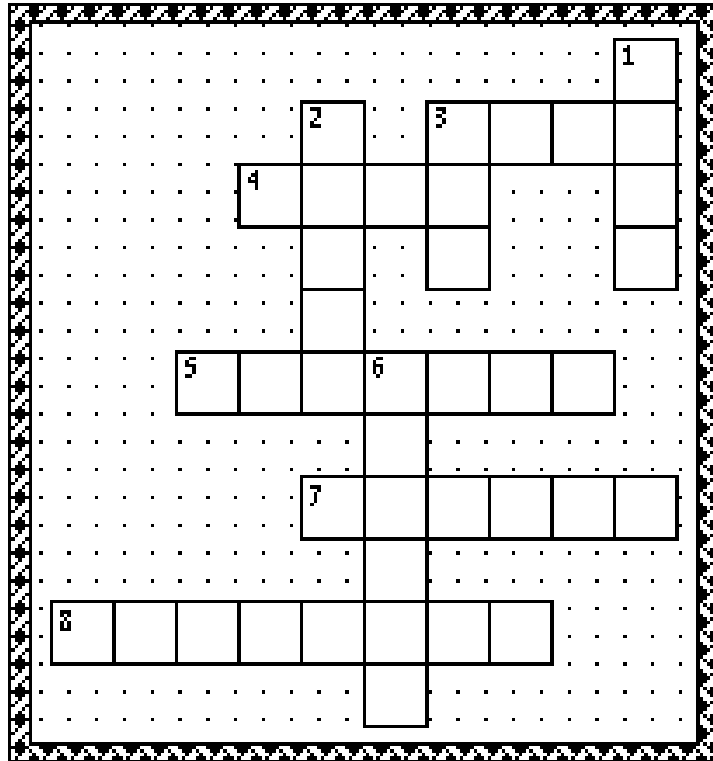

- 5 ACROSS "Therefore He said: 'A certain nobleman went into a far country to receive for himself a _____ and to return.'" **LUKE 19:12**
- 8 ACROSS "So he called ten of his servants, delivered to them ten minas, and said to them, 'Do _____ till I come.'" **LUKE 19:13**
- 6 DOWN "And so it was that when he returned, having received the kingdom, he then commanded these servants, to whom he had given the money, to be called to him, that he might know how much every man had _____ by trading." **LUKE 19:15**
- 3 DOWN "Then came the first, saying, 'Master, your mina has earned _____ minas.'" **LUKE 19:16**
- 4 ACROSS "And the second came, saying, 'Master, your mina has earned _____ minas.'" **LUKE 19:18**
- 1 DOWN "And another came, saying, 'Master, here is your mina, which I have _____ put away in a handkerchief. For I feared you...'" **LUKE 19:20-21**
- 7 ACROSS "And he said to him, 'Out of your own mouth I will judge you, you _____ servant...'" **LUKE 19:22**
- 3 ACROSS "And he said to those who stood by, '_____ the mina from him, and give it to him who has ten minas.'" **LUKE 19:24**
- 2 DOWN "For I say to you, that to everyone who has will be _____; and from him who does not have, even what he has will be taken away from him." **LUKE 19:26**

Bible Story 219

**MARY
ANNOINTS
JESUS' FEET**

JOHN 12:1-8



"Mary anoints Jesus' feet."
John 12:1-8

219. MARY ANOINTS JESUS' FEET

(JOHN 12:1-8)

MEMORY VERSE:

"Let her alone, she has kept this for the day of My burial. For the poor you have with you always, but Me you do not have always." JOHN 12:7-8

FILL IN THE BLANK:

1. "Then six days before the Passover, Jesus came to _____, where Lazarus was who had been dead, whom He had raised from the dead." JOHN 12:1

TRUE OR FALSE:

2. "There they made Him a supper; and Martha served, but Lazarus was one of those who sat at the table with Him." JOHN 12:2
TRUE OR FALSE
3. Then Mary took a pound of very costly oil of spikenard, anointed the feet of Jesus, and wiped His feet with her towel... JOHN 12:3
TRUE OR FALSE
4. "...And the house was filled with the fragrance of the oil." JOHN 12:3
TRUE OR FALSE
5. "Then one of His disciples, Judas Iscariot, Simon's son, who would betray Him, said, 'Why was this fragrant oil not sold for three hundred denarii and given to the poor?' " JOHN 12:4-5
TRUE OR FALSE

CIRCLE THE CORRECT WORDS:

6. "This he said, not that he cared for the poor, but because he was a (CHIEF, THIEF) and had the money box; and he used to take what was put in it." JOHN 12:6
7. "Then Jesus said, 'Let her alone; she has kept this for the day of My (BURIAL, BIRTH).'" JOHN 12:7

TRUE OR FALSE:

8. "For the poor you have with you always, but Me you do not have always." JOHN 12:8
TRUE OR FALSE

219. MARY ANOINTS JESUS' FEET

(JOHN 12:1-8)

M K V Y C B O H V S I J D T V
S W G Z K D L P N Y K R Q T H
A Q L M N R O W H A W O A J S
T I J M Z P O O R W B Z F G T
E Y O U Y C B P E L N E A A O
Q E C A I B Z K T A K H H Z L
F Q Y H L R Z Y O D A G H T S
T O T O W W V N N V C E D T T
U G U W U N A B E E H C W U R
N A N B Z F M Y V I P J Y J M
B D U E M O O A S L U X F D Z
T T Y V L R H J A Q M P Z O U
I B T W I T H J T S J D W Q O
T D F V M V A G E Z B J G K W
L L U N O N O J H G O P Z K E

FIND THE WORDS FROM THE SCRIPTURE BELOW IN THE PUZZLE ABOVE

"For the poor you have with you always, but Me you do not have always."

JOHN 12:8

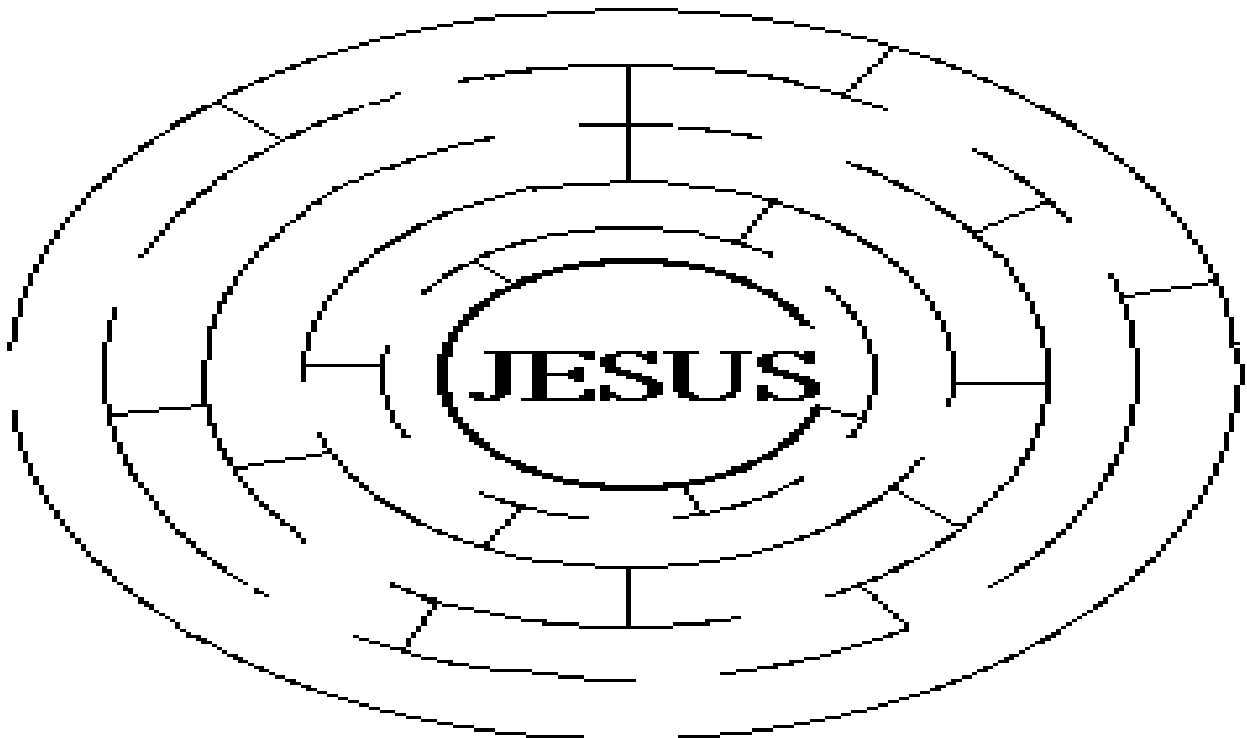

219. MARY ANOINTS JESUS' FEET

(JOHN 12:1-8)

MEMORY VERSE:

"Let her alone, she has kept this for the day of My burial. For the poor you have with you always, but Me you do not have always." JOHN 12:7-8

FILL IN THE BLANKS:

1. "Then six days before the Passover, Jesus came to _____, where Lazarus was who had been dead, whom He had raised from the dead." **JOHN 12:1**
2. "There they made Him a supper; and _____, but Lazarus was one of those who sat at the table with Him." **JOHN 12:2**
3. "Then _____ took a pound of very costly oil of spikenard, anointed the feet of Jesus, and wiped His feet with her hair." **JOHN 12:3**

TRUE OR FALSE:

4. "...And the house was filled with the fragrance of the oil." **JOHN 12:3**
TRUE OR FALSE
5. "Then one of His disciples, Judas Iscariot, Simon's son, who would betray Him, said, 'Why was this fragrant oil not sold for three hundred denarii and given to the poor?' " **JOHN 12:4-5**
TRUE OR FALSE

FILL IN THE BLANKS:

6. "This he said, not that he cared for the poor, but because he was a _____ and had the money box; and he used to take what was put in it." **JOHN 12:6**
7. "Then Jesus said, 'Let her alone; she has kept this for the day of My _____.'" **JOHN 12:7**

TRUE OR FALSE:

8. "For the poor you have with you always, but Me you do not have always." **JOHN 12:8**
TRUE OR FALSE

219. MARY ANOINTS JESUS' FEET

(JOHN 12:1-8)

W W F Y E W O J R J G O E F Z U W B E T P G Y Q R M D O I K
 I Q O L E V W J F M Q M B U O Y F R J E J C R K N F Z T Y G
 Z T V N D Z P H Z H V F M R P I S T P A Z F R L C O P Q Q F
 Z C M O C Z Y V I O Y W F I H C R A L P J B P B J S R T F O
 T Y T H C M V F D P H D Z J S W N M B C D D S R R B B L Q R
 F N F M L M Z O B D W R M N P Q C M C G D P W K Y J Y P Q T
 Y K W Z G M Y P K E E U S W J A R Q K G P I A Z U O Y W D M
 D K Y D G I S U L H N I W E Y R L S G R S F U E R A G V J S
 O W F C B B S U R R O B N Y V R V R S B V M O R B G L P O E
 W I E S V O O F O C O T O N M W F S Z S D M Y R E D N O H K
 S J D V Y J I R T K A F B R B Y C F Z N S P K V G Q G S N I
 R Q R E S A B D A W R O H Z B M K C L W U T B B I B B L R E
 Z L L K S B W Y L C B A G U M I E Q C Z B A S J B K B R L G
 B H B B F B K L S W T Z F I M D V E J S J N V S R A V E Y I
 C B H Z A O G M A O W H B R E V A S D T H G O S V U A R J O
 H G F B W Y L D K E T Q R V O E H V F H M A S Y A W L A J Z
 J I D O I D O B J U B H T B Z I B B K E U I V K I T J B C K
 L N D R T L P B B U A W E I O K D J V W N F F E N P A P H Z
 E T V B H O E Y R E N I F V J A C P Y R K H L P Q G O B S F
 O M D B O A M T Q H P Y Q V D D E A R Z K E H H I D U V E A
 O L M R V U L E C B M M P O E J Z R H K U Y P I Y R I J J T
 W N V T S Q T S T K Y H Y Y B T K R W A V I B T I K R L G U
 J T P C W C H H O F H W Z S Y B Y L M H W B W A J L J B E Q
 A H T N A E I A C S C N I K A W A E Q F E S L D W Q R X J W
 G T I P W S T O G Q G E N G J H D Q A A M D F D J I I J P E
 F P H O W N J I C V D L Q O T C B U L D Y B B B B W Q W O D
 F N N J Z L T Y C H O I T E W L V N G K U L B T K B N B B E
 M Y N T O B H W B K D Z V O H P Q H I T C G E T F I S A P D
 B C S Z B C H Y T P J J A N N I W N C B B H N A S R P S D K
 V B K D A E G M E W D Y B U A I B H T Q S C W H C R G V I T

FIND THE WORDS FROM THE SCRIPTURE BELOW IN THE PUZZLE ABOVE

***"Let her alone, she has kept this for the day of My burial. For the poor you have with you always, but Me you do not have always."* JOHN 12:7-8**

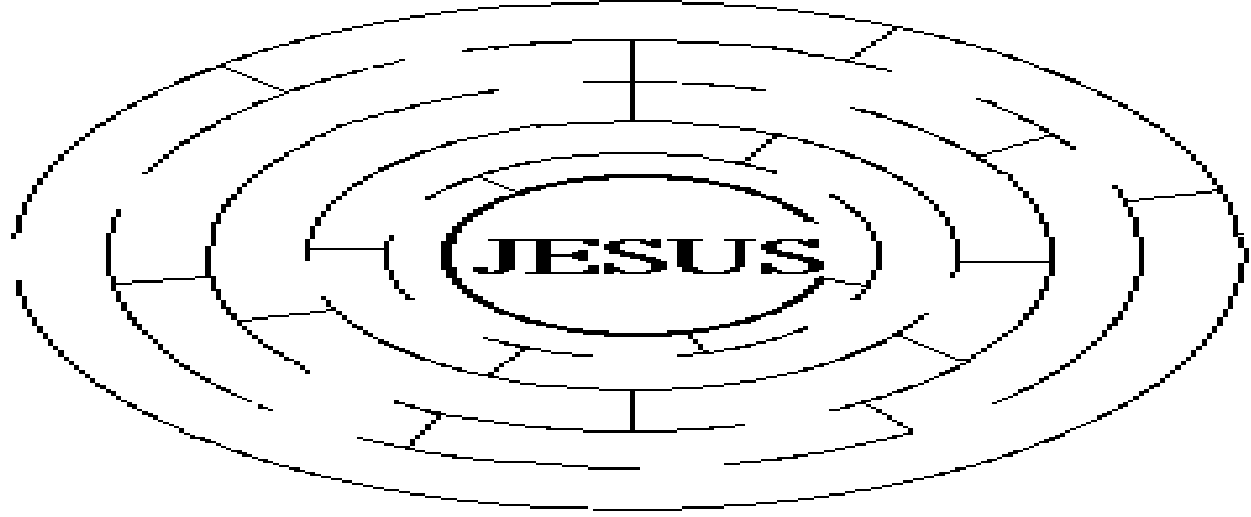

219. MARY ANOINTS JESUS' FEET

(JOHN 12:1-8)

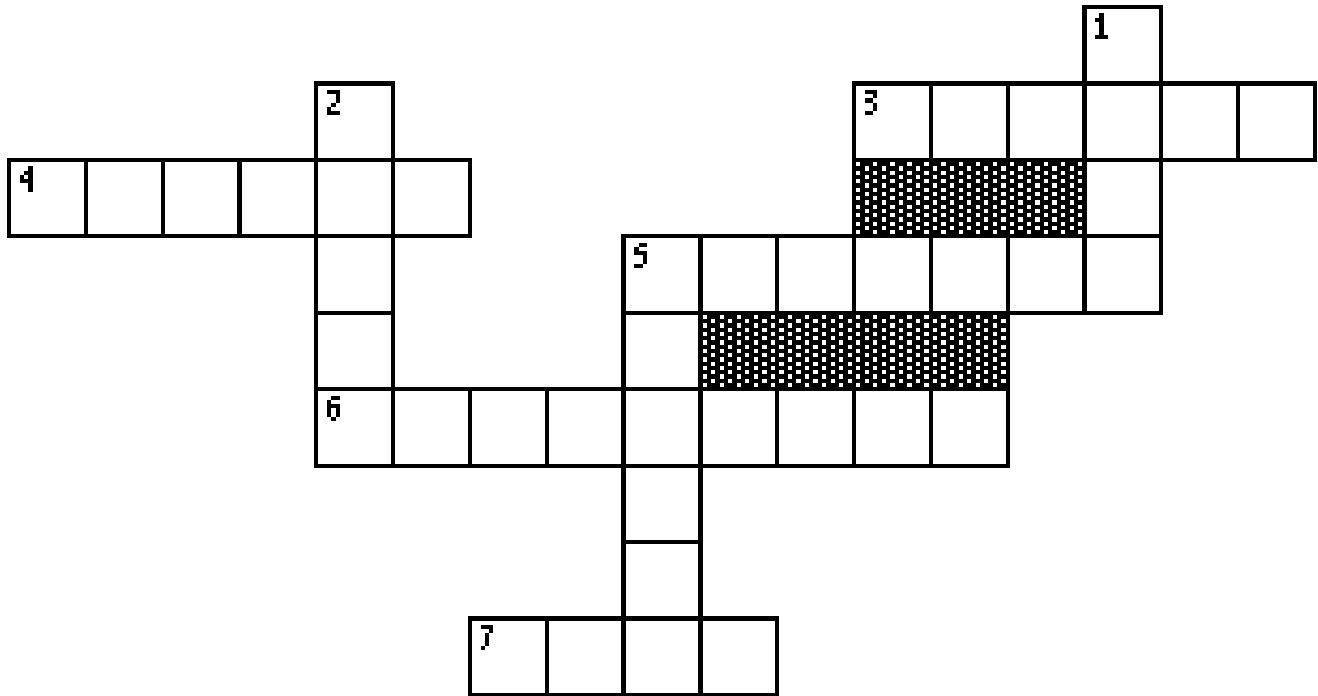

- 5 ACROSS "Then six days before the Passover, Jesus came to _____, where Lazarus was who had been dead, whom He had raised from the dead." **JOHN 12:1**
- 4 ACROSS "There they made Him a supper; and _____ served, but Lazarus was one of those who sat at the table with Him." **JOHN 12:2**
- 1 DOWN "Then _____ took a pound of very costly oil of spikenard, anointed the feet of Jesus, and wiped His feet with her hair"... **JOHN 12:3**
- 6 ACROSS "...And the house was filled with the _____ of the oil." **JOHN 12:3**
- 7 ACROSS "Then one of His disciples, Judas Iscariot, Simon's son, who would betray Him, said, 'Why was this fragrant oil not _____ for three hundred denarii and given to the poor?'" **JOHN 12:4-5**
- 2 DOWN "This he said, not that he cared for the poor, but because he was a _____ and had the money box; and he used to take what was put in it." **JOHN 12:6**
- 5 DOWN "Then Jesus said, 'Let her alone; she has kept this for the day of My _____.'" **JOHN 12:7**
- 3 ACROSS "For the poor you have with you _____, but Me you do not have always." **JOHN 12:8**

Bible Story 220

**THE
TRIUMPHAL
ENTRY INTO
JERUSALEM**

Matthew 21:1-11

220. THE TRIUMPHAL ENTRY INTO JERUSALEM (MATTHEW 21:1-11)



"And the multitudes that went before, and that followed, cried, saying, Hosanna to the Son of David: Blessed *is* he that cometh in the name of the Lord; Hosanna in the highest."

MATTHEW 21:9

220. THE TRIUMPHAL ENTRY INTO JERUSALEM

(MATTHEW 21:1-11)

MEMORY VERSE:

"...Hosanna to the Son of David! 'Blessed is He who comes in the name of the LORD!' Hosanna in the highest!" MATTHEW 21:9

CIRCLE THE CORRECT WORD:

1. "Now when they drew near to Jerusalem, and came to Bethphage, at the Mount of Olives, then Jesus sent two disciples, saying to them, 'Go into the village opposite you, and immediately you will find a **(ROPE, DONKEY)** tied, and a colt with her. Loose them and bring them to Me.' " MATTHEW 21:1-2

TRUE OR FALSE:

2. "And if anyone says anything to you, you shall say, 'The Lord has need of them,' and immediately he will send them." MATTHEW 21:3
TRUE OR FALSE
3. "All this was done that it might be fulfilled which was spoken by the prophet, saying: 'Tell the daughter of Zion, "Behold, your King is coming to you, lowly, and sitting on a donkey, a colt, the foal of a donkey." ' " MATTHEW 21:4-5
TRUE OR FALSE

CIRCLE THE CORRECT WORDS:

4. "They brought the donkey and the colt, laid their **(SADDLES, CLOTHES)** on them, and set Him on them." MATTHEW 21:7
5. "And a very great multitude spread their garments on the road; others cut down **(BRANCHES, FRUIT)** from the trees and spread them on the road." MATTHEW 21:8

TRUE OR FALSE:

6. "Then the multitudes who went before and those who followed cried out, saying: 'Hosanna to the Son of David! "**Blessed is He who** comes in the name of the LORD!" Hosanna in the highest!' " MATTHEW 21:9
TRUE OR FALSE
7. "So the multitudes said, 'This is Jesus, the prophet from Nazareth of Galilee.' " MATTHEW 21:11
TRUE OR FALSE

220. THE TRIUMPHAL ENTRY INTO JERUSALEM

(MATTHEW 21:1-11)



E	W	Q	V	K	B	T	C	C	B	V	E	R	Z	N
H	H	I	F	W	J	N	F	V	K	K	R	O	S	N
U	I	W	Y	B	R	V	E	S	I	E	J	E	K	T
B	B	T	I	D	K	H	N	J	M	W	N	M	H	F
T	V	L	Q	B	P	N	Q	P	M	D	J	E	M	J
B	S	J	Y	R	L	Y	Q	C	E	B	G	H	G	N
G	B	D	B	H	M	D	R	E	D	K	O	R	L	K
H	N	U	S	Z	D	N	V	B	I	K	H	O	Z	E
E	W	J	U	B	R	A	Q	R	A	Y	R	N	L	T
C	H	U	R	V	F	C	M	N	T	D	O	N	K	H
S	R	H	K	W	P	M	L	Q	E	W	G	U	T	E
R	H	T	I	I	Z	R	I	S	L	Y	B	H	J	M
M	T	A	Z	L	H	C	S	P	Y	S	E	Z	O	W
S	C	N	L	L	S	A	N	Z	E	M	A	Y	F	U
Z	H	T	A	L	H	B	I	D	E	E	N	Y	P	B

FIND THE WORDS IN THE SCRIPTURE BELOW IN THE PUZZLE ABOVE

"You shall say, 'The Lord has need of them,' and immediately he will send them." MATTHEW 21:3

220. THE TRIUMPHAL ENTRY INTO JERUSALEM

(MATTHEW 21:1-11)

MEMORY VERSE:

"...Hosanna to the Son of David! 'Blessed is He who comes in the name of the LORD!' Hosanna in the highest!" MATTHEW 21:9

FILL IN THE BLANKS:

1. "Now when they drew near to Jerusalem, and came to Bethphage, at the Mount of Olives, then Jesus sent two disciples, saying to them, 'Go into the village opposite you, and immediately you will find a _____ tied, and a _____ with her. Loose them and bring them to Me.' "
MATTHEW 21:1-2

TRUE OR FALSE:

2. "And if anyone says anything to you, you shall say, 'The Lord has need of them,' and immediately he will send them." **MATTHEW 21:3**
TRUE OR FALSE
3. "All this was done that it might be fulfilled which was spoken by the prophet, saying: 'Tell the daughter of Zion, "Behold, your King is coming to you, lowly, and sitting on a donkey, a colt, the foal of a donkey." ' " **MATTHEW 21:4-5**
TRUE OR FALSE

FILL IN THE BLANKS:

4. "They brought the donkey and the colt, laid their _____ on them, and set Him on them." **MATTHEW 21:7**
5. "And a very great multitude spread their garments on the road; others cut down _____ from the trees and spread them on the road." **MATTHEW 21:8**
6. "Then the multitudes who went before and those who followed cried out, saying: ' _____ to the Son of David! "Blessed is He who comes in the name of the LORD!" _____ in the highest!' " **MATTHEW 21:9**

TRUE OR FALSE:

7. "So the multitudes said, 'This is Jesus, the prophet from Nazareth of Galilee.'" **MATTHEW 21:11**
TRUE OR FALSE

220. THE TRIUMPHAL ENTRY INTO JERUSALEM (MATTHEW 21:1-11)



T T Z P D V B P D N A D B J M B D E F H V I C M F W V Y J B
 K Y A I I W L H R M Z A E L O C Y B D H C B P D J H L Y D W
 G L L S Q Q D M K Q S R J G E W V B H O B N T P E I M N T W
 Z W B T N A F O E R B I I S M H Y L L E T Y O M M B Z O N C
 M O Y E C O B A A U Q S T G D O Z T H K W Z L E L L A B M H
 I L R H G V I N W K Q J P T U E F B P Y C C E G A J L R A L
 N J L T R H D Z D B M I E R I F P O A J H M E B K A G M O S
 V Q W E C P M I I P B D U G P N T N D G D R B J P P F D O B
 B J N D L Y L O S S K D B C N H G B M Y L B E H O L D B C Y
 H B E O H C F S M J S V Y J B B A I T N E N T P A J J I A S
 Q B C B Z B F B E D Y D S H U I M W N L W K D L U F Z P D R
 C S J D C U E B C J Q Y B A I H V F Q R F A N F Q B L A K C
 Y F B T G O A L V B M D V N Z D O G C V A A F O K V U S D G
 B V C V O O A Y O C S S Z O E U L Z A Q O L B Z D G U W N V
 U K L I R J U Y O U B T J L F L B Y F B J U O Q H Y K J B K
 Y Y J Y Q C Q M R A H L U W F B Y Y H K T C P T V P P F L Z
 B M Y I B A I K P K V I F T E C W F Z H Z S E H E B L E O R
 H I D B B N W Q E D N A B W M J M B I A D R E E A Q P E I Y
 T H B M G Y L I G I C O L T F N T Q D N M D Z H O M J B H C
 R R T T Y R O I T G N I K Y G M C P E F D A E T B T D S F Q
 T Q R B K G D Z K H E P K A Q P P V J B B Q R W Z D I O U H
 A M B B Q U U Y V V D K O F P D B Y F C T R J B Q Q G B H Z
 F O Y J G Q U Q N T C Y D D O C S M B L B I U H V C T G D B
 V K T W V A C Y A D I F S B S F W C G Y T Q I O Q F E K A H
 L A O F O B T T B A U M A U L A Y B B R M T Z M Y S D Y V O
 I S H E L A I F Q C N T W E R E W F A A I O M O W P R T Q S
 V B N J F G N H Y Q J W F I K V D W J T R I T L M Y H C R F
 O P B M D F F N N C J F T N M I D B M D T T P Q J O R L L Z
 C V L I H P I N O R B K O A B L S D S V Q B L N R R V R I S
 E R F N F P P J D H C D D T D R I C P S A G M U J D O F Z H

FIND THE WORDS OF THE SCRIPTURE BELOW IN THE PUZZLE ABOVE

*"Tell the daughter of Zion, 'Behold, your King is coming to you,
Lowly, and sitting on a donkey, A colt, the foal of a donkey.'" MATTHEW 21:5*

220. THE TRIUMPHAL ENTRY INTO JERUSALEM

(MATTHEW 21:1-11)

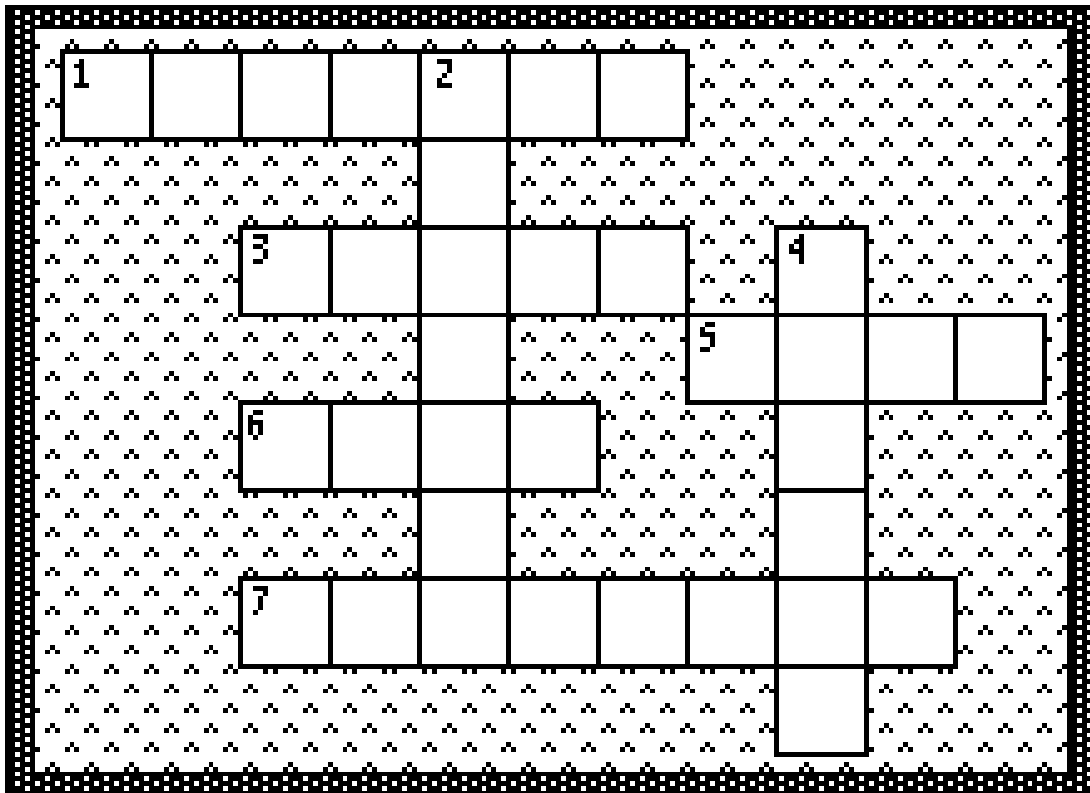

- 4 DOWN "Now when they drew near to Jerusalem, and came to Bethphage, at the Mount of Olives, then Jesus sent two disciples, saying to them, 'Go into the village opposite you, and immediately you will find a _____ tied, and a colt with her. Loose them and bring them to Me.'" **MATTHEW 21:1-2**
- 5 ACROSS "And if anyone says anything to you, you shall say, 'The _____ has need of them,' and immediately he will send them." **MATTHEW 21:3**
- 6 ACROSS "All this was done that it might be fulfilled which was spoken by the prophet, saying: 'Tell the daughter of Zion, "Behold, your _____ is coming to you, lowly, and sitting on a donkey, a colt, the foal of a donkey."' " **MATTHEW 21:4-5**
- 1 ACROSS "They brought the donkey and the colt, laid their _____ on them, and set Him on them." **MATTHEW 21:7**
- 7 ACROSS "And a very great multitude spread their garments on the road; others cut down _____ from the trees and spread them on the road." **MATTHEW 21:8**
- 2 DOWN "Then the multitudes who went before and those who followed cried out, saying: 'Hosanna to the Son of David! "Blessed is He who comes in the name of the LORD!" _____ in the highest!' " **MATTHEW 21:9**
- 3 ACROSS "So the multitudes said, 'This is _____, the prophet from Nazareth of Galilee.'" **MATTHEW 21:11**

Bible Story 221

**JESUS CLEANSSES
THE TEMPLE AGAIN**

LUKE 19:45-48

221. JESUS CLEANSSES THE TEMPLE AGAIN

(LUKE 19:45-48)



"And he went into the temple, and began to cast out them that sold therein, and them that bought; Saying unto them, It is written, My house is the house of prayer: but ye have made it a den of thieves."

LUKE 19:45-46

221. JESUS CLEANSSES THE TEMPLE AGAIN

(LUKE 19:45-48)

E R M B J I L L N B J G B F O
D P U H Q P X J Y M W R B V J
A T I O I H R Y B D E C Y W C
M I N S Y U Y A F T J L K Q A
O Y V T J Q R O Y V H O U S E
Y Q B B B M L D L E M H Q A T
B Y H T H K W B F I R Z G H Y
L F Q O B S N T P Y I C I V X
L M U V S B E R I I N E V H G
C S C I E V A H S B V A O P U
E T Y V F P F B T E N G L Y Q
A K B O V V C O S M D E F C A
T U B C K R J Y E T I O D K B
A G U E Y Z B T D B Q R D U A
S Z Y T M A C H O B C Q H O G

FIND THE WORDS OF THE SCRIPTURE BELOW IN THE PUZZLE ABOVE

"...My house is a house of prayer, but you have made it a 'den of thieves.' "

LUKE 19:46

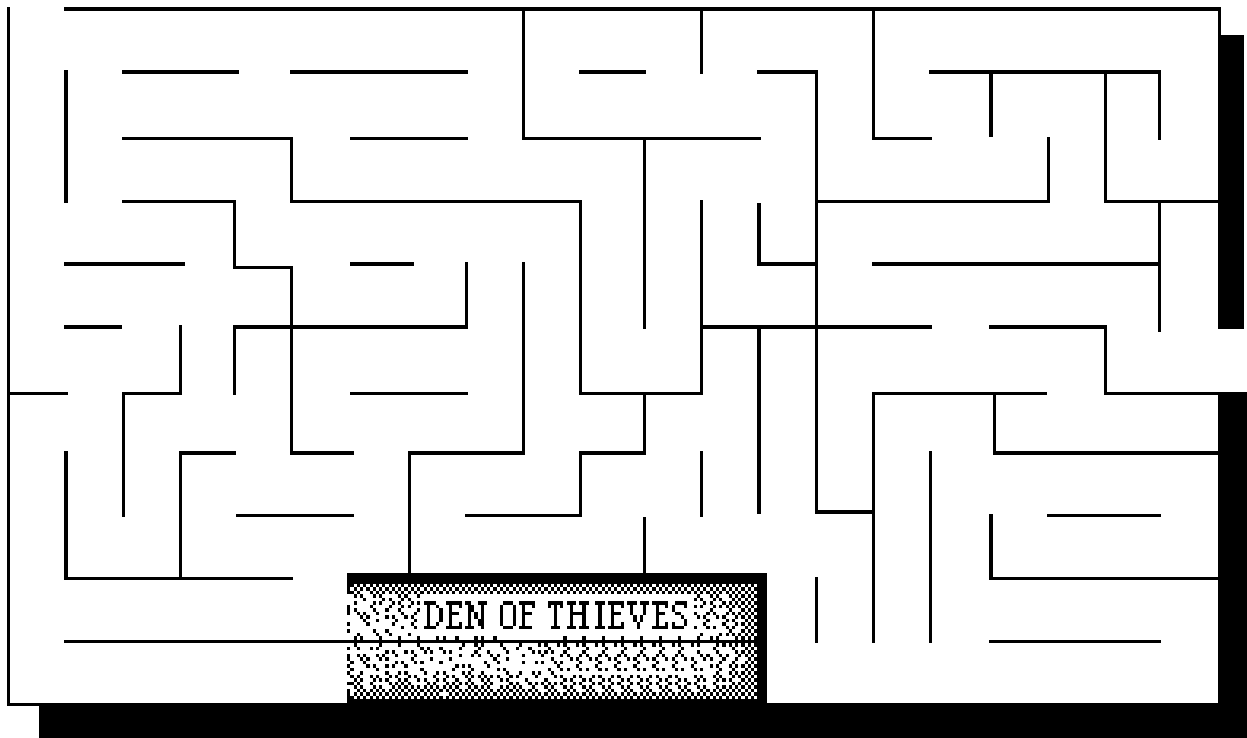

221. JESUS CLEANSSES THE TEMPLE AGAIN

(LUKE 19:45-48)

MEMORY VERSE:

"...It is written, "My house is a house of prayer," but you have made it a "den of thieves." ' ' "
LUKE 19:46

FILL IN THE BLANKS:

1. "Then He went into the _____ and began to _____ those who bought and sold in it." LUKE 19:45

TRUE OR FALSE:

2. "...It is written, "My house is a house of prayer," but you have made it a "den of thieves." ' ' "
LUKE 19:46

TRUE OR FALSE

FILL IN THE BLANKS:

3. "And He was _____ in the temple..." LUKE 19:47

UNDERLINE THE CORRECT ANSWER:

4. "...But the chief priests, the scribes, and leaders of the people sought to ____ Him." LUKE 19:47
- a. crown
 - b. destroy
 - c. help

FILL IN THE BLANK:

5. "... and were _____ to do anything; for all the people were very attentive to hear Him."
LUKE 19:48

221. JESUS CLEANSSES THE TEMPLE AGAIN

(LUKE 19:45-48)

P H U B B D E S L G F L O A F A W M P H O P H W I Z I E N F
 V L B A C N V A L T I P B U M B P O J B B U N I E W H L B I
 E M E U B G Z G I E B Y U G N V D W B L K N G F J E C M I Z
 T O G O N B K T K J Q A K U D B I W E W H B G T B C V D C G
 E N J Q S R W W S T F Z D U P O A N G C Q J D G F I O R Z D
 N K B B S B C J K S Q Y O K S Y P T C E O E A F J B E G S R
 Y J E J C F O R L S H G Z Q J F A K C B Z U M O H M G V T K
 P Z E Z E S C G S A G K S I B S B S K B E H J C S K Z G J S
 S C J H T Z E T Q W M V E E L W I G J A L A K O T T B O V A
 Q K H P H V D B V F F J S A N U L M T L T P V R R B T Q M N
 I T F D C U H D D S F U O P A Y Q O P S C E Y V E K V M M B
 G W N O P W N A I B O B F W E U T U L C I S L U Y P T P N K
 I Z C K A M S Y A H A U T H H H D I L M I A S F A I T V E V
 H A D W J N K H T I M U H Y T R H H B Y T J M L R B V S S H
 G M F L H Z Y D J T H E Q Q O A P V O M L E M M P W Y F U V
 G B Z O R I J E M M T J R J M H E G B B A F O B L O Q Y U N
 H G J U M J E E L K Z O M M G P J W W V K D I T H L L G G I
 D H L P A B Z E N Y H Z C A R E V C R F J V E B I I F U C F
 I J V O S D T M M M F S R I M J N M E B B S D M N Y Y A I N
 B R H Z V Q H W R W E D F Q M C E Y C K T F L I N T Q U R Q
 I B K A V Q T V W M A F D A H V C F A U B I P E M O I B O T
 T M O U M K E G Q B J K P F K R A Q H N L K D M A U F Z L Y
 I C Z N F M F T N B D T H Z B Y T A K E W D I A N L Z B S P
 G Y S Y H G F A W T B S T U G R V Z P B E J I N C L O W D K
 V K J K Q A J Z E P E H T I R E C P U G H Z B V C D J O A T
 S M K A B G K T Q H T A A V Y U P G C W R Y I T L K U D B P
 B D H T E D F A O W V Y S E V E I H T E C J F M F K D D H F
 Q S O C W I E U W B G V Y B D Z Q T H T U E W R I T T E N O
 Z H O B I B S R A Y F E U C R Y A B A Q V T E J S G B E M L
 G S B B N E D H N U B G U T J Z L D Y M O B L S L O Y G H D

FIND THE WORDS FROM THE SCRIPTURE BELOW IN THE PUZZLE ABOVE

"It is written, 'My house is a house of prayer,' but you have made it a 'den of thieves.' " LUKE 19:46

START

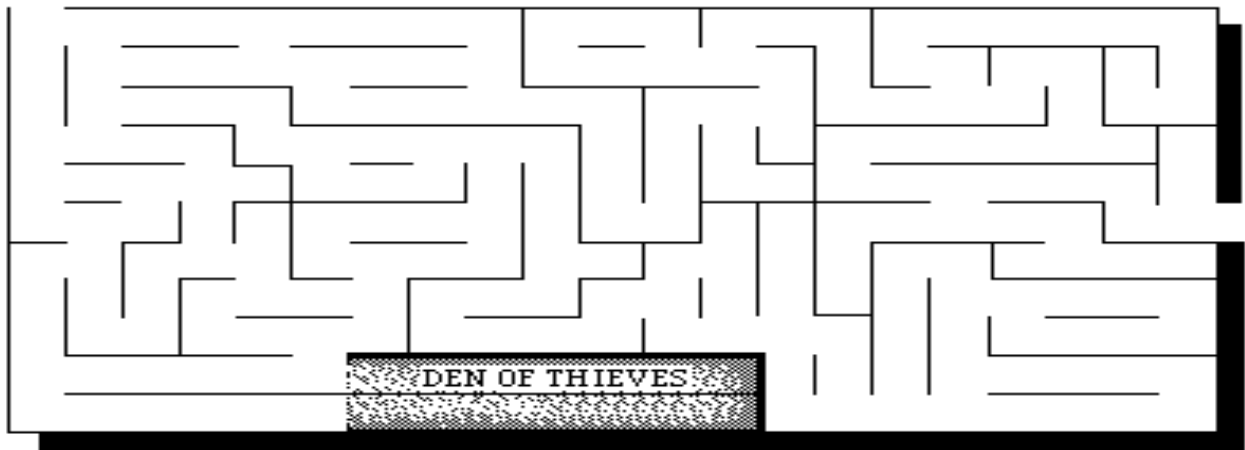

221. JESUS CLEANSSES THE TEMPLE AGAIN (LUKE 19:45-48)

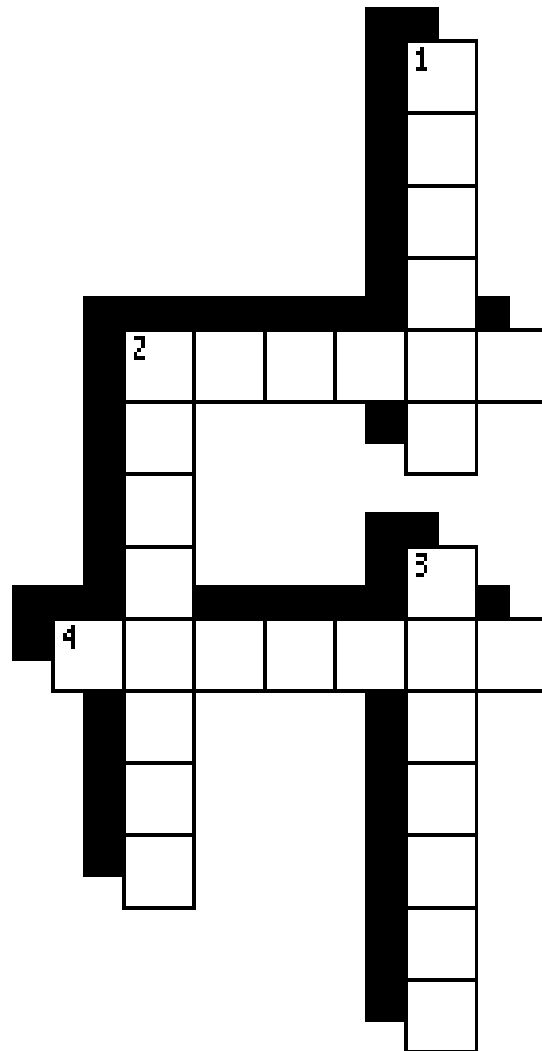

- 2 ACROSS "Then He went into the _____ and began to drive out those who bought and sold in it."
LUKE 19:45
- 4 ACROSS "...It is written, 'My house is a house of prayer,' but you have made it a 'den of _____.'"
LUKE 19:46
- 2 DOWN "And He was _____ daily in the temple..." **LUKE 19:47**
- 3 DOWN "...But the chief priests, the scribes, and leaders of the people sought to _____ Him."
LUKE 19:47
- 1 DOWN "... and were _____ to do anything; for all the people were very attentive to hear Him."
LUKE 19:48

Bible Story 222

**PARABLE
OF
TWO SONS**

Matthew 21:28-32

222. THE PARABLE OF THE TWO SONS (MATTHEW 21:28-32)

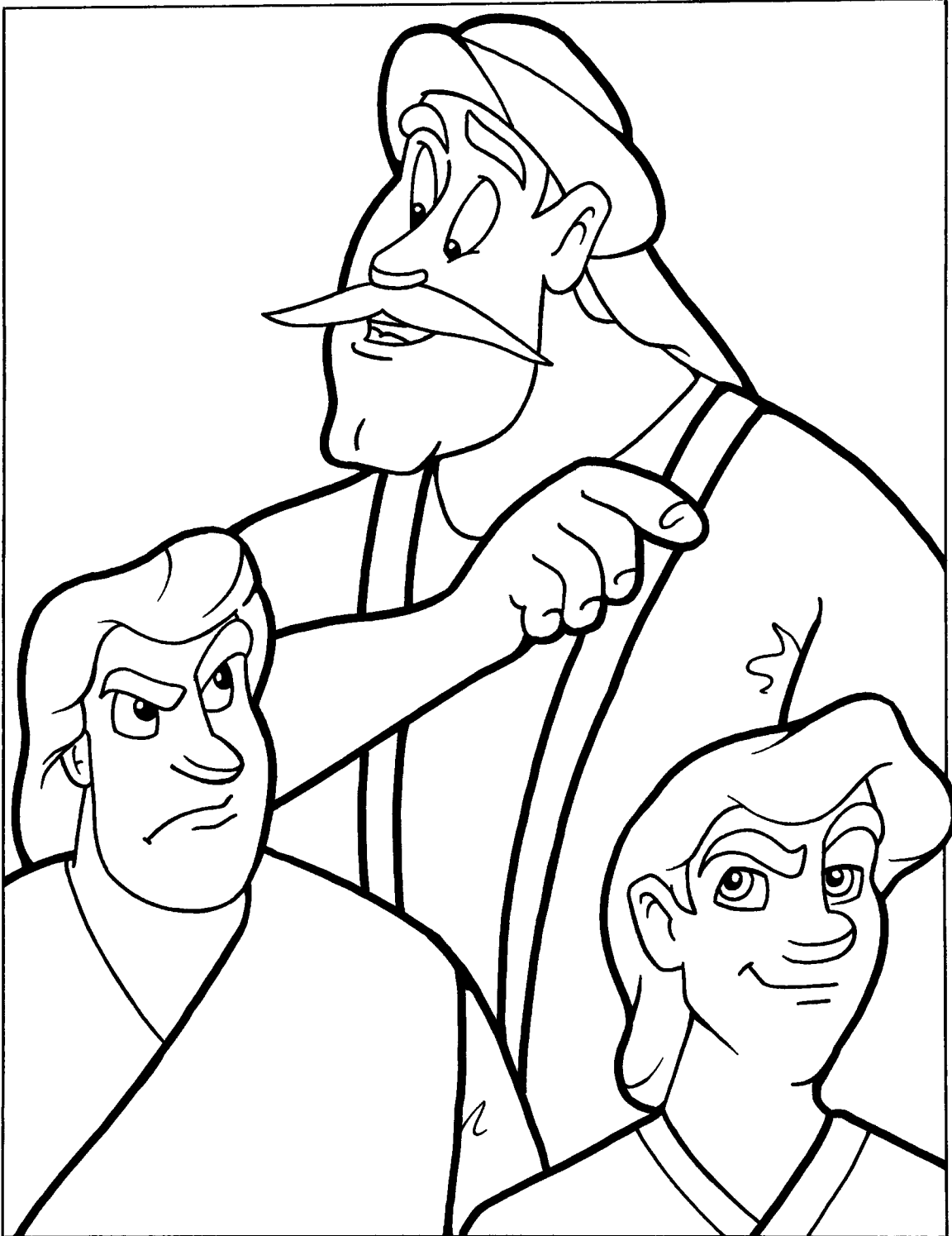

"But what think ye? A *certain* man had two sons; and he came to the first, and said, Son, go work to day in my vineyard. He answered and said, I will not: but afterward he repented, and went. And he came to the second, and said likewise.

And he answered and said, I *go*, sir: and went not."

MATTHEW 21:28-29-30

222. THE PARABLE OF THE TWO SONS (MATTHEW 21:28-32)

MEMORY VERSE:

"Children, obey your parents in all things, for this is well pleasing to the Lord."
COLOSSIANS 3:20

CIRCLE THE CORRECT WORD:

1. "... A man had (TWO, THREE) sons..." MATTHEW 21:28

TRUE OR FALSE:

2. "...and he came to the first and said, 'Son, go, work today in my vineyard.'" MATTHEW 21:28
TRUE OR FALSE

CIRCLE THE CORRECT WORD:

3. "He answered and said, 'I will not,' but afterward he regretted it and (WENT, STAYED)."
MATTHEW 21:29

TRUE OR FALSE:

4. "Then he came to the second and said likewise..." MATTHEW 21:30
TRUE OR FALSE

CIRCLE THE CORRECT ANSWER:

5. "... And he answered and said, 'I go, sir,' but he (DID, DID NOT) go." MATTHEW 21:30

Jesus asked, "Which of the two did the will of his father?..."

UNDERLINE THE CORRECT ANSWER:

6. "...They said to Him, '____.'" MATTHEW 21:31
a. the first
b. the second

222. THE PARABLE OF THE TWO SONS

(MATTHEW 21:28-32)

N J O H S O L M C E B N N F B
J G M R W R G U C O W T Q A B
V H I U N N T D W T R D D U F
L B H W H V B G W G Y J L Z O
M W E O D T T S R I F B F V B
I W P W R E P T U F D T H E C
T P M B H H K K B E I S Y G B
E B F H K T Q R E V D U D R V
E K A D I S T H E J G H I S N
H K T Y S H F M O P B M L W Y
M H H E F F F O D J S N L E K
Z N E H Z C V Y T I A S I G J
K L R T R W K V O T S S W D R
I A U B O D I A S B R H O R W
R R B F C N H A O W H I C H S

FIND THE WORDS FROM THE SCRIPTURE BELOW IN THE PUZZLE ABOVE

" 'Which of the two did the will of his father?' They said to Him, 'The first.' " MATTHEW 21:31

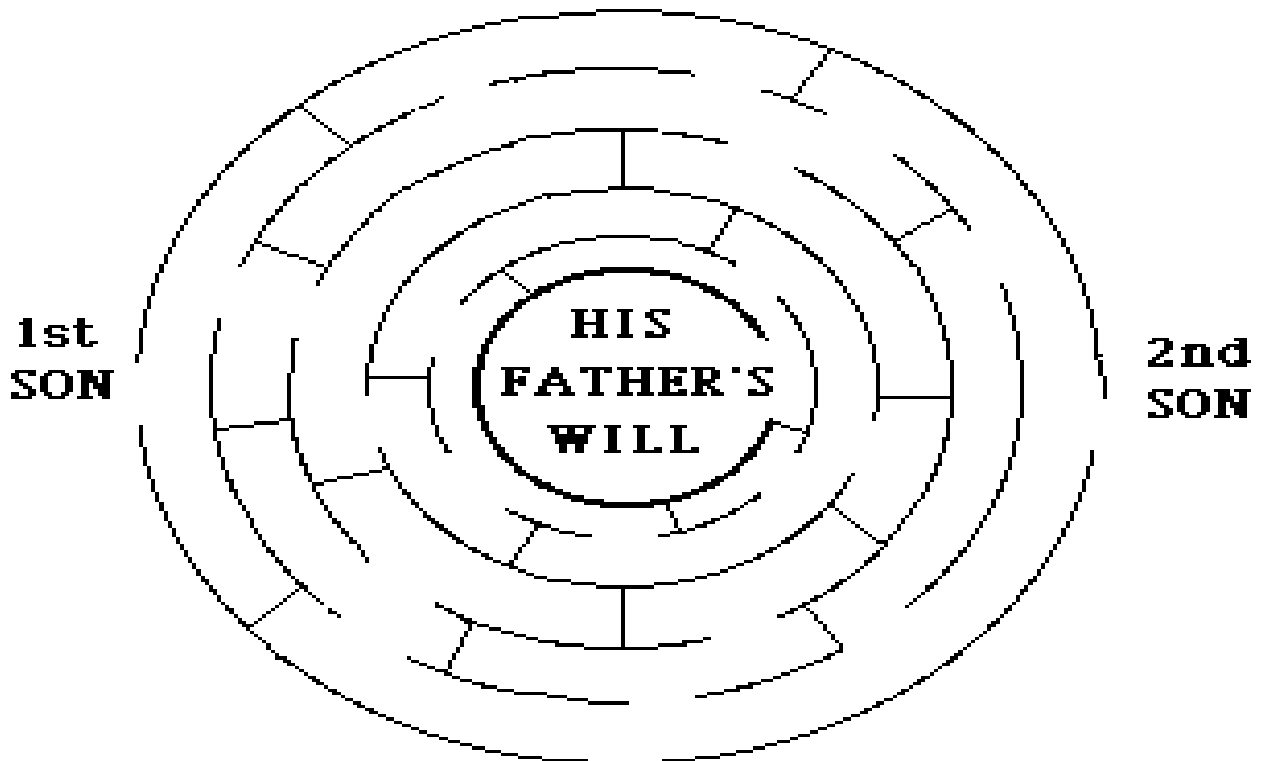

222. THE PARABLE OF THE TWO SONS (MATTHEW 21:28-32)

MEMORY VERSE:

"Children, obey your parents in all things, for this is well pleasing to the Lord."
COLOSSIANS 3:20

FILL IN THE BLANK:

1. "... A man had _____ sons..." MATTHEW 21:28

TRUE OR FALSE:

2. "...and he came to the first and said, 'Son, go, work today in my vineyard.'" MATTHEW 21:28
TRUE OR FALSE

FILL IN THE BLANK:

3. "He answered and said, 'I will not,' but afterward he regretted it and _____."
MATTHEW 21:29

TRUE OR FALSE:

4. "Then he came to the second and said likewise..." MATTHEW 21:30
TRUE OR FALSE

FILL IN THE BLANKS:

5. "... And he answered and said, 'I go, sir,' but he _____ go." MATTHEW 21:30

Jesus asked, "Which of the two did the will of his father?..."

UNDERLINE THE CORRECT ANSWER:

6. "...They said to Him, '____.'" MATTHEW 21:31
a. the first
b. the second

222. THE PARABLE OF THE TWO SONS

(MATTHEW 21:28-32)

M N B V Z T R W P L M N B V Z W D L
B C N J O H S O L M C E B N N F B G
N M J G M R W R G U C O W T Q A B L
L M V H I U N N T D W T R D D U F P
R R L B H W H V B G W G Y J L Z O W
B R M W E O D T T S R I F B F V B Z
B N I W P W R E P T U F D T H E C N
V G T P M B H H K K B E I S Y G B M
K H E B F H K T Q R E V D U D R V L
V V E K A D I S T H E J G H I S N P
W T H K T Y S H F M O P B M L W Y R
L P M H H E F F F O D J S N L E K W
W Q Z N E H Z C V Y T I A S I G J Z
M N K L R T R W K V O T S S W D R B
P L I A U B O D I A S B R H O R W M
T B R R B F C N H A O W H I C H S N
W D G B N M L P D Z B N M N T W Q B

FIND THE WORDS FROM THE SCRIPTURE BELOW IN THE PUZZLE ABOVE

"Which of the two did the will of his father?" They said to Him, 'The first.' " MATTHEW 21:31

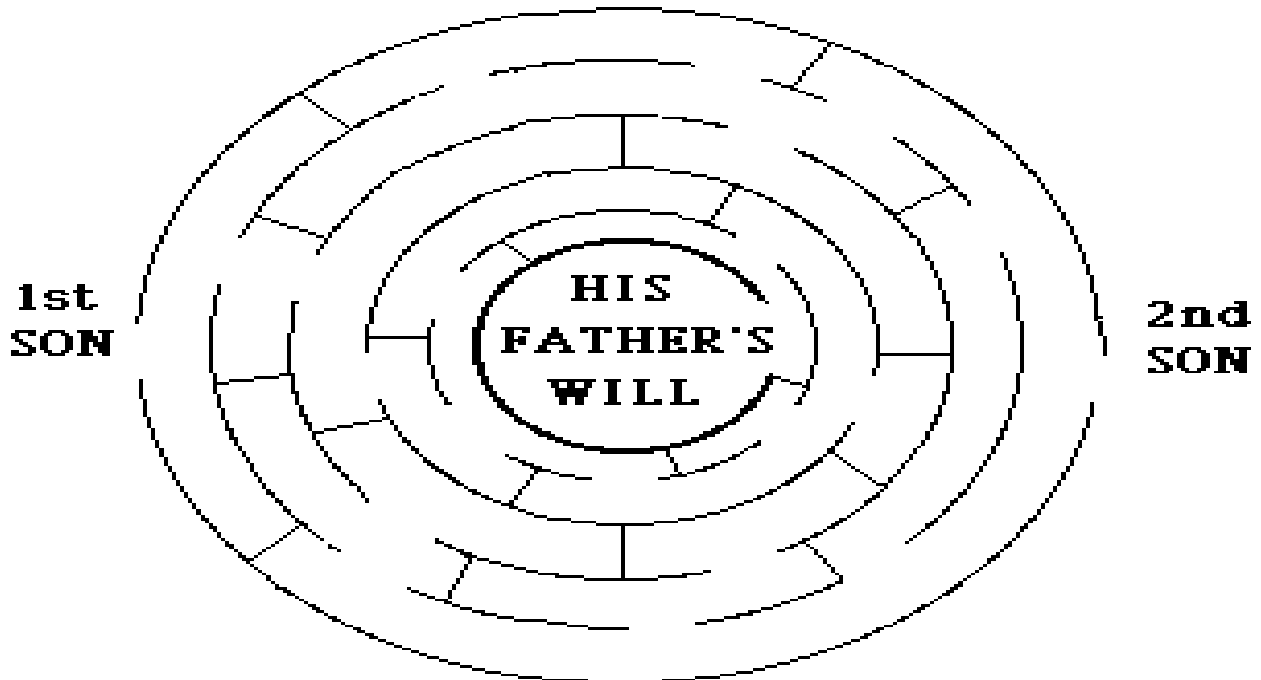

222. THE PARABLE OF THE TWO SONS (MATTHEW 21:28-32)

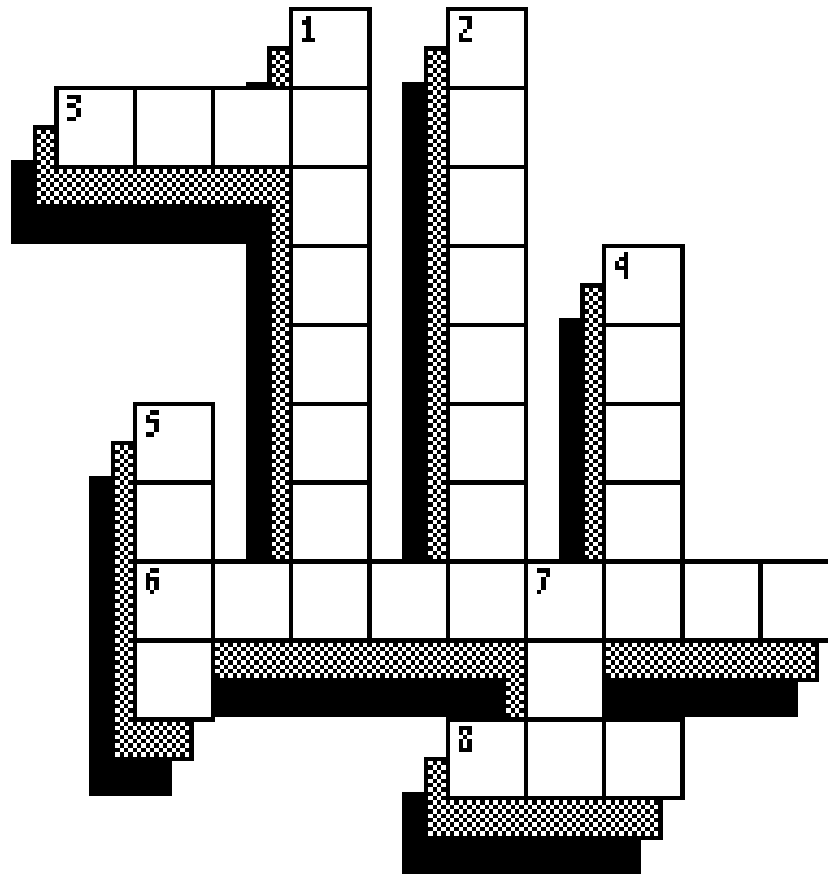

- 1 DOWN "Children, obey your parents in all things, for this is well _____ to the Lord." **COLOSSIANS 3:20**
- 7 DOWN "... A man had _____ sons..." **MATTHEW 21:28**
- 5 DOWN "...and he came to the first and said, 'Son, go, _____ today in my vineyard.'" **MATTHEW 21:28**
- 6 ACROSS "He answered and said, 'I will not,' but afterward he _____ it and went." **MATTHEW 21:29**
- 2 DOWN "Then he came to the second and said _____..." **MATTHEW 21:30**
- 8 ACROSS "... And he answered and said, 'I go, sir,' but he did _____ go." **MATTHEW 21:30**
- 3 ACROSS Jesus asked, "Which of the two did the _____ of his father?..." **MATTHEW 21:31**
- 4 DOWN "...They said to Him, 'The _____.'" **MATTHEW 21:31**

Bible Story 223

**PARABLE
OF THE
EVIL
VINEDRESSER**

Matthew 21:33-46

223. THE PARABLE OF THE EVIL VINEDRESSERS

(MATTHEW 21:33-46)



"But last of all he sent unto them his son, saying, They will reverence my son. But when the husbandmen saw the son, they said among themselves, This is the heir; come, let us kill him, and let us seize on his inheritance."

MATTHEW 21:37-38

223. THE PARABLE OF THE EVIL VINEDRESSERS

(MATTHEW 21:33-46)

MEMORY VERSE:

"Therefore I say to you, the kingdom of God will be taken from you and given to a nation bearing the fruits of it." MATTHEW 21:43

CIRCLE THE CORRECT WORD:

1. "... There was a certain landowner who planted a (TREE, VINEYARD) and set a hedge around it, dug a winepress in it and built a tower." MATTHEW 21:33

TRUE OR FALSE:

2. "Now when vintage-time drew near, he sent his servants to the vinedressers that they might receive its fruit." MATTHEW 21:34

TRUE OR FALSE

CIRCLE THE CORRECT WORDS:

3. "And the (VINEDRESSERS, ROBBERS) took his servants, beat one, killed one, and stoned another." MATTHEW 21:35
4. "Again he sent other servants, more than the first, and they did (DIFFERENTLY, LIKEWISE) to them." MATTHEW 21:36

TRUE OR FALSE:

5. "Then last of all he sent his son to them, saying, 'They will respect my son.' " MATTHEW 21:37
TRUE OR FALSE
6. ...when the vinedressers saw the son, they said among themselves, "This is the heir. Come let us welcome him and return his inheritance." MATTHEW 21:38
TRUE OR FALSE

CIRCLE THE CORRECT WORD:

7. "... they caught him, and cast him out of the vineyard, and (SALUTED, KILLED) him." MATTHEW 21:39

Jesus asked, "Therefore, when the owner of the vineyard comes, what will he do to those vinedressers?"

FILL IN THE BLANK:

8. "They said to Him, 'He will _____ those wicked men miserably, and lease his vineyard to other vinedressers who will render to him the fruits in their seasons.'" MATTHEW 21:41

223. THE PARABLE OF THE EVIL VINEDRESSERS

(MATTHEW 21:33-46)

C	H	Z	N	V	K	N	S	C	M	N	D	A	O	E
T	W	L	V	G	Y	H	Z	H	O	C	W	Z	L	C
F	V	M	N	B	I	E	G	I	D	J	T	T	S	B
O	V	O	O	O	N	V	T	P	G	B	Y	H	T	C
U	W	I	L	L	B	A	E	O	N	P	F	U	E	J
N	N	B	B	A	N	A	D	N	I	D	Z	J	R	T
Y	C	F	A	E	J	T	I	U	K	J	B	E	B	H
T	B	D	R	O	A	E	N	M	R	P	W	Q	Z	H
F	N	R	L	O	J	R	K	E	S	D	G	K	B	L
U	Z	I	O	H	M	H	I	T	K	Q	Z	O	T	Z
Y	Y	T	E	H	T	D	I	N	O	A	T	K	Y	R
F	O	C	D	B	G	U	W	J	G	A	T	V	O	L
Z	I	N	B	W	R	I	B	B	Z	N	T	H	U	P
M	A	B	Z	F	J	L	N	O	G	A	J	S	O	J
M	W	R	Z	B	V	Q	K	J	E	H	G	T	W	Z

FIND THE WORDS FROM THE SCRIPTURE BELOW IN THE PUZZLE ABOVE

"The kingdom of God will be taken from you and given to a nation bearing the fruits of it." MATTHEW 21:43

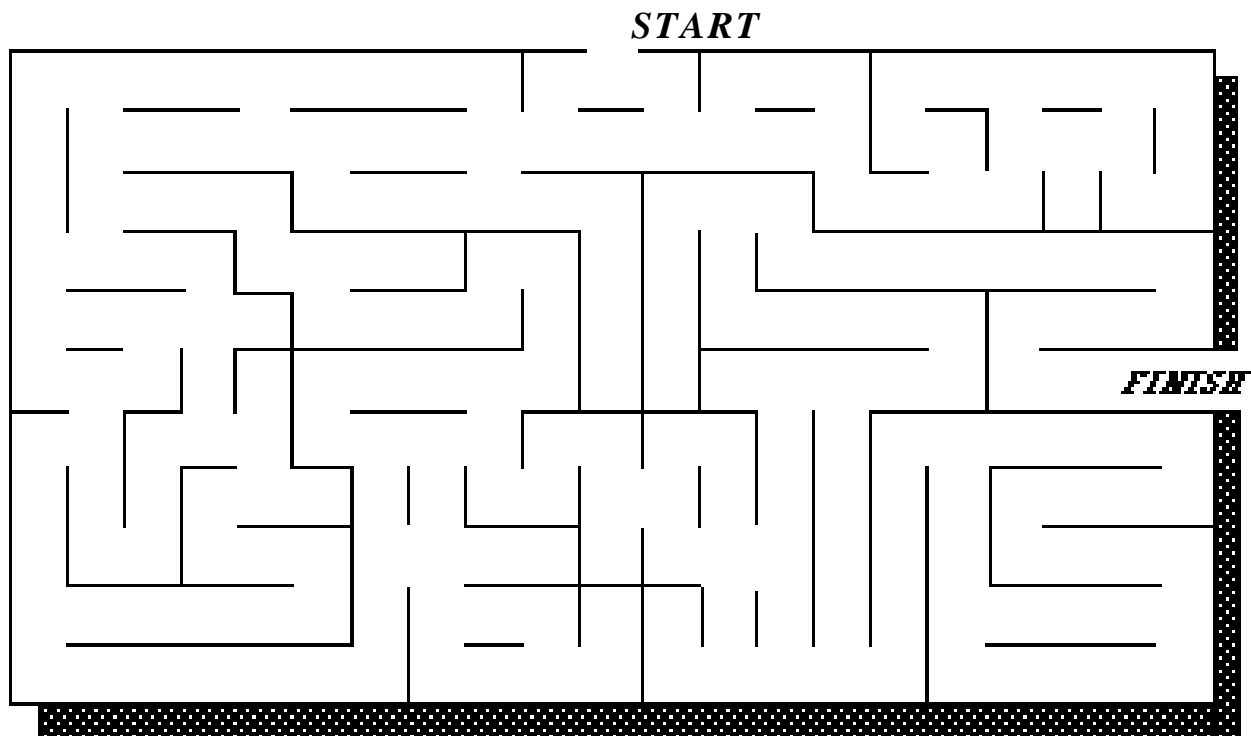

223. THE PARABLE OF THE EVIL VINEDRESSERS

(MATTHEW 21:33-46)

MEMORY VERSE:

"Therefore I say to you, the kingdom of God will be taken from you and given to a nation bearing the fruits of it." MATTHEW 21:43

UNDERLINE THE CORRECT ANSWER:

1. "... There was a certain landowner who..." MATTHEW 21:33
- planted a vineyard
 - set a hedge around it
 - dug a winepress in it
 - built a tower
 - all of the above

TRUE OR FALSE:

2. "Now when vintage-time drew near, he sent his servants to the vinedressers that they might receive its fruit." MATTHEW 21:34

TRUE OR FALSE

UNDERLINE ALL OF THE CORRECT ANSWERS:

3. "And the vinedressers..." MATTHEW 21:35
- beat one
 - welcomed the servants
 - sent the servant away
 - killed one
 - stoned another

TRUE OR FALSE:

4. "Then last of all he sent his son to them, saying, 'They will respect my son.'" MATTHEW 21:37

TRUE OR FALSE

5. "...when the vinedressers saw the son, they said among themselves, 'This is the heir. Come let us welcome him and return his inheritance.'" MATTHEW 21:38

TRUE OR FALSE

FILL IN THE BLANKS:

6. "... they caught him, and cast him out of the vineyard, and _____ him." MATTHEW 21:39

Jesus asked, "Therefore, when the owner of the vineyard comes, what will he do to those vinedressers?"

7. "They said to Him, 'He will _____ those wicked men miserably, and lease his vineyard to other vinedressers who will render to him the fruits in their seasons.'" MATTHEW 21:41

223. THE PARABLE OF THE EVIL VINEDRESSERS (MATTHEW 21:33-46)

T Z H B K G O O D R W O O H Z B V R E J W J A O K N P I J E
 G B U H B B J I Y T C A A O T M E L S D Z M N F P Q G B L J
 A C G F Z V U B M A W R Z G U M I V V F S U G L H I D J B G
 Z H I D B S B K D L O B H F I E K F B K W N I H I Y K R B E
 B J N D O S O G B S E T Q B R O A C J V R K F B D J L I J J
 E L T V R F Y L B B U F W R V Z D K P Y Z U H W D W Q Q W P
 K E M D B A D O Y J O W I T B O J B A R B V Y F I J I N B O
 A O L M B V A M E B U B Y F I J T D R H A W I K K B W S A B
 O O N V T S U L A D E A M Q V D B C B W H E B B T K B P S P
 A W T E C W Q T O R N N H P V E W E L M F M S E T F I G V D
 Y J H P R A C T I Q H A W Y O B C Z E Q A Y D N A S R O I I
 L A T T N O N J Y C B P N Z Y Y L K Q A D C L W H C R T Y K
 G G P I P W F T W B B M E I K J N B U L K K G Q R M D Q Q G
 H F N H O W L E F C F Y L N G T O V N G B S H K B F Z T F T
 I F C N J Z B H R G S H I Q O W I Q H O S G C L C O P L Q M
 J B B N W O C H U E G C Z V E H T W N F Q A G N I R A E B S
 W V F S I B E G I C H O J A N A A M H I P C Y B J S R P Q E
 E W O K L Y T J T C Q T D R U U N B E C J F Y R B B B W D K
 W Q V Y L A O J S B V G Y F Z I P R J T G B U R Y E Y K J I
 I T M L K A O U Y T H D K R P C I T P T Z I U Z R B I V O G
 Z C T E T W W H M E K J B I H W I A L E J D V E R N G P H I
 Z Y N N Z V P T F J P D F J S Q W M B A D P P E G J N S R O
 T N F O D Z O R R M W O Z T P A E M C P D I S D N G G L L Z
 F K W H E Z O V F H G F M N I R H Q B C P F O R E D B R Y K
 Y K Y M E M Y F Z O Q W S W J R T S G G S M W R G Q B E J Z
 D W F Z D M V O I P V D W E Y W F R S G V A A V I B V R J F
 O I E D C M Z P D D Y U E Y V Y S S Z R D M K B B K A Y C A
 W J D C C M Y U U E H I N H M M R F Z B S M B J R A J B O T
 S Q R V L I S U B B W R O N T I N C L S U P S S V U A P H U
 R L L E G B S R L K N T U U B D C Q C N B T V S I T O V S U

FIND THE WORDS FROM THE SCRIPTURE BELOW IN THE PUZZLE ABOVE

"Therefore I say to you, the kingdom of God shall be taken from you and given to a nation bearing the fruits of it." MATTHEW 21:43

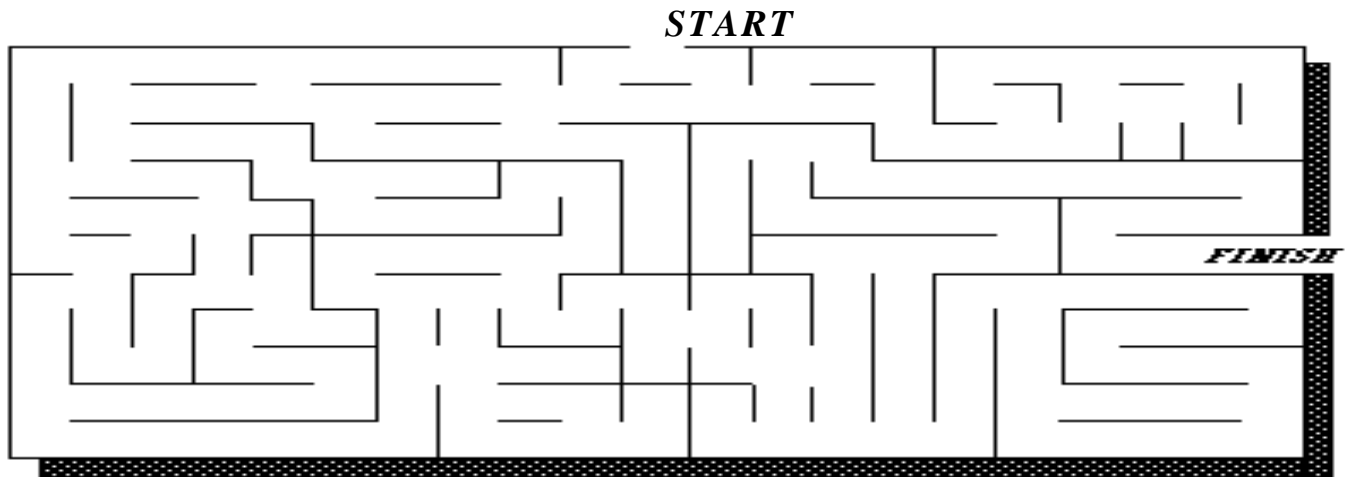

223. THE PARABLE OF THE EVIL VINEDRESSERS (MATTHEW 21:33-46)

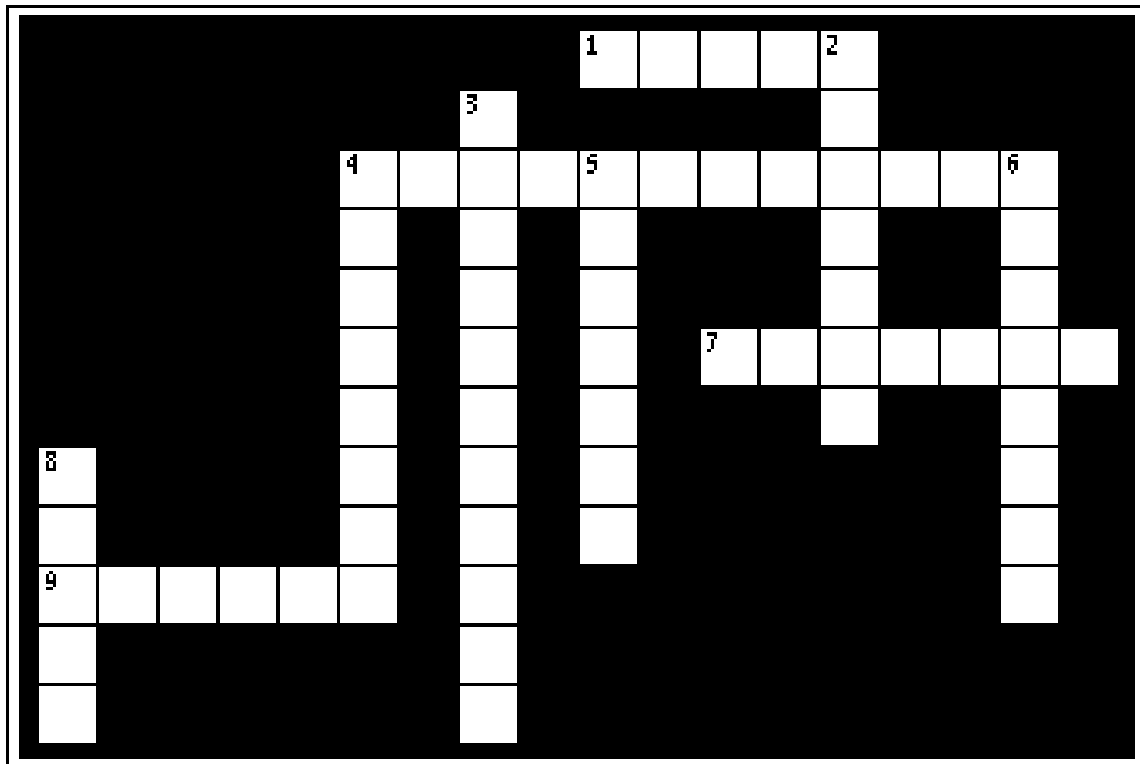

- 4 DOWN "... There was a certain landowner who planted a _____ and set a hedge around it, dug a winepress in it and built a tower." **MATTHEW 21:33**
- 7 ACROSS "Now when vintage-time drew near, he sent his servants to the vinedressers that they might _____ its fruit." **MATTHEW 21:34**
- 4 ACROSS "And the _____ took his servants, beat one, killed one, and stoned another." **MATTHEW 21:35**
- 6 DOWN "Again he sent other _____, more than the first, and they did likewise to them." **MATTHEW 21:36**
- 2 DOWN "Then last of all he sent his son to them, saying, 'They will _____ my son.'" **MATTHEW 21:37**
- 3 DOWN "...when the vinedressers saw the son, they said among themselves, 'This is the heir. Come let us kill him and seize his _____.'" **MATTHEW 21:38**
- 9 ACROSS "... they caught him, and cast him out of the vineyard, and _____ him." **MATTHEW 21:39**
- 1 ACROSS Jesus asked, "Therefore, when the _____ of the vineyard comes, what will he do to those vinedressers?" **MATTHEW 21:39**
- 5 DOWN "They said to Him, 'He will _____ those wicked men miserably, and lease his vineyard to other vinedressers who will render to him the fruits in their seasons.'" **MATTHEW 21:41**
- 8 DOWN "Therefore I say to you, the kingdom of God will be _____ from you and given to a nation bearing the fruits of it." **MATTHEW 21:43**

Bible Story 224

**THE
GREAT
COMMANDMENT**

Mark 12:28-34



"A scribe asked Jesus, 'Which is the first commandment of all?' "
Mark 12:28-34

224. THE GREAT COMMANDMENT

(MARK 12:28-34)

MEMORY VERSE:

"And to love Him with all the heart, with all the understanding, with all the soul, and with all the strength. And to love one's neighbor as oneself, is more than all the whole burnt offerings and sacrifices." MARK 12:33

"Then one of the scribes came, and having heard them reasoning together, perceiving that He had answered them well, asked Him, 'Which is the first commandment of all?' "
MARK 12:28

FILL IN THE BLANKS:

1. "Jesus answered him, 'The first of all the commandments is: Hear, O Israel, the LORD our _____, the LORD is _____.'" MARK 12:29

CIRCLE THE CORRECT WORDS:

2. " 'And you shall love the LORD your God...' MARK 12:30
with all your (HEART, HEAD),
and with all your (SOUL, SWORD),
with all your (MIND, TIME),
and with all your (STRENGTH, WEAKNESS).'
This is the first commandment."

TRUE OR FALSE:

3. "And the second, like it, is this: 'You shall love your neighbor as yourself.'..." MARK 12:31
TRUE OR FALSE
4. ...There are other commandments greater than these. MARK 12:31
TRUE OR FALSE

FILL IN THE BLANK:

5. "So the scribe said to Him, 'Well said, Teacher. You have spoken the _____, ...'" MARK 12:32

CIRCLE THE CORRECT WORDS:

6. "So when Jesus saw that he answered (FOOLISHLY, WISELY), He said to him, 'You are not far from the kingdom of God.'" MARK 12:34
7. "And after that (NO ONE, EVERYONE) dared question Him." MARK 12:34

224. THE GREAT COMMANDMENT

(MARK 12:28-34)

N Y W D V B E Z J T T G U R H
E Z L R B W A G B N P S J B L
I M O C O B T I O E D Z R Z Z
G M R B A K E K J M Q T Q I R
H H D R O Y H W R D A T B U F
B W Z Y H N D B O N F L R O L
O V L N O B O N Z A A J U W P
R V M V S U G B G M H E V O J
T N O N T J R C E M D V H E S
U C H O R J D S C O W O S C Z
N K E L E G I H E C Y L T U Z
Y N A O N J L P J L F G O C U
T Z R B G V D N I M F A L J P
F Y T Z T N Q U B D Z Z S T F
U I B Z H H S M P J W T T H Q

COMMANDMENT
GOD
LORD
MIND
SOUL
YOURSELF

FIRST
HEART
LOVE
NEIGHBOR
STRENGTH

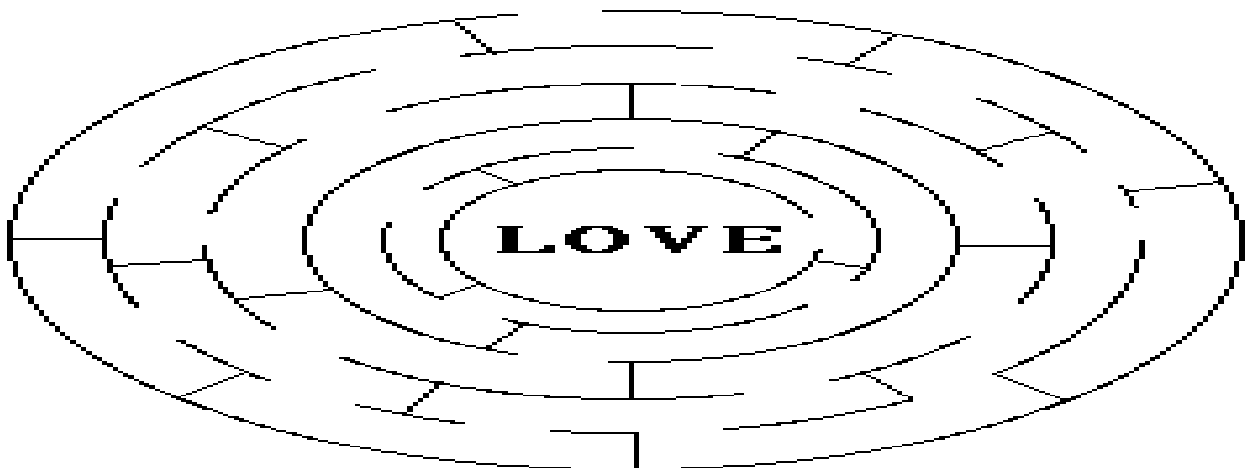

224. THE GREAT COMMANDMENT

(MARK 12:28-34)

MEMORY VERSE:

"And to love Him with all the heart, with all the understanding, with all the soul, and with all the strength. And to love one's neighbor as oneself, is more than all the whole burnt offerings and sacrifices." MARK 12:33

"Then one of the scribes came, and having heard them reasoning together, perceiving that He had answered them well, asked Him, 'Which is the first commandment of all?' "
MARK 12:28

FILL IN THE BLANKS:

1. "Jesus answered him, 'The first of all the commandments is: Hear, O Israel, the LORD our _____, the LORD is _____.'" **MARK 12:29**
2. "'And you shall love the LORD your God..." **MARK 12:30**
with all your _____,
and with all your _____,
with all your _____,
and with all your _____.'
This is the first commandment."

TRUE OR FALSE:

3. "And the second, like it, is this: 'You shall love your neighbor as yourself.'..." **MARK 12:31**
TRUE OR FALSE
4. "...There are other commandments greater than these. **MARK 12:31**
TRUE OR FALSE

FILL IN THE BLANKS:

5. "So the scribe said to Him, 'Well said, Teacher. You have spoken the _____, ...'" **MARK 12:32**
6. "So when Jesus saw that he answered _____, He said to him, 'You are not far from the kingdom of God.'" **MARK 12:34**
7. "And after that _____ _____ dared question Him." **MARK 12:34**

224. THE GREAT COMMANDMENT

(MARK 12:28-34)

M E Y Z C G K D L P G L L L H S J P H C C C F F G F I P S M
 N D F W F B C V Z C B I C Z O B G L R F N Z G O B N U W R V
 F P G Y T V P D D A W Z F B U G P K K V G R J N I V F R H Z
 B L S S U H T G N E R T S I C E B N L L A H S T D G R M Z A
 D T Y O F L E S R U O Y S P L Q N D B V S K Q U T E G O W V
 R V U H U S R S N I A K Y V R A Z E T I O V N Y N D B D Q G
 O O K D B S H U O U B K A U I O R N W V H B N G M O K D I D
 L Z D S T J K W H J B T G H M S E G E V V G S S A G Y I X N
 D W G W L D K T L E B S V K Z M B S B Y J O G R H J S E L E
 I I A P J C J B H C C R U D D J J M L S S A L Z D C G U C I
 W D S N Q E H Z A W P I R N A C B E P L P M P C Y I N T M G
 F P V B Q B F G E K I F A A O B M Y H Q Q A T V D R L V D H
 I T G O L U R Y N Y U M N M G I Y Q Q K B A B H P N C B H A B
 U E W Z W E Y B T E M Y M O O Q Q Q B M J R E F D E B H Q O
 F F L K A R L W F O E A F Q H B F S I B B I O B O V A S Z R
 W E S T P G P D C J N Y Q G N O B Y C F F H B N O J L A Y W
 H M E L L G Z W B D W F P J N Q O U R B Y C N I Y B I Q D Z
 T R R Z P S G G M C D H U Y J W N V W V L J A S A L U Y P S
 H A R B B S E E L V N K T S G E I Q Z C O B W B U L W J G W
 M Z G H C K N R M K E B M T L Y R T Z K J C Z O Y L M O Q H
 Z A Z B N T X V T R A E H C D V T B K P I Y S M Q S D G H C
 L R E A B Q R M B Y T A W T K L U G N S E V O L W N J L B R
 H R F H E D J Y E V W E Z A Z K Q M W I G C B I Y B D P R Y
 G W O Q W N R K O M L W F B Z S P V R R D F N Q F B B J C E
 O B L W G R U Y B U M Z M I N F H O D W H I H Y S S R I K V
 H Q I Y V R O L U F I L K Y Q H H I S K P Z F M Y T J I B A
 Y Q F I I P Y A M J N K F W P B F T E C Z F S P B P E C E F
 C B B B J M B T H A D L U A M M F Q A H A S P S F Y Z B A B
 W M H I J C Y M J H M L E Q O P E Q W K G T N B Y Y G K G E
 E G L B B A J P M B N V E Q Q G Q K N L C G K T Q Q C K T V

COMMANDMENT
 GOD
 LORD
 NEIGHBOR
 STRENGTH
 YOU

COMMANDMENT
 GREATER
 LOVE
 SHALL
 YOURSELF

FIRST
 HEART
 MIND
 SOUL
 YOUR

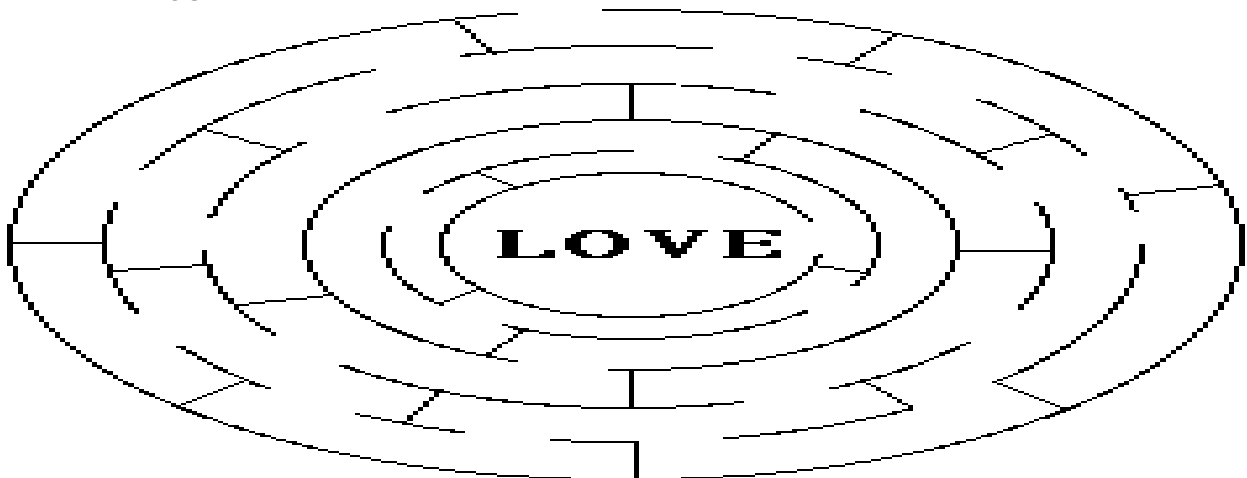

224. THE GREAT COMMANDMENT

(MARK 12:28-34)

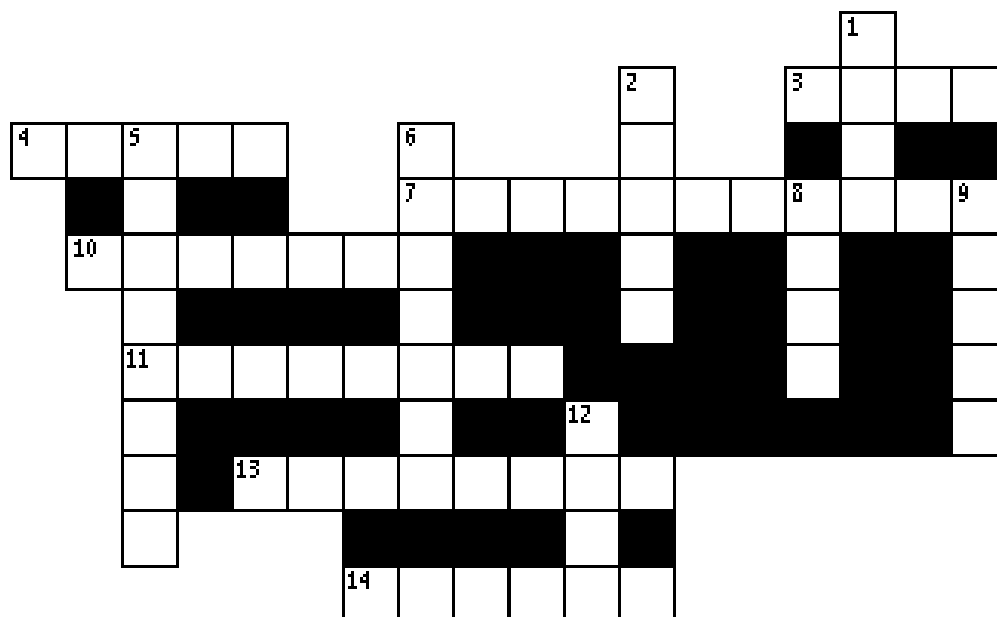

- 6 DOWN "Then one of the _____ came, and having heard them reasoning together, perceiving that He had answered them well, asked Him, 'Which is the first commandment of all?' " **MARK 12:28**
- 4 ACROSS " _____ answered him, 'The first of all the commandments is: Hear, O Israel, the LORD our God, the LORD is one.' " **MARK 12:29**
- 1 DOWN " 'And you shall _____ the LORD your God...' " **MARK 12:30**
- 2 DOWN "...with all your _____,..." **MARK 12:30**
- 12 DOWN "...and with all your _____,..." **MARK 12:30**
- 8 DOWN "...with all your _____,..." **MARK 12:30**
- 5 DOWN "...and with all your _____..." **MARK 12:30**
- 7 ACROSS "...This is the first _____."
- 11 ACROSS "And the second, like it, is this: 'You shall love your _____ as yourself.'..." **MARK 12:31**
- 10 ACROSS "There is no other commandment _____ than these." **MARK 12:31**
- 9 DOWN "So the scribe said to Him, 'Well said, Teacher. You have spoken the _____,...' " **MARK 12:32**
- 3 ACROSS "...And to love one's neighbor as oneself, is _____ than all the whole burnt offerings and sacrifices." **MARK 12:33**
- 14 ACROSS "So when Jesus saw that he answered _____, He said to him, 'You are not far from the kingdom of God.' " **MARK 12:34**
- 13 ACROSS "And after that no one dared _____ Him." **MARK 12:34**

Bible Story 225

THE WIDOW'S MITE

LUKE 21:1-4



"Jesus said, 'Truly I say to you that this poor widow has put in more than all.'" *Luke 21:1-4*

225. THE WIDOW'S MITE

(LUKE 21:1-4)

MEMORY VERSE:

"So let each one give as he purposes in his heart, not grudgingly or of necessity; for God loves a cheerful giver." 2 CORINTHIANS 9:7

TRUE OR FALSE:

1. "...Then He looked up and saw the rich putting their gifts into the treasury." **LUKE 21:1**
TRUE OR FALSE

CIRCLE THE THE CORRECT WORD:

2. "He saw also a certain poor widow putting in two (MICE, MITES)." **LUKE 21:2**

TRUE OR FALSE:

3. So He said, "Truly I say to you that this poor widow has put in less than all." **LUKE 21:3**
TRUE OR FALSE

4. "...for all these out of their abundance have put in offerings for God..." **LUKE 21:4**
TRUE OR FALSE

CIRCLE THE THE CORRECT WORD:

5. "...but she out of her poverty has put in (ALL, NONE) the livelihood that she had." **LUKE 21:4**

225. THE WIDOW'S MITE

(LUKE 21:1-4)

F A Y N L N O J D Y M D B Q B
T D T C M O A J I L J J Z K Z
N B B B O L O G L U B I W K B
B D U N B T H A T R O P G V O
T A L L D O H J Q T J N Z H W
I L Y W R B B V T W R T A B E
T V Y Z I Z W N U B H D T H C
L G Z O C D B H P I O Q T T T
K L M Y U Z O E S E Z A J O U
W J M S B H K W R N B F G L C
Q C A N I A Y O S B E A A T J
I Y H I R S M A Z B C H Z O T
E T W P O O R T G H J D T S H
Q B V W N V N E I P B W U T H
G N V Z V B B H K U P Y J R L

FIND THE WORDS FROM THE SCRIPTURE BELOW IN THE PUZZLE ABOVE

"Truly I say to you that this poor widow has put in more than all."

LUKE 21:3

BEGINNING

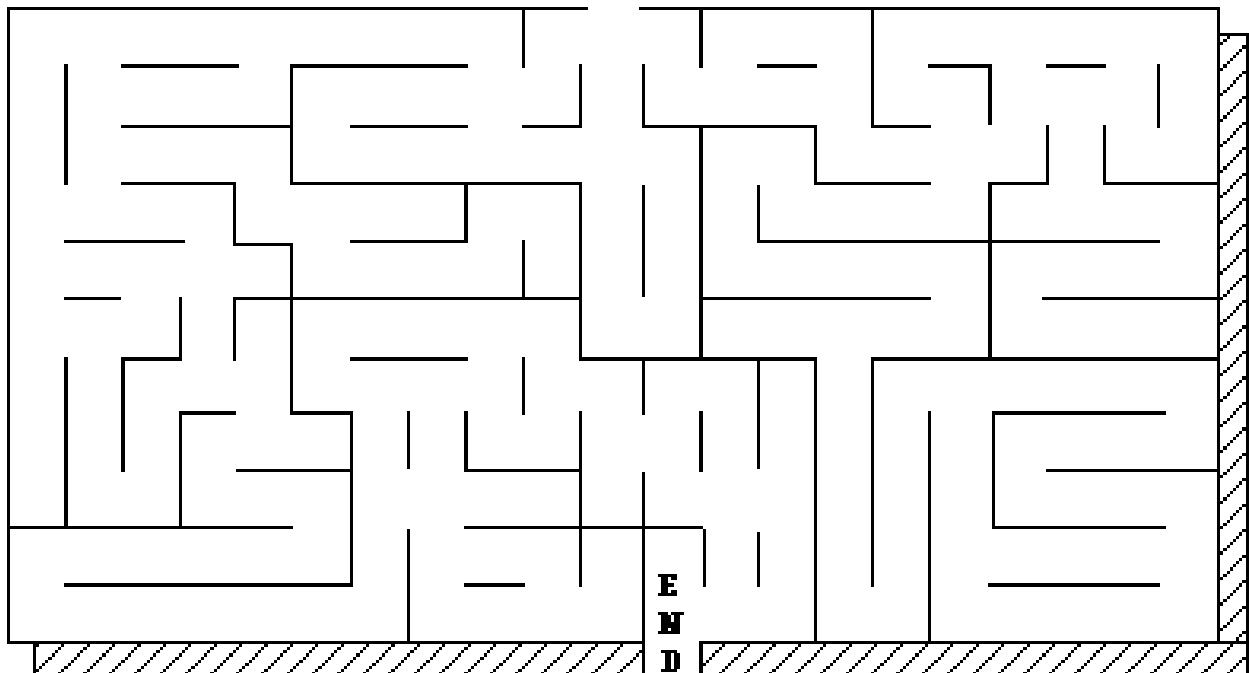

225. THE WIDOW'S MITE

(LUKE 21:1-4)

MEMORY VERSE:

"So let each one give as he purposes in his heart, not grudgingly or of necessity; for God loves a cheerful giver." 2 CORINTHIANS 9:7

TRUE OR FALSE:

1. "...Then He looked up and saw the rich putting their gifts into the treasury." **LUKE 21:1**
TRUE OR FALSE

FILL IN THE BLANK:

2. "He saw also a certain poor widow putting in two _____." **LUKE 21:2**

TRUE OR FALSE:

3. So He said, "Truly I say to you that this poor widow has put in less than all." **LUKE 21:3**
TRUE OR FALSE
4. "...for all these out of their abundance have put in offerings for God..." **LUKE 21:4**
TRUE OR FALSE

FILL IN THE BLANK:

5. "...but she out of her poverty has put in _____ the livelihood that she had." **LUKE 21:4**

225. THE WIDOW'S MITE

(LUKE 21:1-4)

G B B R N M B M G M N B R P T N T B
 N M F A Y N L N O J D Y M D B Q B N
 L M T D T C M O A J I L J J Z K Z M
 B N N B B B O L O G L U B I W K B M
 T M B D U N B T H A T R O P G V O R
 R B T A L L D O H J Q T J N Z H W P
 R W I L Y W R B B V T W R T A B E L
 P W T V Y Z I Z W N U B H D T H C Z
 L V L G Z O C D B H P I O Q T T T V
 Z Z K L M Y U Z O E S E Z A J O U B
 M B W J M S B H K W R N B F G L C B
 P T Q C A N I A Y O S B E A A T J N
 L L I Y H I R S M A Z B C H Z O T M
 R W E T W P O O R T G H J D T S H M
 B B Q B V W N V N E I P B W U T H R
 P L G N V Z V B B H K U P Y J R L T
 B N M G R W S Z Q W T H P L M N B P

FIND THE WORDS FROM THE SCRIPTURE BELOW IN THE PUZZLE ABOVE

"Truly I say to you that this poor widow has put in more than all."

LUKE 21:3

BEGINNING

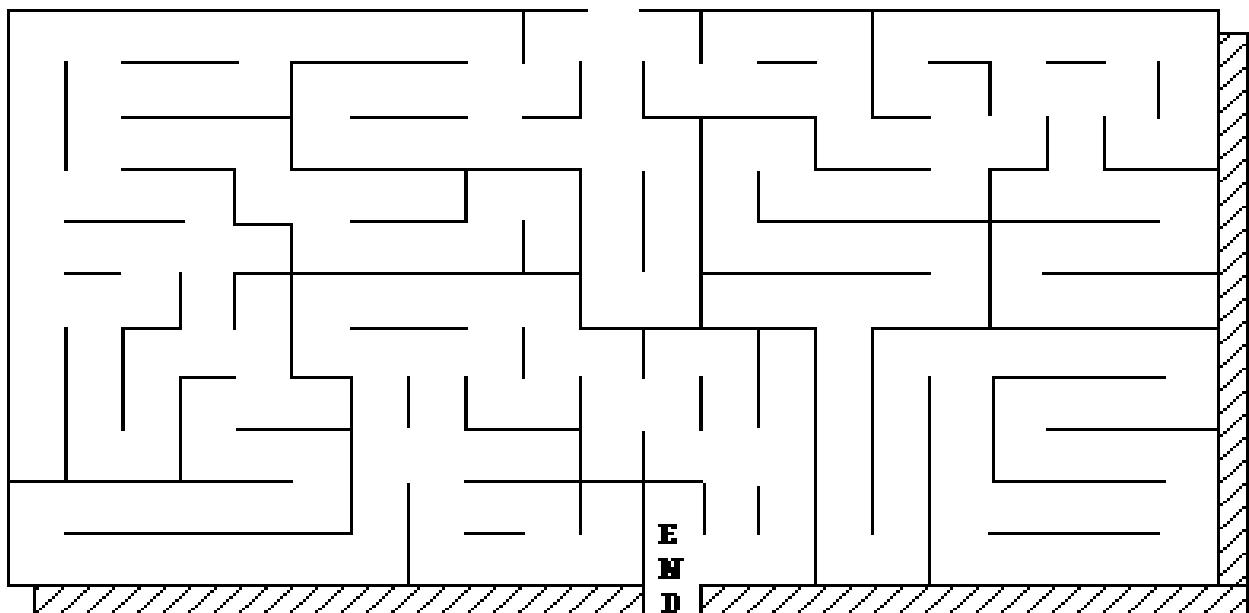

225. THE WIDOW'S MITE

(LUKE 21:1-4)

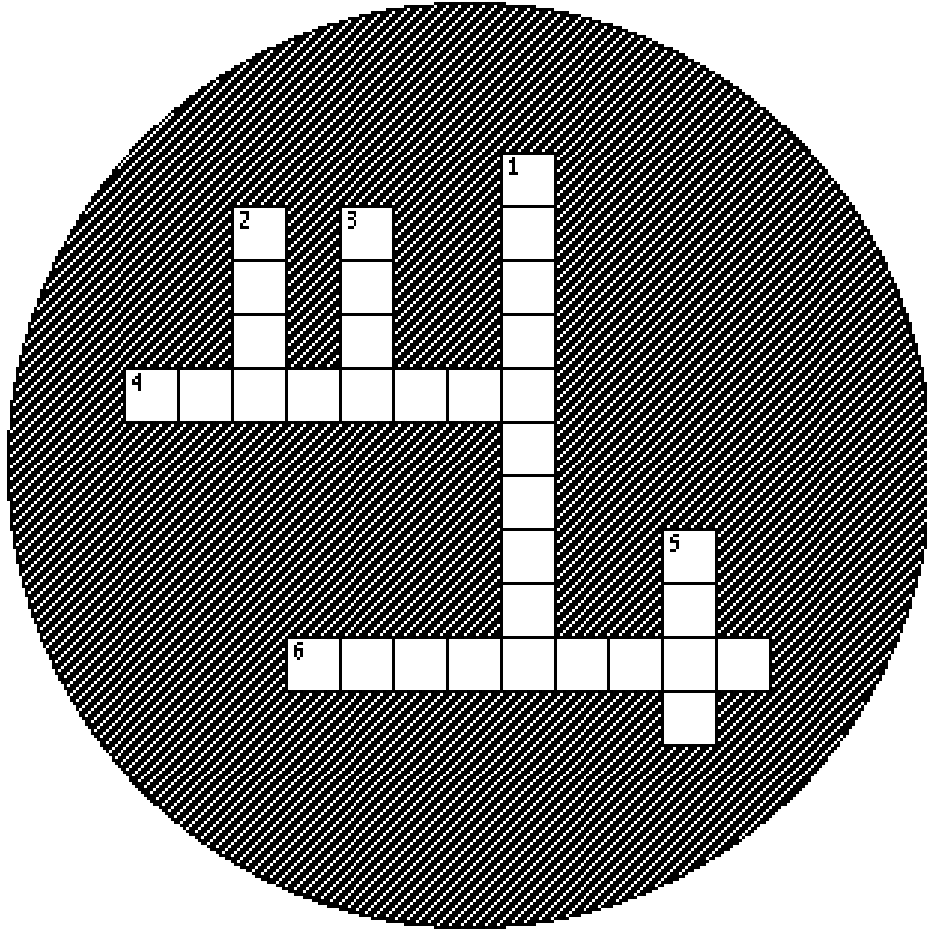

- 4 ACROSS "So let each one give as he purposes in his heart, not grudgingly or of necessity; for God loves a _____ giver." **2 CORINTHIANS 9:7**
- 5 DOWN "...Then He looked up and saw the _____ putting their gifts into the treasury." **LUKE 21:1**
- 3 DOWN "He saw also a certain _____ widow putting in two mites." **LUKE 21:2**
- 2 DOWN "So He said, 'Truly I say to you that this poor widow has put in _____ than all.'" **LUKE 21:3**
- 6 ACROSS "...for all these out of their _____ have put in offerings for God..." **LUKE 21:4**
- 1 DOWN "...but she out of her poverty has put in all the _____ that she had." **LUKE 21:4**

Bible Story 226

**SIGNS,
END OF THE
AGE & THE
TRIBULATION**

Matthew 24:3-28



"Jesus told of His disciples about the signs of His comings
and the end of the age." *Matthew 24:3-28*

226. SIGNS, END OF THE AGE, & THE TRIBULATION

(MATTHEW 24:3-28)

MEMORY VERSE:

"But he who endures to the end shall be saved." MATTHEW 24:13

"Now as He sat on the Mount of Olives, the disciples came to Him privately, saying, 'Tell us, when will these things be? And what will be the sign of Your coming, and the end of the age?'" MATTHEW 24:3

TRUE OR FALSE:

1. "And Jesus answered and said to them: 'Take heed that no one deceives you.' "
MATTHEW 24:4
TRUE OR FALSE
2. "For many will come in My name, saying 'I am the Christ,' and will deceive many."
MATTHEW 24:5
TRUE OR FALSE

CIRCLE THE CORRECT WORDS:

3. "But he who endures to the end shall be (**SAVED, LOST**)."
MATTHEW 24:13
4. "And this gospel of the kingdom will be preached in all the nations, and then the (**BEGINNING, END**) will come."
MATTHEW 24:14

TRUE OR FALSE:

"Therefore when you see the 'abomination of desolation,' spoken of by Daniel the prophet, standing in the holy place..."

5. "then let those who are in Judea flee to the mountains."
MATTHEW 24:16
TRUE OR FALSE
6. "Let him who is on the housetop not come down to take anything out of his house."
MATTHEW 24:17
TRUE OR FALSE
7. And let him who is in the field go back to get his clothes.
MATTHEW 24:18
TRUE OR FALSE

CIRCLE THE CORRECT WORD:

8. "For as (**WIND, LIGHTNING**) comes from the east and flashes to the west, so also will the coming of the Son of Man be."
MATTHEW 24:27

226. SIGNS, END OF THE AGE, & THE TRIBULATION (MATTHEW 24:3-28)

L	J	Y	Z	V	M	T	T	K	X	P	N	R	C	K
Q	U	G	E	F	S	C	N	I	V	L	Y	V	E	E
S	T	N	B	H	Z	H	T	Z	E	M	C	Q	B	W
D	H	O	P	U	W	Q	V	A	N	D	M	M	R	M
R	C	H	G	B	I	I	F	K	D	R	R	L	N	K
N	H	S	B	T	B	W	Y	W	U	M	C	I	Q	K
W	P	O	B	B	V	T	I	B	R	P	B	N	T	W
C	S	T	A	Z	S	L	Q	D	E	Z	C	H	S	Y
Z	U	P	U	H	B	J	O	T	S	S	E	I	P	B
I	S	W	W	E	B	D	Y	B	A	H	F	C	Z	U
S	K	N	Z	C	W	U	P	V	B	S	E	V	W	T
Y	H	M	F	H	E	J	E	R	J	T	B	H	B	E
Q	L	A	D	R	H	D	S	H	R	N	O	S	K	R
B	C	W	L	N	R	U	U	Z	K	V	Q	J	E	J
B	Z	O	W	L	E	H	B	E	B	H	Q	P	V	J

FIND THE WORDS OF THE SCRIPTURE BELOW IN THE PUZZLE ABOVE

***"But he who endures to the end shall be saved."* MATTHEW 24:13**

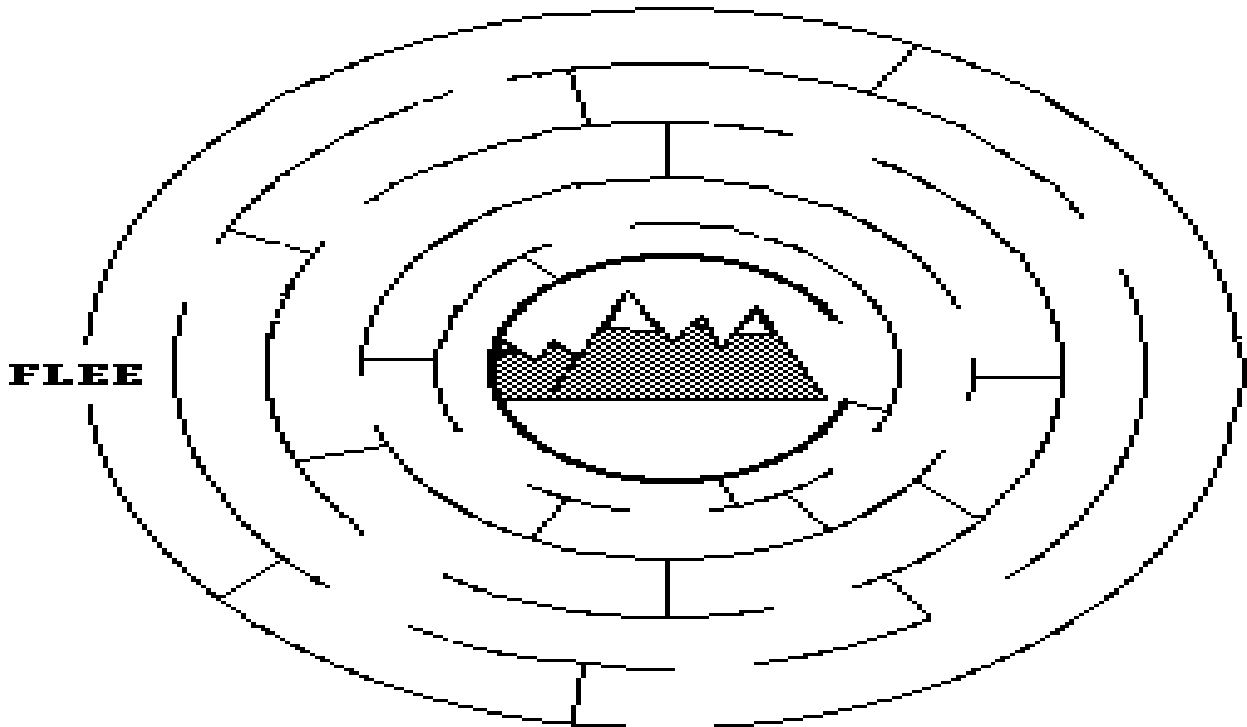

226. SIGNS, END OF THE AGE, & THE TRIBULATION

(MATTHEW 24:3-28)

MEMORY VERSE:

"But he who endures to the end shall be saved." MATTHEW 24:13

"Now as He sat on the Mount of Olives, the disciples came to Him privately, saying, 'Tell us, when will these things be? And what will be the sign of Your coming, and the end of the age?'" MATTHEW 24:3

TRUE OR FALSE:

1. "For many will come in My name, saying 'I am the Christ,' and will deceive many."
MATTHEW 24:5

TRUE OR FALSE

MATCHING:

2. Match the phrases in the left hand column with the correct one in the right hand column:

___ nation (24:7)	a. will rise up and deceive many
___ many false prophets (24:11)	b. will rise against nation
___ lawlessness (24:12)	c. will be preached in all the world as a witness
___ the love of many (24:12)	d. will grow cold
___ the gospel of the kingdom (24:14)	e. will abound

TRUE OR FALSE:

"Therefore when you see the 'abomination of desolation,' spoken of by Daniel the prophet, standing in the holy place,"

3. "Let him who is on the housetop not come down to take anything out of his house."
MATTHEW 24:17

TRUE OR FALSE

4. And let him who is in the field go back to get his clothes. MATTHEW 24:18
TRUE OR FALSE

5. "For as lightning comes from the east and flashes to the west, so also will the coming of the Son of Man be." MATTHEW 24:27

TRUE OR FALSE

226. SIGNS, END OF THE AGE, & THE TRIBULATION (MATTHEW 24:3-28)

M Z V D K Y N H K K B R A B H K E V K N N E H B Y T O H B Z
 N Y N Q W C Q R S E B R G P I W B D U B V N Q O V Q C K R H
 G E F I B M S N Q I S V T D Q Q J V Q B Q Q P J L O F M Z R
 L G H W D R P N V S E Y I T K B P T I K D S O I M S D H A V
 Q N U T B C Z Z Z I L B O V L G W J M N A F B B O U G L E Q
 S O B L R B B Y R R T D Y P Z E W B A O N F B E M M V B M P
 D H T J H R R Z D E U D M T M N C P T C E B U G V Z Y T N R
 R S B D Z F E K R B D I X D M D B L T H V E H B Z Y N C C Y
 N O G U B E V B C N J N W P N I N B H Z T H S V Y H J A I P
 W T H J V B K G N P I B S U R L Y P E M E I E W C W K P P U
 C P E U B Q E Z Y V I F N T F W K Z W T N G B H E V K P M I
 Z W C H J Q W L I W U N S Q A S I R L F Y M F W N N A M H Q
 I N R T R R B K R W G J I L E H M B B N L D Z Q T K D H M R
 Y M M N K V K J P N Z M M Y F Y I D U C A Z S I E W E W E K
 Q W S T P Q K P H D E P M I Q K T O Z X N N Q B V X H M G C
 M O Z V L M W N B F G Y Z G X E J G U Y Z S G F E U A D N V
 B Z W F M L Y N Y A M K K Q X R D U R Q S I H U L D S A H T
 J E I Y D I E F D W S W J I L Q C U G A Q V C L Y Y Q E E H
 U R R I R N R J K A O Y Y G P K N R V R C W B N E Q T N F E
 T P V Q F I J N S M K E S J U K U E D F P P Q Y C S U P C I
 H G S Y P C J K E S T U B D Z V D W G V W C Z V V D D T S J
 C E B K Z V G E H S A A D W N B A G H K R P S J Q G O Y N S
 H U N S H S O W N H S N N W U J G G U G A Y M A J O M Q Z U
 P B W D S J H U J A E L H Y Q P M L B P B Z I G W N S Q H D
 S A W U U P G K Y L C O D H V U F N F W W O C I U H B Y M S
 U U H F T R B T G L J B Q S I V V K S Y M C U I B Q Q C D Z
 S W R K N C E P U L U Y W M Z U S Y R T U U J F J H Y G E Y
 K Z T I V E R S B B D E J K S M J B Z Y T W Y A N A T O W H
 L F C Z H B O W E G W B T Y L V I E B Q Y O K S E J N F E K
 C W H A N R M Z I J S R U O C S B B W Q E R N F T B V B Z G

FIND THE WORDS OF THIS SCRIPTURE BELOW IN THE WORDSEARCH ABOVE

"But he who endures to the end shall be saved." MATTHEW 24:13

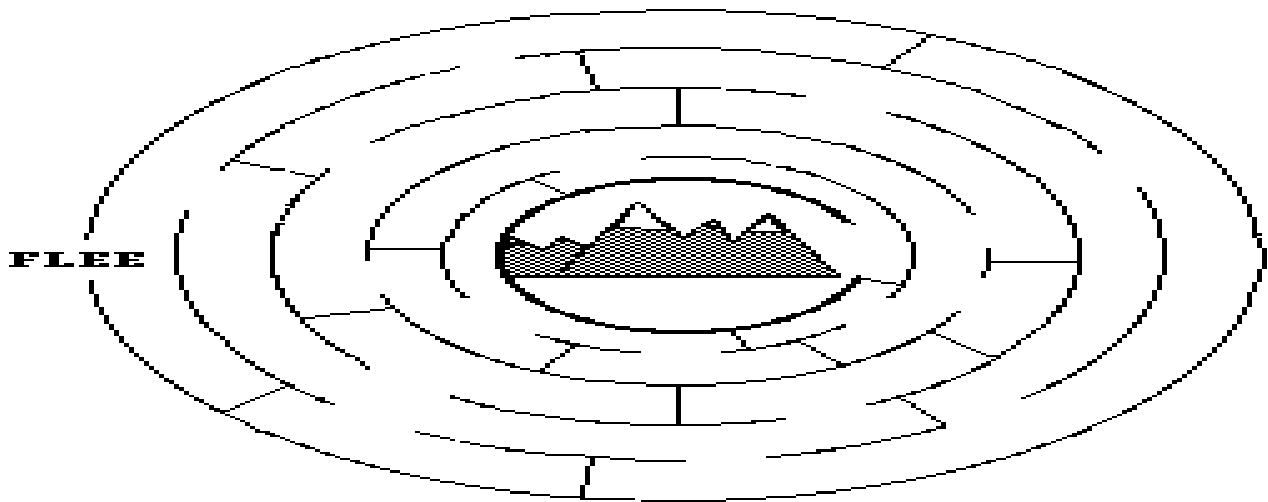

226. SIGNS, END OF THE AGE, & THE TRIBULATION (MATTHEW 24:3-28)

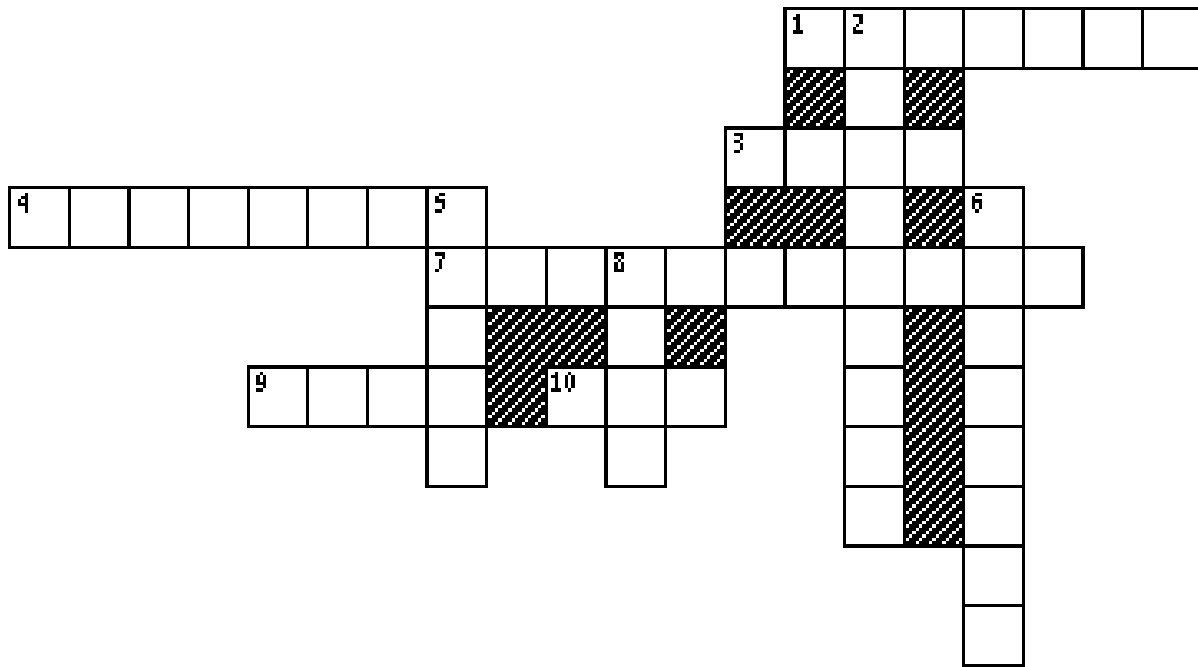

- 3 ACROSS "Now as He sat on the Mount of Olives, the disciples came to Him privately, saying, 'Tell us, when will these things be? And what will be the _____ of Your coming, and the end of the age?' " **MATTHEW 24:3**
- 4 ACROSS "And Jesus answered and said to them: 'Take heed that no one _____ you.'" **MATTHEW 24:4**
- 8 DOWN "For _____ will come in My name, saying 'I am the Christ,' and will deceive many." **MATTHEW 24:5**
- 5 DOWN "But he who endures to the end shall be _____." **MATTHEW 24:13**
- 10 ACROSS "And this gospel of the kingdom will be preached in all the nations, and then the _____ will come." **MATTHEW 24:14**
- 7 ACROSS "Therefore when you see the '_____ of desolation,' spoken of by Daniel the prophet, standing in the holy place..." **MATTHEW 24:15**
- 9 ACROSS "...then let those who are in Judea _____ to the mountains." **MATTHEW 24:16**
- 6 DOWN "Let him who is on the _____ not come down to take anything out of his house." **MATTHEW 24:17**
- 1 ACROSS "And let him who is in the field not go back to get his _____." **MATTHEW 24:18**
- 2 DOWN "For as _____ comes from the east and flashes to the west, so also will the coming of the Son of Man be." **MATTHEW 24:27**

Bible Story 227

THE SECOND COMING

Matthew 24:27-31

227. THE SECOND COMING (MATTHEW 24:27-31)



"And he shall send his angels with a great sound of a trumpet, and they shall gather together his elect from the four winds, from one end of heaven to the other."

MATTHEW 24:31

227. THE SECOND COMING

(MATTHEW 24:27-31)

MEMORY VERSE:

"For as the lightning comes from the east and flashes to the west, so also will the coming of the Son of Man be." MATTHEW 24:27

CIRCLE THE CORRECT WORD:

1. "For as the ___ comes from the east and flashes to the west, so also will the coming of the Son of Man be." MATTHEW 24:27
FIRE LIGHTNING

TRUE OR FALSE:

2. "Immediately after the tribulation of those days the sun will be darkened..." MATTHEW 24:29
TRUE OR FALSE
3. "...and the moon will not give its light..." MATTHEW 24:29
TRUE OR FALSE
4. ...the stars will stay in heaven... MATTHEW 24:29
TRUE OR FALSE
5. "...and the powers of heaven will be shaken." MATTHEW 24:29
TRUE OR FALSE

CIRCLE THE CORRECT WORDS:

6. "...and they will see the Son of Man coming on the (CLOUDS, STARS) of heaven with power and great glory." MATTHEW 24:30
7. "And He will send His angels with a great sound of a (TUBA, TRUMPET)..." MATTHEW 24:31
8. "...and they will gather together His elect from the four (WINDS, COUNTRIES), from one end of heaven to the other." MATTHEW 24:31

227. THE SECOND COMING

(MATTHEW 24:27-31)

E D B Z G I C M T Q G B S U F
Z V B C P P C O M E S S S S H R
I N L L C N B B O D W Y O I C
I P A W V R U O F Y T N E W T
D Y E C N M A T T H E W E P G
Z G G A S E P P J O D M Z K E
P N N Z E O V R Q O K W E S T
Z W I E H S N E L K A F R R O
V Y N A S C R O S P G E P E W
U Z T S A N E Y F Y V L E N J
D U H T L P M R P M T K U A V
W G G S F C H E V Z A N V I H
E F I C O M I N G S S N E P Y
E Y L D U B Y B G T A I F W G
B I M O R F Y V Y V U Q I Q T

COMES
COMING
EAST
FLASHES
FROM
LIGHTNING

MATTHEW
SON OF MAN
TWENTY FOUR
TWENTY SEVEN
VERSE
WEST

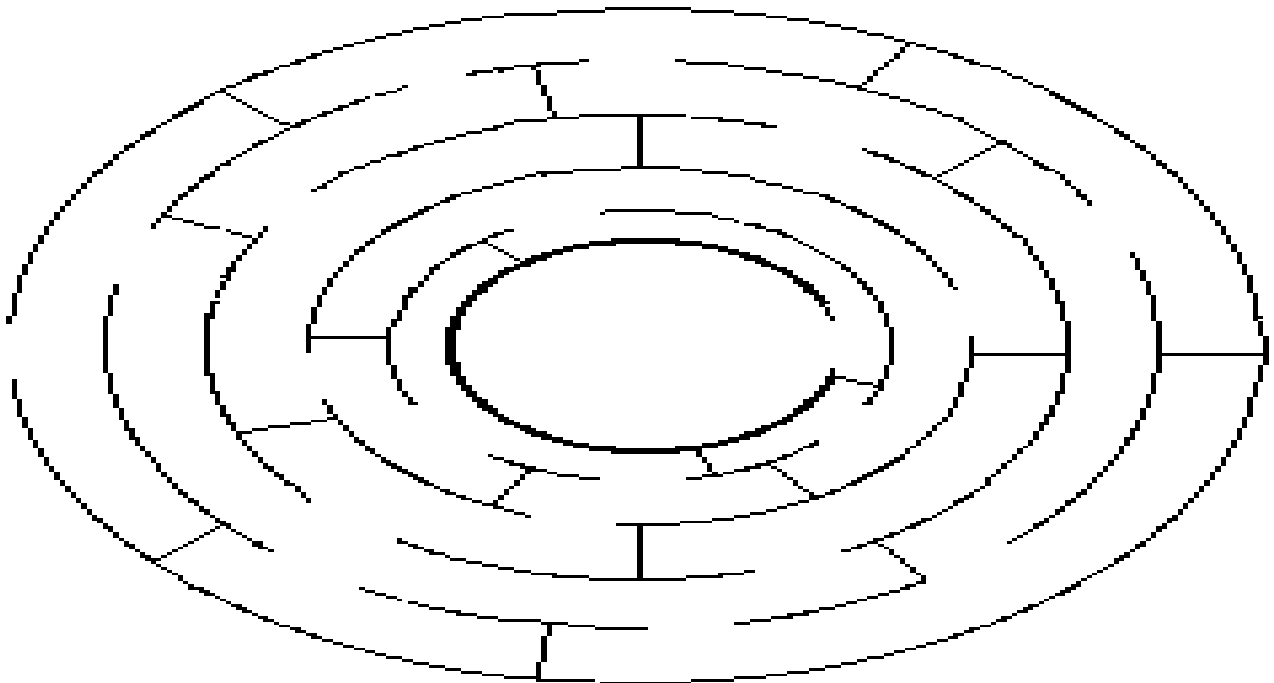

227. THE SECOND COMING

(MATTHEW 24:27-31)

MEMORY VERSE:

"For as the lightning comes from the east and flashes to the west, so also will the coming of the Son of Man be." MATTHEW 24:27

FILL IN THE BLANK:

1. "For as the _____ comes from the east and flashes to the west, so also will the coming of the Son of Man be." **MATTHEW 24:27**

TRUE OR FALSE:

2. "Immediately after the tribulation of those days the sun will be darkened..." **MATTHEW 24:29**
TRUE OR FALSE
3. "...and the moon will not give its light..." **MATTHEW 24:29**
TRUE OR FALSE
4. ...the stars will stay in heaven... **MATTHEW 24:29**
TRUE OR FALSE
5. "...and the powers of heaven will be shaken." **MATTHEW 24:29**
TRUE OR FALSE

FILL IN THE BLANKS:

6. "...and they will see the Son of Man coming on the _____ of heaven with power and great glory." **MATTHEW 24:30**
7. "And He will send His angels with a great sound of a _____..." **MATTHEW 24:31**
8. "...and they will gather together His elect from the four _____, from one end of heaven to the other." **MATTHEW 24:31**

227. THE SECOND COMING (MATTHEW 24:27-31)

Z I I R N J K H L U Y W S P E M Z R B N E W C V Y B A P I Y
 E B Q F I J E N G D E J M U R I R G Y V E O U J E U M O R F
 B V Y P C G W J J W B T K Z Q T B D Q Q N R J A C D V P P P
 P S K Z V O U Y B S R U Y N K J D G R D Q H Y G V E D M M U
 G B S H S H K G B R A B O U K D O H T A S Q K I R Y H W H I
 U B B S J G P K S R G P H Q V C G B W N F P N S Q Q A M M Q
 B W F T P B W E E V T D I V B N B F E E F O E I J S S D E R
 A H B N C R Z I L Y I T Q I J B B F N V B B B F W D Q A G K
 U R I T E O K K T B O V K Z P A R S T T E K O A B G T E N C
 W T S V B M S E U D Y P L S U G W R Y E H U J S B O U N H V
 Z E Z H R H Q I D D M T Z L V M G Z S N I H I F J N D P E I
 W C A N N R V S J I B D M C B F G W E Y G S B Y N H M Y B J
 F H K Y Q N Z I I N W P M B M V L N V L M E E V E Q S M C S
 W Q W C S N R R I B S B T W V S N B E A D B G L T H A Q S B
 V I B M P Z D E U F N T S Q S J K B N N Z F B M T T B Q N D
 F W D R Z Y R B G N S Q A B E I Y K F Z N Z V O T A Q Y Z S
 H T B C B Z C N Z J I L E G S E M O C Q T S W H Q J Y C H L
 U L R B K K N P E M M Y N E B B B N V W S Q E M O B T G M I
 X J H C E B Y V G P M I K N J V B O E C I W H V S O N O D G
 T D Z F V G I W M Y Z G F D P D B N B P V G W Z B C V F E H
 B U B E K Z R W S B B Q A I W V T C G W W H Q Y M F H F W T
 G J V B E L P N O W J I E L W Y U H P R P C I C Z D L B E N
 H U B Q W K H D K Y Y G F S F T Q Z W A C B B E Y A K B Z I
 E H J Q B J B F T E S J O O C J I M Y B P Q F N S G M R Z N
 C T R R K P Y A A U B N U W B B L T T W Y Z U H H V H Z H G
 R B B V K N D W S A O R Q S R P B F Y M Z S E T W Y L A R Z
 M T P Q W N K A E F D D B O N L U N O U O S L E V N B E V Y
 S V L M Y F S M M N N W F H Y B Z S Q T C M N V N J T M Q H
 Z F M L E J E A C L D Y B Y K P L G N I M O C E K K C N P K
 W Y D I R N N S J B Q H L K I A U C Q Y U I Y L W K A C R G

ALSO
 COMES
 COMING
 EAST
 FLASHES
 FOR
 FROM

LIGHTNING
 MATTHEW
 SON OF MAN
 TWENTY FOUR
 TWENTY SEVEN
 VERSE
 WEST

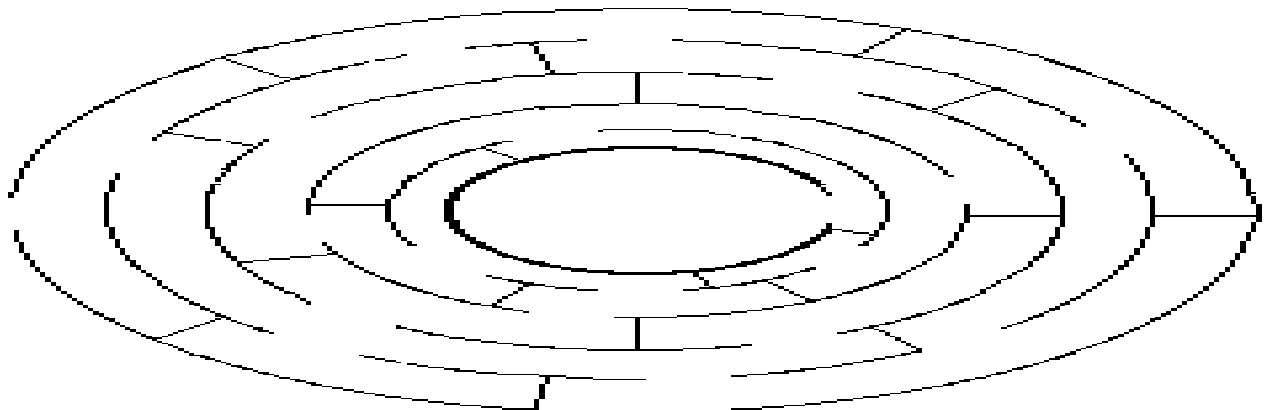

227. THE SECOND COMING (MATTHEW 24:27-31)

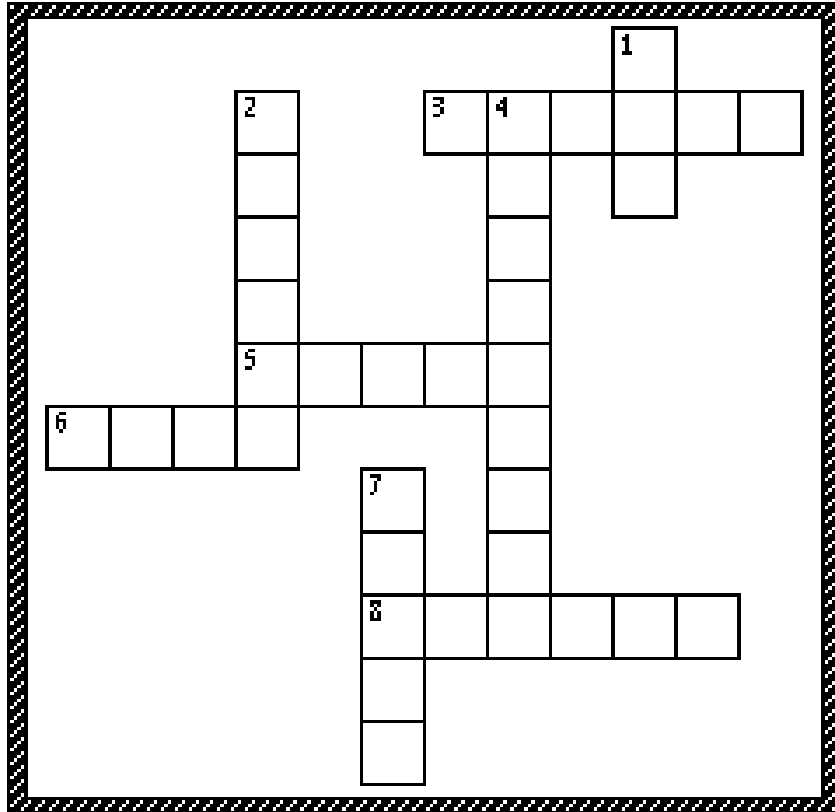

- 4 DOWN "For as the ___ comes from the east and flashes to the west, so also will the coming of the Son of Man be." **MATTHEW 24:27**
- 1 DOWN "Immediately after the tribulation of those days the _____ will be darkened..." **MATTHEW 24:29**
- 6 ACROSS "...and the _____ will not give its light..." **MATTHEW 24:29**
- 7 DOWN "...the _____ will fall from heaven..." **MATTHEW 24:29**
- 2 DOWN "...and the powers of heaven will be _____." **MATTHEW 24:29**
- 3 ACROSS "...and they will see the Son of Man coming on the _____ of heaven with power and great glory." **MATTHEW 24:30**
- 8 ACROSS "And He will send His _____ with a great sound of a trumpet..." **MATTHEW 24:31**
- 5 ACROSS "...and they will gather together His _____ from the four winds, from one end of heaven to the other." **MATTHEW 24:31**

Bible Story 228

**THE
PARABLE
OF THE
TEN MAIDENS**

MATTHEW 25:1-13



"Jesus tells a parable about ten maidens."
Matthew 25:1-13

228. THE PARABLE OF THE TEN MAIDENS

(MATTHEW 25:1-13)

MEMORY VERSE:

"Watch therefore, for you know neither the day nor the hour in which the Son of Man is coming." MATTHEW 25:13

TRUE OR FALSE:

1. "Then the kingdom of heaven shall be likened to ten virgins who took their lamps and went out to meet the bridegroom." MATTHEW 25:1
TRUE OR FALSE

FILL IN THE BLANKS:

2. "Now five of them were _____, and five were _____." MATTHEW 25:2

CIRCLE THE CORRECT WORDS:

3. "Those who were foolish took their lamps and took (**MUCH, NO**) oil with them..." MATTHEW 25:3
4. "...but the wise took oil in their vessels with their (**LAMPS, BROOMS**)." MATTHEW 25:4

TRUE OR FALSE:

5. "But while the bridegroom was delayed, they all slumbered and slept." MATT. 25:5
TRUE OR FALSE
6. And at noontime a cry was heard, "Behold, the bridegroom is coming; go out to meet him!"
MATTHEW 25:6
TRUE OR FALSE

CIRCLE THE CORRECT WORDS:

7. "...the foolish said to the wise, 'Give us some of your (**MATCHES, OIL**), for our lamps are going out.'" MATTHEW 25:8
8. "But the wise answered, saying, '(**YES, NO**), lest there should not be enough for us and you...'" MATTHEW 25:9
9. "...the bridegroom came, those who were ready went in with him to the wedding; and the door was (**SHUT, OPEN**)." MATTHEW 25:10
10. "Afterward, the other virgins came also, saying, 'Lord, Lord, open to us!' But he answered and said, 'Assuredly, I say to you, I (**DO, DO NOT**) know you.'" MATTHEW 25:11-12

228. THE PARABLE OF THE TEN MAIDENS

(MATTHEW 25:1-13)

J T B R J Y A S W M R J L F V
 G E N O P F Z L I O L Y L H D
 N H K Z D Z T T S O P C V O H
 E D C G Q W U O E R J T C C Q
 V T R I M M E D O G Z G B H B
 A I H K A G J L W E Z U O D K
 E L M E I Z Q S E D U U A B Q
 H Q P A F N K T C I R Y B S I
 J S U P I T G R B R P B S M J
 V Z M J A D K D C B F B P E G
 N G J B H T E B O H Q T M Z P
 G N I D D E W N J M N G A B C
 H I B F O O L I S H B B L O T
 E K O P D J V Z T L Q G B E Q
 A W J D W G H U H Z C A N B I

BRIDEGROOM
 DAY
 FOOLISH
 HEAVEN
 HOUR

KINGDOM
 LAMPS
 MAIDENS
 OIL

TEN
 TRIMMED
 WEDDING
 WISE

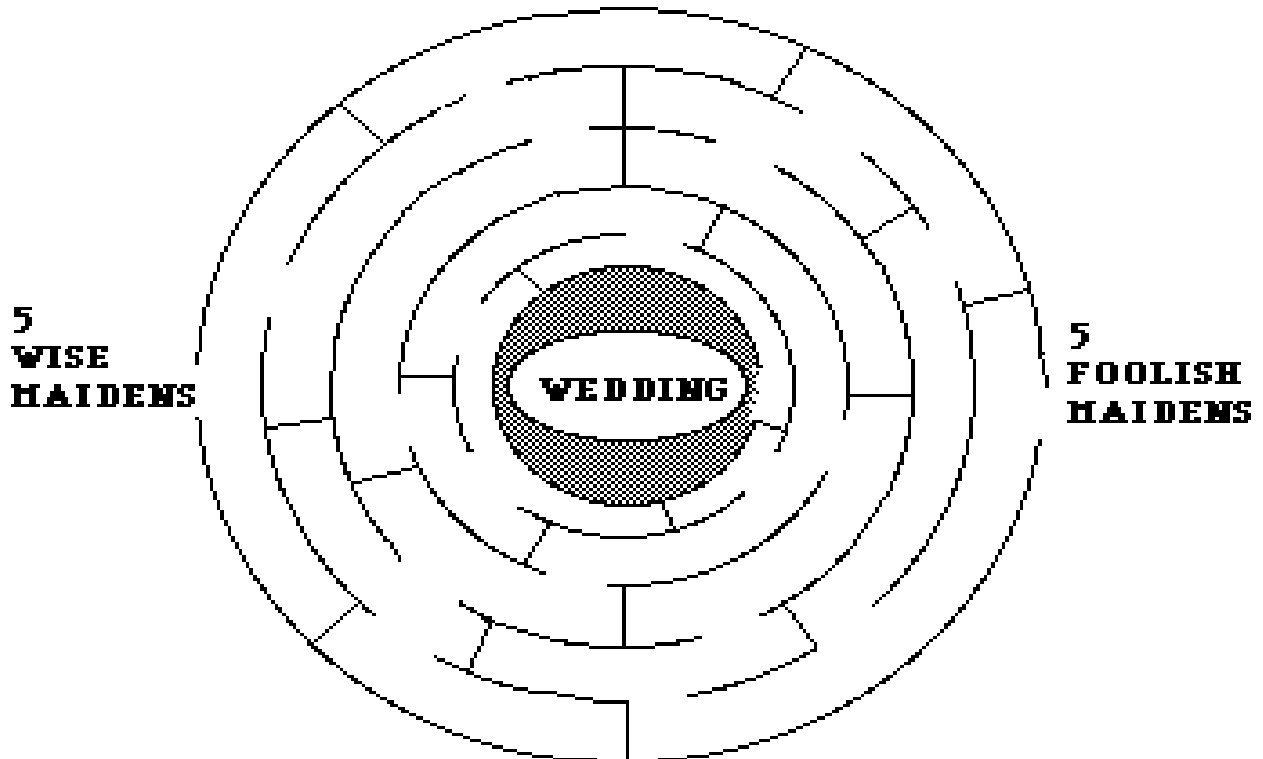

228. THE PARABLE OF THE TEN MAIDENS

(MATTHEW 25:1-13)

MEMORY VERSE:

"Watch therefore, for you know neither the day nor the hour in which the Son of Man is coming." MATTHEW 25:13

TRUE OR FALSE:

1. "Then the kingdom of heaven shall be likened to ten virgins who took their lamps and went out to meet the bridegroom." **MATTHEW 25:1**
TRUE OR FALSE

FILL IN THE BLANKS:

2. "Now five of them were _____, and five were _____." **MATTHEW 25:2**
3. "Those who were foolish took their lamps and took _____ oil with them..." **MATTHEW 25:3**
4. "...but the wise took oil in their vessels with their _____." **MATTHEW 25:4**

TRUE OR FALSE:

5. "But while the bridegroom was delayed, they all slumbered and slept." **MATTHEW. 25:5**
TRUE OR FALSE
6. And at noontime a cry was heard, "Behold, the bridegroom is coming; go out to meet him!"
MATTHEW 25:6
TRUE OR FALSE

FILL IN THE BLANKS:

7. "...the foolish said to the wise, 'Give us some of your _____, for our lamps are going out.'" **MATTHEW 25:8**
8. "But the wise answered, saying, ' _____, lest there should not be enough for us and you...'" **MATTHEW 25:9**
9. "...the bridegroom came, those who were ready went in with him to the wedding; and the door was _____." **MATTHEW 25:10**

CIRCLE THE CORRECT ANSWER:

10. "Afterward, the other virgins came also, saying, 'Lord, Lord, open to us!' But he answered and said, 'Assuredly, I say to you, I (**DO, DO NOT**) know you.'" **MATTHEW 25:11-12**

228. THE PARABLE OF THE TEN MAIDENS

(MATTHEW 25:1-13)

R O O T D Z S B K B B E T Q R B J W C J V R N I H H I D J J
 M A O M D B S B G X R U W W T I D Y K P Y Z B F B I Y K R W
 F Y W L V O F O L Y Q U B I F V E M B A R K B H W D J L I B
 Q L J N D R A Y O E C E A Y Q V B I D R H A V Y F D W Q Q A
 M G A T M B V D M A O H N M P O Y D C X W H W I B B J I N S
 L H G H V B S A L O C Y P H Y Y J V E L M F E B B T B W S V
 U I F T P T W U T I A B M W Z K T E Z E Q A M S E T B B P I
 Z J F P T C A Q T D G B Y N I G W I K Q A D Y D N A F I G Y
 R W B N I N W C J R C F H E N O H K B U L K C L W H S R O Q Q
 L E V M H P W N T Y U S C L Q E A A V N G B K G Q R C R T F
 T W W C O O Z L H W C O G I V N U D Q H I Q S H K B M D Q Q Q
 W I Q B N O O B H Y B Q H Z A U I J W N C P G C L C F Z T Q Q
 L Z T F N J R C G M T V D J B Z H T B H T J B Y B J O P L D
 B Z C O S T B G J R E H J Y F P S B B E T Z F B R B S R P J
 I T Y V K Z A E E F J K D K R H I W R J W J B B K Y B B W O
 B F N M Y D W O J D L P O B I S L C T P E E N A M F O N O S
 F Y B T L E V W H Z I A F F J P O L A L A D D P Z R J Y V H
 G D K F N H V P V I M R M Z N J O P M U P D D D E B G G P R
 S O W W O E E Y F D H W B P W Y F I M B T P P S I E D M S L
 W W I Y S E Z A O B O G W M S V C I Q K B R I W R N A N L Y
 B S J S H D Z V V K P Q D S E M W W S G G S I A R I G G R J
 T R E F M C M O K E D V U W Y B Q F R S G V F M D G Q B E J
 G L Q E Z C I I P L N Y I N N B S S S Z R D M E M I B B R C
 S Z L D D L N Z U R E H B O U M P R F Z B S N K V E K V B H
 A B H R C G M Y U T B W T U Z M M N C L S S M B B B D A P S
 Z C U L D L M S R A K N O H U E A C Q C N U P S J R A J V E
 B H G O V G I S D L W O E G I O L R E J W B T V S V U A J J
 E J M B E G B O Y S B A A S R Z A L S D Z J A O S I T O L G
 K L I H B B O I M B W R Z F I O R V V F S M N F B N P I B E
 A E N F B V J B D J O B H B V W R F B B W U G L P Q G B B J

BRIDEGROOM
 DAY
 FOOLISH
 HEAVEN
 HOUR

KINGDOM
 LAMPS
 LAMPS
 MAIDENS
 OIL

SON OF MAN
 TRIMMED
 VESSELS
 WEDDING
 WISE



228. THE PARABLE OF THE TEN MAIDENS

(MATTHEW 25:1-13)

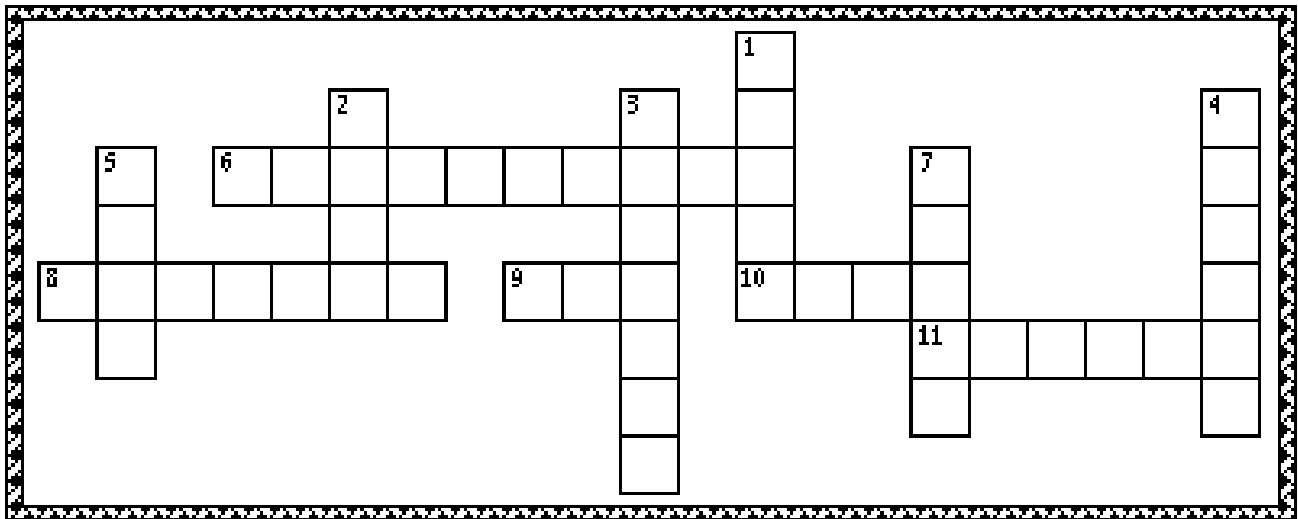

- 6 ACROSS "Then the kingdom of heaven shall be likened to ten virgins who took their lamps and went out to meet the ____." **MATTHEW 25:1**
- 2 DOWN "Now five of them were _____, and five were foolish." **MATTHEW 25:2**
- 3 DOWN "Those who were _____ took their lamps and took no oil with them..." **MATTHEW 25:3**
- 9 ACROSS "...but the wise took _____ in their vessels with their lamps." **MATTHEW 25:4**
- 8 ACROSS "But while the bridegroom was _____, they all slumbered and slept." **MATT.HEW 25:5**
- 11 ACROSS "And at midnight a cry was heard, 'Behold, the bridegroom is _____; go out to meet him!' "**MATTHEW 25:6**
- 1 DOWN "...the foolish said to the wise, 'Give us some of your oil, for our _____ are going out.' "**MATTHEW 25:8**
- 4 DOWN "But the wise answered, saying, 'No, lest there should not be _____ for us and you...' "**MATTHEW 25:9**
- 10 ACROSS "...the bridegroom came, those who were ready went in with him to the wedding; and the door was _____." **MATTHEW 25:10**
- 5 DOWN "Afterward, the other virgins came also, saying, 'Lord, Lord, _____ to us!' But he answered and said , 'Assuredly, I say to you, I do not know you.' "**MATTHEW 25:11-12**
- 7 DOWN "_____ therefore, for you know neither the day nor the hour in which the Son of Man is coming." **MATTHEW 25:13**

Bible Story 229

THE LAST SUPPER

LUKE 22:7-20



"Jesus presents the new covenant to His disciples at the last supper."
Luke 22:7 – 20

229. THE LAST SUPPER

(LUKE 22:7-20)

MEMORY VERSE:

"Then He said to them, 'With fervent desire I have desired to eat this Passover with you before I suffer; for I say to you, I will no longer eat of it until it is fulfilled in the kingdom of God.' " LUKE 22:15-16

CIRCLE THE CORRECT WORDS:

1. "And He sent Peter and John saying, 'Go and prepare the (**BREAKFAST, PASSOVER**) for us, that we may eat.' " LUKE 22:8
2. "And He said to them, 'Behold, when you have entered the city, a man will meet you carrying a (**PITCHER, GLASS**) of water; follow him into the house which he enters." LUKE 22:10

TRUE OR FALSE:

3. "Then you shall say to the master of the house, 'The Teacher says to you, "Where is the guest room in which I may eat the Passover with My disciples?" ' " LUKE 22:11
TRUE OR FALSE

CIRCLE THE CORRECT WORDS:

4. "Then he will show you a large, furnished upper (**ROOM, ROOF**); there make ready." LUKE 22:12
5. "And when the hour had come, He sat down, and the twelve (**SCRIBES, APOSTLES**) with Him." LUKE 22:14

TRUE OR FALSE:

6. "He took the cup and gave thanks, and said, 'Take this and divide it among yourselves.' " LUKE 22:17
TRUE OR FALSE
7. "And He took bread, gave thanks and broke it, and gave it to them, saying, 'This is my body which is given for you; do this in remembrance of Me.' " LUKE 22:19
TRUE OR FALSE
8. "Likewise He took the cup after supper, saying, 'This cup is the new covenant in My blood, which is shed for you.' " LUKE 22:20
TRUE OR FALSE

229. THE LAST SUPPER

(LUKE 22:7-20)

E T V H B F Y Q M L D B Y B C
H J L Y Y J Q U I S C E J U I
E H I I D U Q S O R V W P W I
I B S O G S I H T S O G T C D
S C J F T B M B B B S F H P Z
J G D I N N Y B K B K Z E R P
F H E G C K A M E Y O U N F Z
P G H Q B B H N Y Z L A D M V
K Q S B E D F N E F D N Y E U
A P B F B R O V T V B L O O D
R C J B Y C O S E W O S I T D
W P H J B Z I F Z B B C B L W
K E L K H C I H W Y A H L M E
H Q N V Z R H L Q L B U O E E
I B Q O U D H B V N R S U Z B

FIND THE WORDS OF THIS SCRIPTURE IN THE PUZZLE ABOVE

"This cup is the new covenant in My blood, which is shed for you."

LUKE 22:20



229. THE LAST SUPPER

(LUKE 22:7-20)

MEMORY VERSE:

"Then He said to them, 'With fervent desire I have desired to eat this Passover with you before I suffer; for I say to you, I will no longer eat of it until it is fulfilled in the kingdom of God.' " LUKE 22:15-16

FILL IN THE BLANKS:

1. "And He sent Peter and John saying, 'Go and prepare the _____ for us, that we may eat.' " LUKE 22:8
2. "And He said to them, 'Behold, when you have entered the city, a man will meet you carrying a _____ of water; follow him into the house which he enters." LUKE 22:10

TRUE OR FALSE:

3. "Then you shall say to the master of the house, 'The Teacher says to you, 'Where is the guest room in which I may eat the Passover with My disciples?' " " LUKE 22:11
TRUE OR FALSE

FILL IN THE BLANKS:

4. "Then he will show you a large, furnished _____; there make ready." LUKE 22:12
5. "And when the hour had come, He sat down, and the twelve _____ with Him." LUKE 22:14

TRUE OR FALSE:

6. "He took the cup and gave thanks, and said, 'Take this and divide it among yourselves.' " LUKE 22:17
TRUE OR FALSE
7. "And He took bread, gave thanks and broke it, and gave it to them, saying, 'This is my body which is given for you; do this in remembrance of Me.' " LUKE 22:19
TRUE OR FALSE

FILL IN THE BLANKS:

8. "Likewise He took the cup after supper, saying, 'This cup is the _____ in My blood, which is shed for you.' " LUKE 22:20

229. THE LAST SUPPER

(LUKE 22:7-20)

S U D D J T J M L D U U S O K P B C Y S Y T A V U D B I S V
 Q K V C H P Y S S K B L Z J W E S E B Z B L V B O I H L O S
 A N V B G S G O N B R Y R S W I M B C R F N T W B O Q N K D
 N R L O B J H A P S J L O Z B P H Z M L P J P M T B A D S R
 W F C P A V S L M H Z H J N L L V B B B N O G V L E E G J F
 V J L O B D E K N P F B L W R E Y E A C I I F Z R O D W F N
 V L V R H T Q N S P J K L I Q P B Q K R D M K Q F N B Z R V
 W F N J P T M M I R F E A O B B L A I S I B K B F R I M C V
 K Z M Y T Q B G H B E K C V R S M L L K L Z O U Z L Y F O B
 U V D Y Q F B G T N O B G N H N E B O G G D C W R B Z A R W
 O O J M B N C T Q G R D E M A U J F Z W R C T D F I S K L J
 B B C G O F B E Q B I V H G N R L H I T A A N Y M D F Z S B
 O C M B N T B L H L I O G D N W B V J D F B B N C V A E P E
 Q D Y U B H Y S V G Y F N O V S D M Z C W F B B R Z K A E D
 J Q S O B D U V Z L S B N T G C Z E E V V L Q P I R Q H F C
 V L O V B T W P U N Y I W C R T P L T M B I D H P K S V Z V
 O O J V I N D Z D B D Q B B B P D C T S E H Y Q Z E W L L H
 I J I R F Y O S F Z Y R W V Z M E O I B Q R C O V G Y V V H
 Z W M F A B K M H S B K B N L S B J J B J V Z Z Q I U R O A
 E Z O W W P J B G V O D V V B D L I I Y B M Y F Q V F E L H
 B N Y P B B Q A U M J F B M I Q I T J U O Y S L U M I R Z B
 S Z D W B U B B Q O C H H U V H A B B F A E V Q S V E T J E
 W C V V Y M Z I J N V L C O V E I I B D S Y B P D O O Q P U
 Q U U G H L E Y V G G D R B T N R U R Q B Y T S E V Z S E D
 O Z B J C N P T Q I W I O M L P O K B N W S G B B O E W N J
 R H S T I Z Q F D C H P F G C T N B Q N D Q H U B F R S R T
 G Z S F H H L Z D N H M O Q M L T T B F I B Q D U B I J B Q
 C M O G W R A B D E B W Y O G Z V B H Y A Y Z Z Q J Y R I B
 I U V J K A L C V B B L K T K T B F L I J J T O J Y M Q R U
 G D Z W Y A L S V P B G E H M T K A E V S P W B A T S U B V

FIND THE WORDS FROM THE SCRIPTURE BELOW IN THE PUZZLE ABOVE

"This is My body which is given for you; do this in remembrance of Me."

LUKE 22:19



229. THE LAST SUPPER

(LUKE 22:7-20)

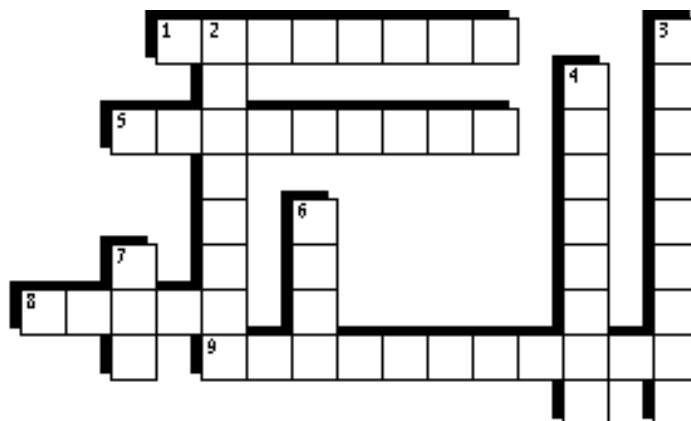

- 2 DOWN "And He sent Peter and John saying, 'Go and prepare the _____ for us, that we may eat.' " **LUKE 22:8**
- 8 ACROSS "And He said to them, 'Behold, when you have entered the city, a man will meet you carrying a pitcher of water; follow him into the _____ which he enters.' " **LUKE 22:10**
- 5 ACROSS "Then you shall say to the master of the house, 'The Teacher says to you, "Where is the guest room in which I may eat the Passover with My _____?" ' " **LUKE 22:11**
- 6 DOWN "Then he will show you a large, furnished upper _____; there make ready." **LUKE 22:12**
- 1 ACROSS "And when the hour had come, He sat down, and the twelve _____ with Him." **LUKE 22:14**
- 3 DOWN "Then He said to them, 'With fervent desire I have desired to eat this Passover with you before I suffer; for I say to you, I will no longer eat of it until it is _____ in the kingdom of God.' " **LUKE 22:15-16**
- 7 DOWN "He took the _____ and gave thanks, and said, 'Take this and divide it among yourselves.' " **LUKE 22:17**
- 9 ACROSS "And He took bread, gave thanks and broke it, and gave it to them, saying, 'This is my body which is given for you; do this in _____ of Me.' " **LUKE 22:19**
- 4 DOWN "Likewise He took the cup after supper, saying, 'This cup is the new _____ in My blood, which is shed for you.' " **LUKE 22:20**

Bible Story 230

**THE MASTER
BECOMES
A SERVANT**

JOHN 13:1-17

230. THE MASTER BECOMES A SERVANT

(JOHN 13:1-17)



"After that he poureth water into a bason, and began to wash the disciples' feet, and to wipe *them* with the towel wherewith he was girded."

JOHN 13:5

230. THE MASTER BECOMES A SERVANT

(JOHN 13:1-17)

MEMORY VERSE:

"He who is greatest among you shall be your servant. And whoever exalts himself will be abased, and he who humbles himself will be exalted." MATTHEW 23:11-12

TRUE OR FALSE:

1. "...Jesus knew that His hour had come that He should depart from this world to the Father..." **JOHN 13:1**

TRUE OR FALSE

CIRCLE THE CORRECT WORD:

2. "Jesus, knowing that the (**FATHER, WORLD**) had given all things into His hands, and that he had come from God and was going to God." **JOHN 13:3**

FILL IN THE BLANK:

3. "...He poured water into a basin and began to wash the disciples' _____." **JOHN 13:5**

TRUE OR FALSE:

4. "Peter said to Him, 'You shall never wash my feet!' Jesus answered him, 'If I do not wash you, you have no part with Me.'" **JOHN 13:8**

TRUE OR FALSE

CIRCLE THE CORRECT WORD:

5. "Jesus said to him, 'He who is bathed needs only to wash his feet, but is (**PARTIALLY, COMPLETELY**) clean.'" **JOHN 13:10**

TRUE OR FALSE:

6. "So when He had washed their feet, taken His garments, and sat down again, He said to them, 'Do you know what I have done? You call Me Teacher and Lord, and you say well, for so I am.'" **JOHN 13:12-13**

TRUE OR FALSE

7. "Most assuredly, I say to you, a servant is not greater than his master; nor is he who is sent greater than he who sent him." **JOHN 13:16**

TRUE OR FALSE

8. "If you know these things, happy are you if you do them." **JOHN 13:17**

TRUE OR FALSE

230. THE MASTER BECOMES A SERVANT (JOHN 13:1-17)

T R E T A E R G Q V O P W B G
 B L G P C J T O R B J J D G Z
 I I F E Q B E T I S J H W Y J
 A L O R D B J A E V E G Y P P
 M O R E H C A E T L J E S U S
 B V H S I R Z N L M P E P Y N
 S Q A G W B Z R S A E M Z B U
 U Z W D Z K K P T Z T U A D O
 P S E L P I C S I D E T W X B
 P U W E T E E F F S R N B R E
 E A W P R E C I A H A A M C L
 R N A Z R F T Q Y M W V W G L
 P A S S O V E R Y B L R U R M
 T M H C Q J I D O S Z E F G S
 Y R E T S A M J F V B S I N Z

DISCIPLES
 EXAMPLE
 FEET
 GREATER
 JESUS

LORD
 MASTER
 PASSOVER
 PETER

SERVANT
 SUPPER
 TEACHER
 WASH

ENTER HERE

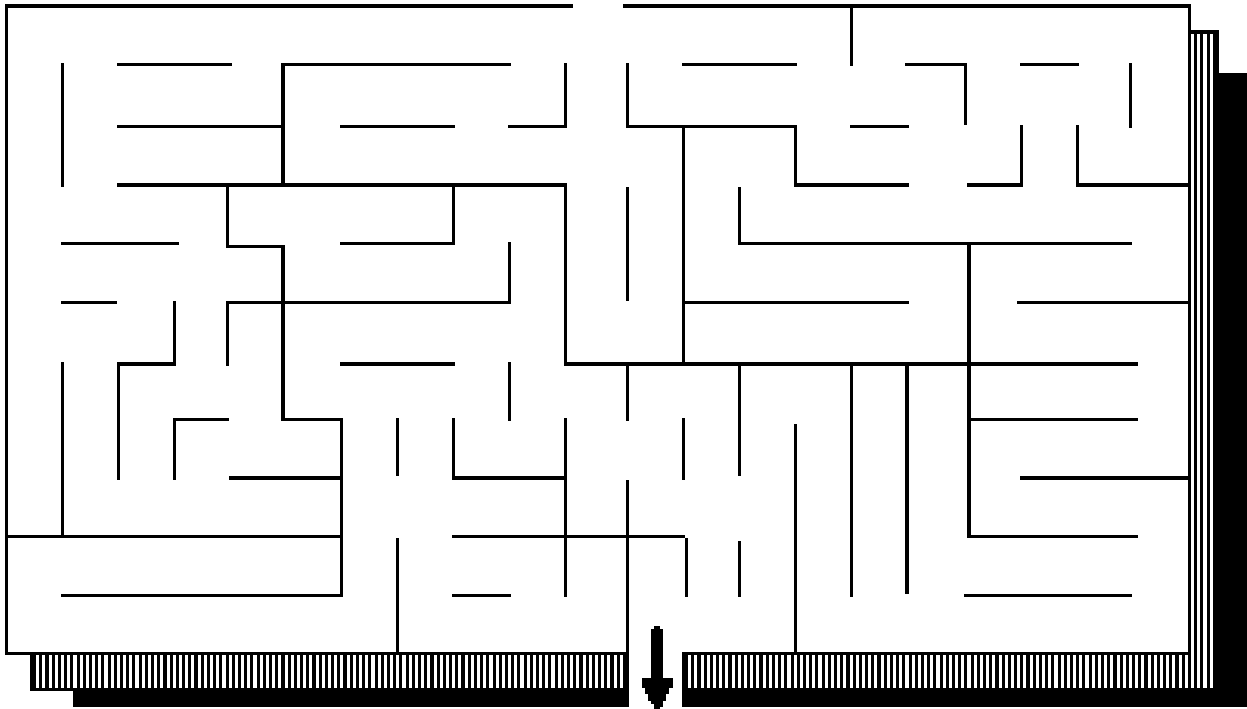

230. THE MASTER BECOMES A SERVANT

(JOHN 13:1-17)

MEMORY VERSE:

"He who is greatest among you shall be your servant. And whoever exalts himself will be abased, and he who humbles himself will be exalted." MATTHEW 23:11-12

TRUE OR FALSE:

1. "...Jesus knew that His hour had come that He should depart from this world to the Father..." **JOHN 13:1**

TRUE OR FALSE

FILL IN THE BLANKS:

2. "Jesus, knowing that the _____ had given all things into His hands, and that he had come from God and was going to God." **JOHN 13:3**
3. "...He poured water into a basin and began to wash the disciples' _____." **JOHN 13:5**

TRUE OR FALSE:

4. "Peter said to Him, 'You shall never wash my feet!' Jesus answered him, 'If I do not wash you, you have no part with Me.'" **JOHN 13:8**

TRUE OR FALSE

FILL IN THE BLANKS:

5. "Jesus said to him, 'He who is bathed needs only to wash his feet, but is _____ clean.'" **JOHN 13:10**
6. "So when He had washed their feet, taken His garments, and sat down again, He said to them, 'Do you know what I have done? You call Me _____ and Lord, and you say well, for so I am.'" **JOHN 13:12-13**
7. "Most assuredly, I say to you, a servant _____ greater than his master; nor is he who is sent greater than he who sent him." **JOHN 13:16**

TRUE OR FALSE:

8. "If you know these things, happy are you if you do them." **JOHN 13:17**

TRUE OR FALSE

230. THE MASTER BECOMES A SERVANT (JOHN 13:1-17)

M J L Y D D H V G I Z G J U B Y M A T W D N S G B O N K C O
 C V G Q H R E H C A E T O H E F K E Q T Y R F B T T H S E O
 T I B P I H O S G N Y V B Y A B N L T U E Y B W F S I M B Y
 Q E Y V I M F H V T R E F J Q O B B I T U T C N U E B M Q D
 F A V M A Y B D B T B A O A T W H D E R O I L S Z R P G G U
 D A Z V L U X L N S I B B L S B A P B K B T E E F E F H T Q
 N Q Y O N K Z A I Y D Y V C C C G M A I Z J J S H O T A H K
 G Z U T F S V H F T A Z E Q T W K M C Z S A Y U Z D N I S N
 V P V J R R G Z B G M R H Y B A S M D U E A C B P E A O Y J
 G F M Z E E F E L R D J U D A S S B N W J F L M R A F Y Z R
 K M Y S D P B S Y R I Q C V H V U E V M A S T E R F W A U B
 Z G A O K P C Q E K R V P F G W L O L A M K S I U V B E B W
 D E J V S U B U Q U G E A D A B M R B P B B S D K A V H T K
 I W R L F S Z Z T P K Y S Q K P O H C T I W C L B S N Q O F
 Y K O C B S A F F S F B S D E F T P V C T C A A A V F O U N
 N R M E Y V K E B Q Q P O I N A J N C O B J S S H B B V H R
 A G Q G D Y E N B V N B V D C B B T A B K Y N I H Z B C E N
 P B D V C T I M K Y I N E B B E H Y W U Q Z B W D P S C D B
 N J T T P Z L F S E G Y R V C G Z L Z M A I R T A N F C C I
 A A O Y L N U I I Z J Q K W C G J C Z P Q V E H N S H Z P D
 W H U E E O H E S P L Q Z Z T H L O E A T I V F G Z E J W M
 Q P C R X W B V B A D B M F B B L Y T J V J M I R I Y S B L
 L R H B A K P M W U E F J O W Y B Y Q Y I S T T E T E Z Z D
 Q M E W M I P N J T K E A J R B Y C H K J V Q D A J D D K H
 K A Q I P Z Y I R Y G Z P L S A C Y D Q I Q S R T B J U I Q
 E U J B L A J A F E C H N N Q P Z D D K Z O U O E I B M I C
 K L B U E A Y M K D B F E A U E A W S Y V D G L R Y B J U M
 H M B W R W V J G K B M P Y R U J S F O L B G K I B R Y V J
 Y I H N Z C T C A J V C B O G R L A N O G S B C K Q D U N W
 B F Z Y P H C W Z Y K G U P L B T B V Y N Q H V R S R R A

BETRAY
DISCIPLES
EXAMPLE
FEET
GREATER

JESUS
JUDAS
LORD
MASTER
PASSOVER

PETER
SERVANT
SUPPER
TEACHER
WASH

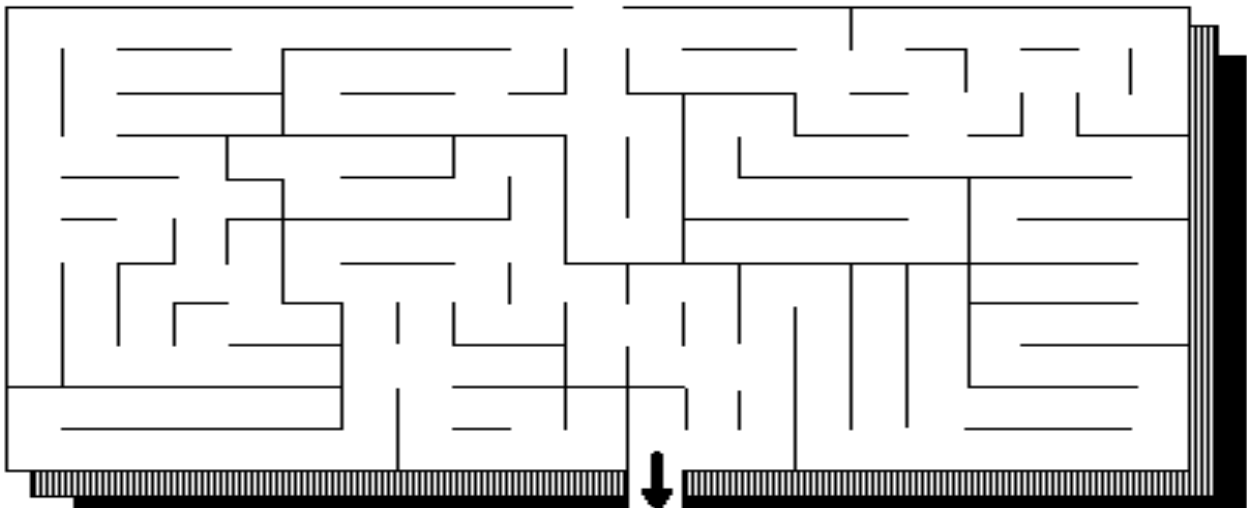

230. THE MASTER BECOMES A SERVANT

(JOHN 13:1-17)

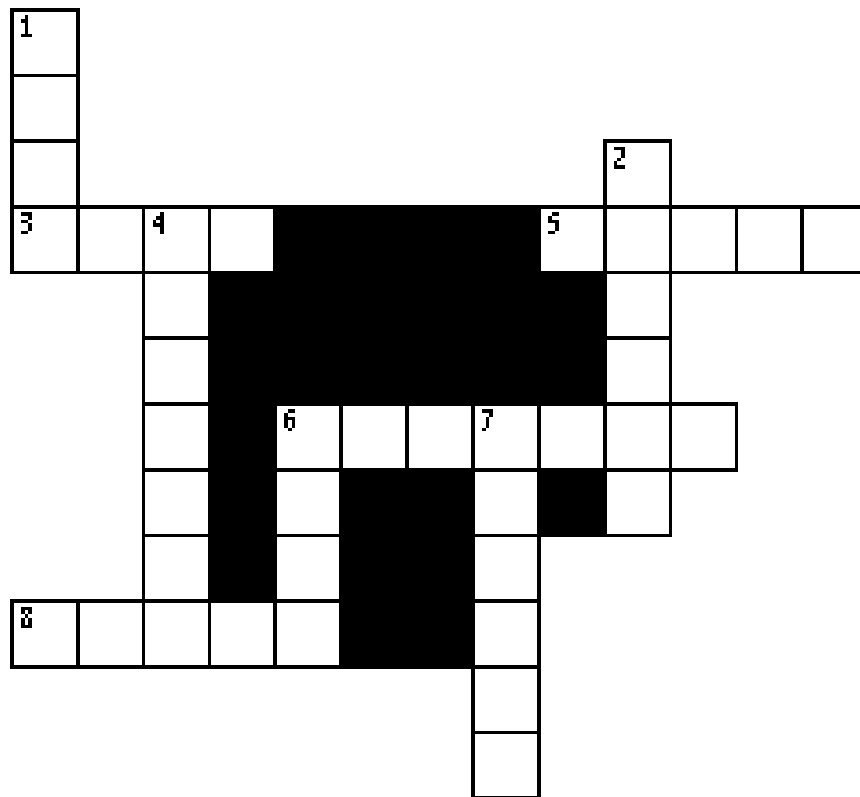

- 6 ACROSS "He who is greatest among you shall be your servant. And whoever exalts himself will be abased, and he who _____ himself will be exalted." **MATTHEW 23:11-12**
- 6 DOWN "...Jesus knew that His _____ had come that He should depart from this world to the Father..." **JOHN 13:1**
- 2 DOWN "Jesus, knowing that the _____ had given all things into His hands, and that he had come from God and was going to God." **JOHN 13:3**
- 3 ACROSS "...He poured water into a basin and began to _____ the disciples' feet." **JOHN 13:5**
- 8 ACROSS "_____ said to Him, 'You shall never wash my feet!' Jesus answered him, 'If I do not wash you, you have no part with Me.'" **JOHN 13:8**
- 7 DOWN "Jesus said to him, 'He who is _____ needs only to wash his feet, but is completely clean.'" **JOHN 13:10**
- 1 DOWN "So when He had washed their feet, taken His garments, and sat down again, He said to them, 'Do you _____ what I have done? You call Me Teacher and Lord, and you say well, for so I am.'" **JOHN 13:12-13**
- 4 DOWN "Most assuredly, I say to you, a _____ is not greater than his master; nor is he who is sent greater than he who sent him." **JOHN 13:16**
- 5 ACROSS "If you know these things, _____ are you if you do them." **JOHN 13:17**

Bible Story 231

**THE WAY,
THE TRUTH,
& THE LIFE**

JOHN 14:1-6

CHRISTUS

Life

Truth

John

14:1-6

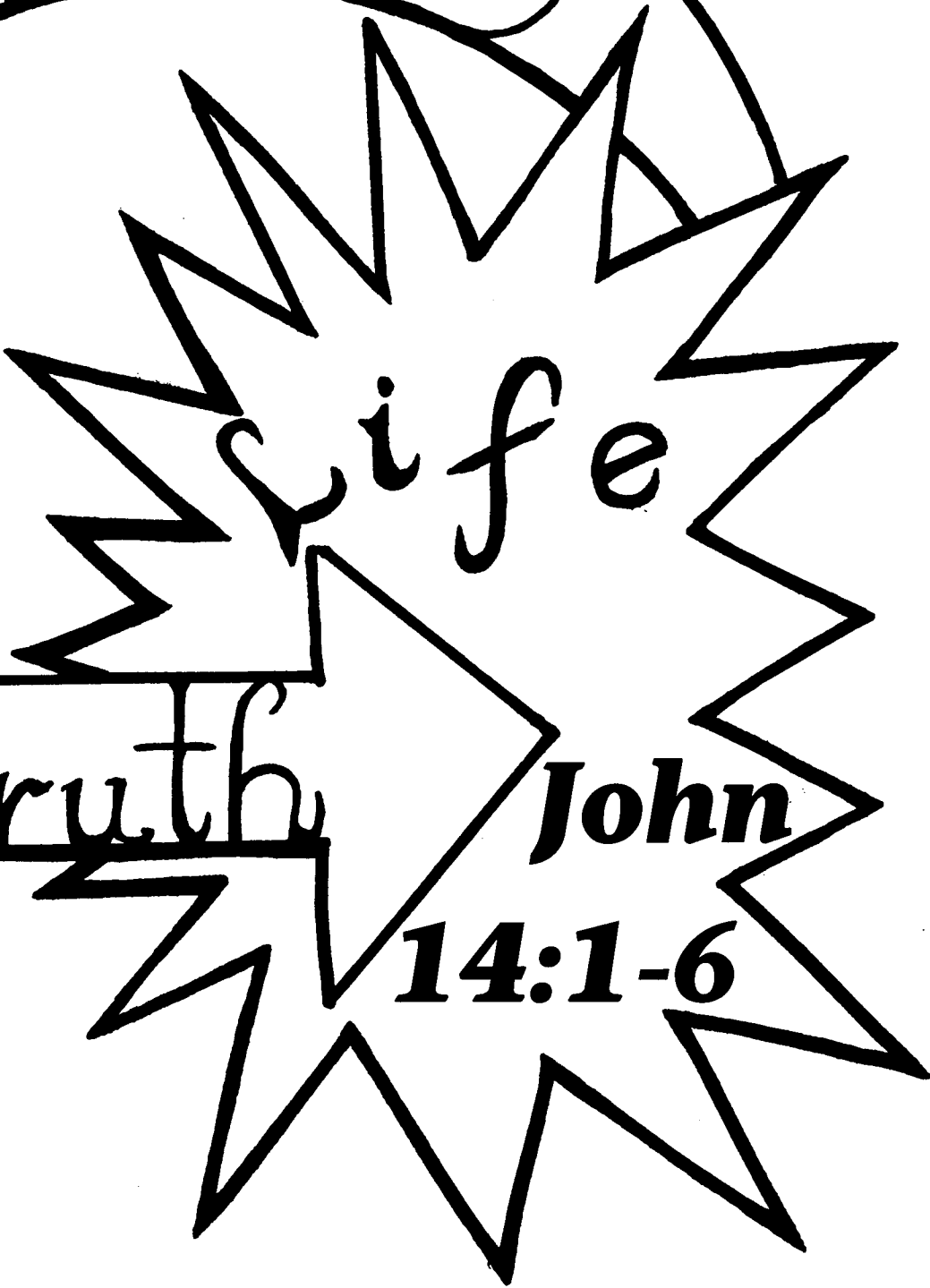
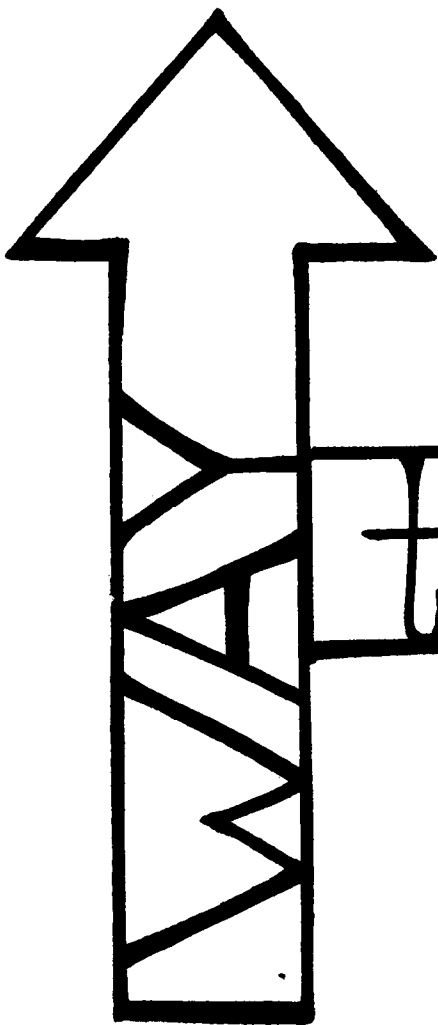

231. THE WAY, THE TRUTH, AND THE LIFE

(JOHN 14:1-6)

MEMORY VERSE:

"Let not your heart be troubled; you believe in God, believe also in Me." JOHN 14:1

CIRCLE THE CORRECT WORDS:

1. "Let not your (**HEART, HEAD**) be troubled; you believe in God, believe also in Me." JOHN 14:1
2. "In My Father's house are many (**MOUNTAINS, MANSIONS**); if it were not so, I would have told you..." JOHN 14:2

TRUE OR FALSE:

3. "...I go to prepare a place for you." JOHN 14:2
TRUE OR FALSE
4. "And if I go and prepare a place for you, I will come again and receive you to Myself; that where I am, there you may be also." JOHN 14:3
TRUE OR FALSE
5. And where I go you don't know, and the way you don't know. JOHN 14:4
TRUE OR FALSE

CIRCLE THE CORRECT ANSWER:

6. "Thomas said to Him, 'Lord, we (**DO, DO NOT**) know where You are going, and how can we know the way?' " JOHN 14:5

FILL IN THE BLANKS:

7. "Jesus said to him, 'I am the _____, the _____, and the _____. No one comes to the Father except through Me.' " JOHN 14:6

231. THE WAY, THE TRUTH AND THE LIFE

(JOHN 14:1-6)

T V A C B Z N R O H J U B R Z
H Q W C R Z R I F M E W M C J
R Z B Q B B P L V Z A D W R P
O U P I B C E S U O H H U E N
U A E V E I L E B S W E F H U
G Y E W E T I S B V L A I T O
H A S Z F I Q T S O Z R B A F
M W G K J O D T R J B T G F L
B S N O I S N A M O P W Y G L
T N D K T E C A L P U Y P R M
Y M H T U R T F V J J B Y G S
L G E Q E T J A M E E P L N Z
P R E P A R E Y A F H S B E F
I F P J J A Q Y Z I G Z U G D
O H Z B W O N K S L E W D S P

BELIEVE
FATHER
HEART
HOUSE
JESUS

KNOW
LIFE
MANSIONS
PLACE
PREPARE

THROUGH
TROUBLED
TRUTH
WAY

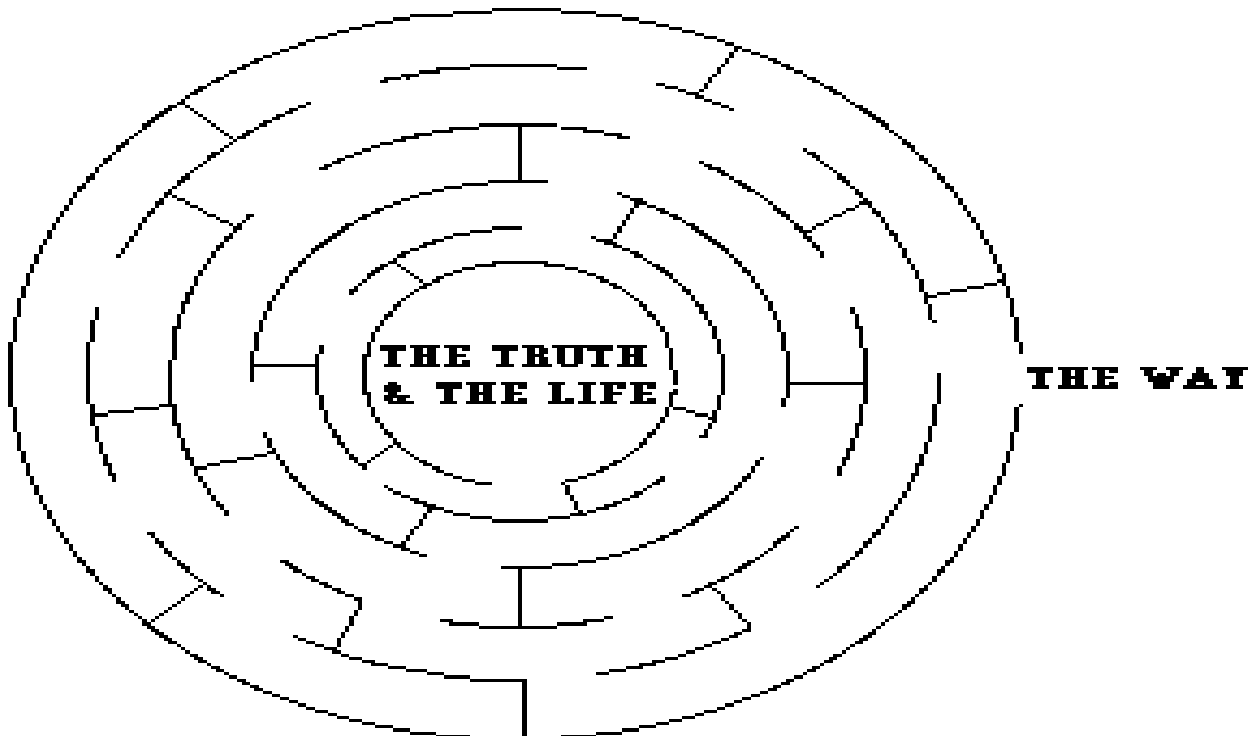

231. THE WAY, THE TRUTH, AND THE LIFE

(JOHN 14:1-6)

MEMORY VERSE:

"Let not your heart be troubled; you believe in God, believe also in Me." JOHN 14:1

FILL IN THE BLANKS:

1. "Let not your _____ be troubled; you believe in God, believe also in Me." **JOHN 14:1**
2. "In My Father's house are many _____; if it were not so, I would have told you..."
JOHN 14:2

TRUE OR FALSE:

3. "...I go to prepare a place for you." **JOHN 14:2**
TRUE OR FALSE
4. "And if I go and prepare a place for you, I will come again and receive you to Myself; that where I am, there you may be also." **JOHN 14:3**
TRUE OR FALSE
5. And where I go you don't know, and the way you don't know. **JOHN 14:4**
TRUE OR FALSE

FILL IN THE BLANKS:

6. " _____ said to Him, 'Lord, we do not know where You are going, and how can we know the way?' " **JOHN 14:5**
7. "Jesus said to him, 'I am the _____, the _____, and the _____. No one comes to the Father except through Me.'" **JOHN 14:6**

231. THE WAY, THE TRUTH AND THE LIFE (JOHN 14:1-6)

V D I I C F Q I C B Y P G Z J J W R D R D Z F B A
 B T W B F H T O C C O J Y F U T U L D Y T R U T H
 M A P T B N R V Q T F H P P B F D W O Y B L B P U
 C S P D B G A Q I I V G Y G O E A J K D B U S P E
 B T W Y Y B E Z W O B E B B I P V T Q J B T M U F
 H O Q H N G H U Z T S U D B T L S E H J E S U S P
 P K T U M R T A K A V W R U E J J U I E A M O Z T
 D T N H G U O R H T M D C B J C H O B L R O A V O
 E W A O H Q A N K N A W G C B V Q E L Y E E T F N
 B F B Q W I Q M Q R Z Y R U B T O P W I A B M R I
 C A U S L P F G J P S P G M P W E F I L T W Z B J
 P M H S D H H F B I H Z M D Z H E T B P W M J B J
 O F E I R Z P H B Q M W N A Y P W C I T L B S Y Y
 G H R L E I J A R D B B G L N J E S J V A N M R T
 U K D E L B U O R T S M Z S Y S B C S R P O B G H
 P N J S U V T W B J V W J V O H I H U F P B P I G
 M C S J W V B B K Q O U P R J Q B O E E A B C B F
 N U T F J B I P E R J F N B F O S U N J B L D U Y
 R Q A F N Q A E F I J I U M A A U E A S V P T A Q
 B D Z O S Y M S J L E B O L H E S U O H Q M B V D
 P R E P A R E G T S A P F B A W H C V O D C B B C
 D C S P Z E B D E T W L L B H V P N D U V C G O M
 C N D E K L T E J F L A L A Z M E Q Q G S V E U P
 U W J O B N Y P Z A Z C M C Y F V L E F M Z I V O
 G T Q O Z V L Z Z Y B E S W N S A K N B C B B Z E

BELIEVE
 FATHER
 HEART
 HOUSE
 JESUS

KNOW
 LIFE
 MANSIONS
 PLACE
 PREPARE

THROUGH
 TROUBLED
 TRUTH
 WAY

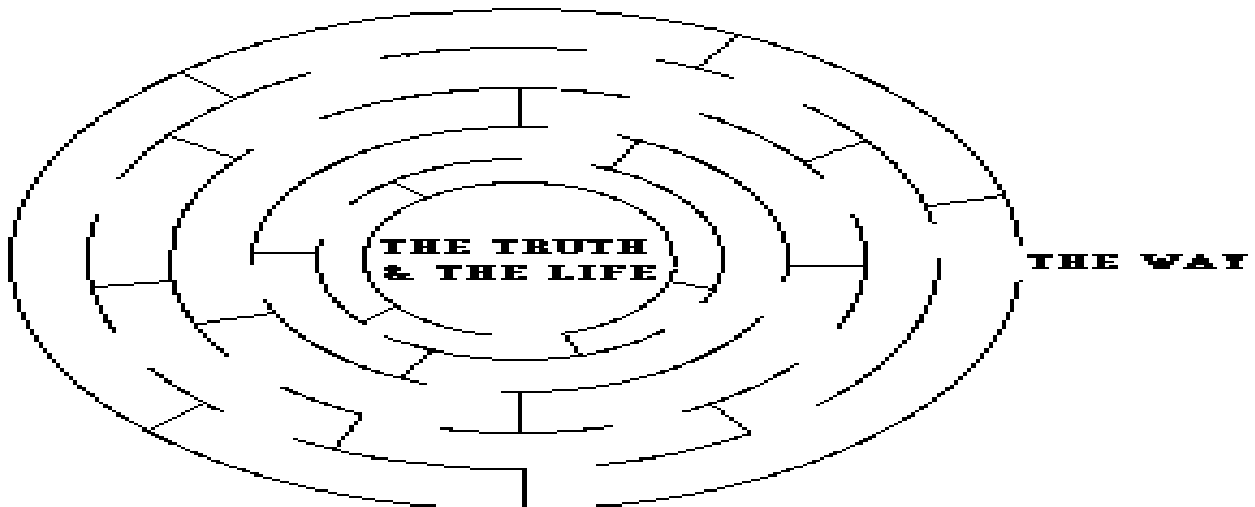

231. THE WAY, THE TRUTH, AND THE LIFE

(JOHN 14:1-6)

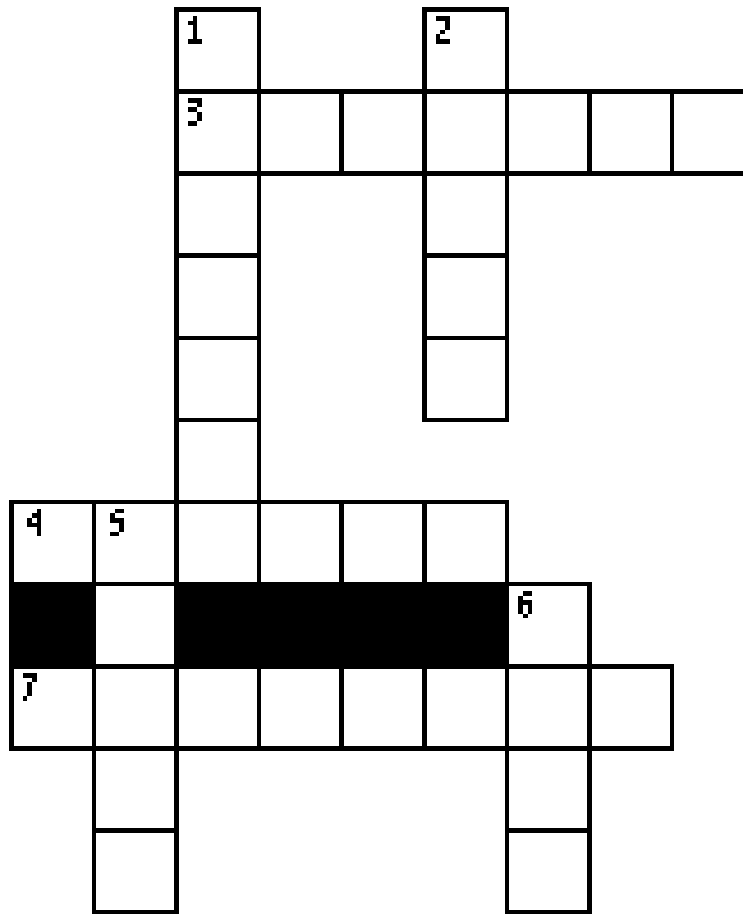

- 5 DOWN "Let not your _____ be troubled; you believe in God, believe also in Me." **JOHN 14:1**
- 7 ACROSS "In My Father's house are many _____; if it were not so, I would have told you..." **JOHN 14:2**
- 1 DOWN "...I go to _____ a place for you." **JOHN 14:2**
- 3 ACROSS "And if I go and prepare a place for you, I will come again and _____ you to Myself; that where I am, there you may be also." **JOHN 14:3**
- 6 DOWN "And where I go you _____, and the way you know." **JOHN 14:4**
- 4 ACROSS "Thomas said to Him, 'Lord, we do not know where You are going, and how can we know _____ _____?'" **JOHN 14:5**
- 2 DOWN "_____ said to him, 'I am the way, the truth, and the life. No one comes to the Father except through Me.'" **JOHN 14:6**

Bible Story 232

THE TRUE VINE

JOHN 15: 1-11

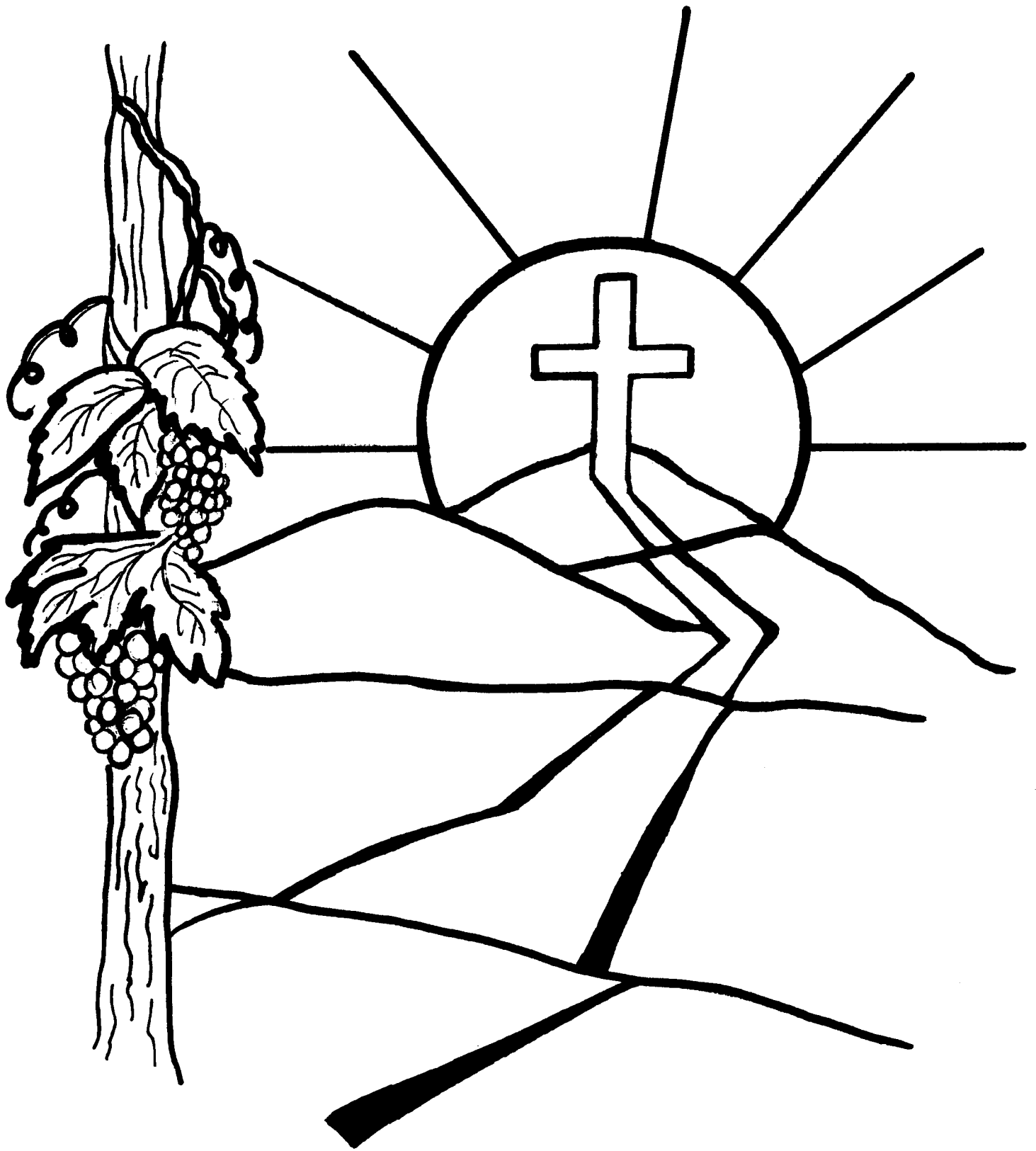

"Jesus said, 'I am the vine, you are the branches. He who abides in Me, and I in him, bears much fruit.'" *John 15:5*

232. THE TRUE VINE (JOHN 15:1-11)

MEMORY VERSE:

"As the Father loved Me, I also have loved you; abide in My love." JOHN 15:9

CIRCLE THE CORRECT WORDS:

1. "I am the (TRUE, GRAPE) vine, and My Father is the vinedresser." JOHN 15:1
2. "Every branch in Me that does not bear (LEAVES, FRUIT) He takes away." JOHN 15:2

Jesus said...

TRUE OR FALSE:

3. "Abide in Me, and I in you..." JOHN 15:4
TRUE OR FALSE

CIRCLE THE CORRECT WORD:

4. "I am the vine, you are the branches. He who abides in Me, and I in him, bears much fruit; for without Me you can do (NOTHING, EVERYTHING)." JOHN 15:5

TRUE OR FALSE:

5. "If anyone does not abide in Me, he is cast out as a branch and is withered..." JOHN 15:6
TRUE OR FALSE
6. "...and they gather them and throw them in the fire, and they are burned." JOHN 15:6
TRUE OR FALSE
7. "By this My Father is glorified, that you bear much fruit." JOHN 15:8
TRUE OR FALSE

FILL IN THE BLANK:

8. "...so you will be My _____." JOHN 15:8

CIRCLE THE CORRECT WORD:

9. "These things I have spoken to you, that My joy may remain in you, and that your joy may be (FULL, GONE)." JOHN 15:11

232. THE TRUE VINE

(JOHN 15:1-11)

A	N	I	A	M	E	R	O	B	P	Y	I	D	G	L
W	E	B	B	Z	A	J	F	S	B	P	E	N	I	V
B	P	B	Y	O	J	Q	V	V	H	U	B	R	Z	L
P	F	R	U	I	T	R	B	O	J	C	R	C	J	M
F	Z	D	E	R	E	H	T	I	W	Z	N	N	P	S
E	A	Q	E	Z	J	E	S	U	S	W	G	A	E	Z
A	C	T	F	B	R	L	V	J	G	B	Y	G	R	D
B	C	J	H	C	P	S	M	E	E	M	P	R	N	B
I	S	T	N	E	M	D	N	A	M	M	O	C	U	B
D	Q	B	J	T	R	T	A	A	U	E	U	R	T	P
E	I	B	T	I	I	F	Z	W	W	W	Y	G	O	G
S	W	R	E	O	Q	A	S	L	S	E	N	U	R	P
V	I	N	E	D	R	E	S	S	E	R	E	R	I	F
G	Z	B	J	T	D	Y	H	Z	D	U	B	N	F	B
D	N	A	E	L	C	Y	M	B	W	F	W	O	R	D

ABIDE
BRANCH
BURNED
CLEAN
COMMANDMENTS
FATHER

FIRE
FRUIT
JOY
PRUNES
REMAIN
JESUS

TRUE
VINEDRESSER
VINE
WITHERED
WORD

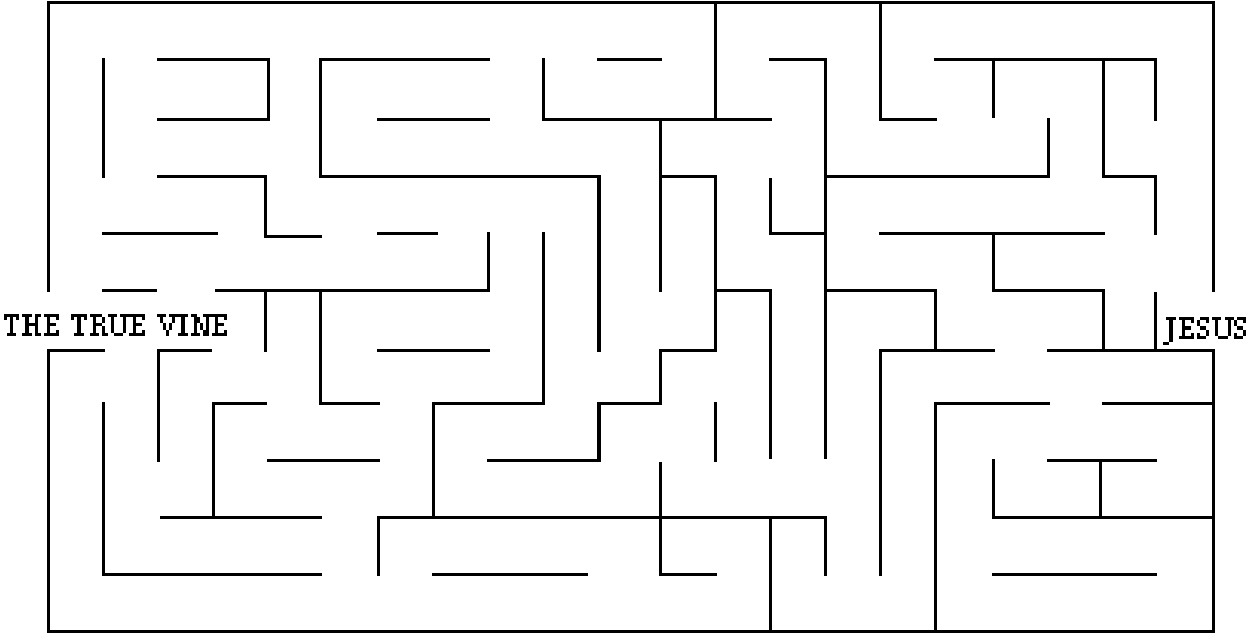

232. THE TRUE VINE

(JOHN 15:1-11)

MEMORY VERSE:

"As the Father loved Me, I also have loved you; abide in My love." JOHN 15:9

FILL IN THE BLANKS:

1. "I am the _____ vine, and My Father is the vinedresser." JOHN 15:1
2. "Every branch in Me that does not bear _____ He takes away." JOHN 15:2

Jesus said...

TRUE OR FALSE:

3. "Abide in Me, and I in you..." JOHN 15:4
TRUE OR FALSE

FILL IN THE BLANK:

4. "I am the vine, you are the branches. He who abides in Me, and I in him, bears much fruit; for without Me you can do _____." JOHN 15:5

TRUE OR FALSE:

5. "If anyone does not abide in Me, he is cast out as a branch and is withered..." JOHN 15:6
TRUE OR FALSE
6. "...and they gather them and throw them in the fire, and they are burned." JOHN 15:6
TRUE OR FALSE
7. "By this My Father is glorified, that you bear much fruit." JOHN 15:8
TRUE OR FALSE

FILL IN THE BLANKS:

8. "...so you will be My _____." JOHN 15:8
9. "These things I have spoken to you, that My joy may remain in you, and that _____." JOHN 15:11

232. THE TRUE VINE

(JOHN 15:1-11)

S H Q W U C T P M H Y Z A H F P Q Q K Z B B G I E
 I S U S E J N I A G B F C Z S E L E D L F R U I T
 L L I E A C I Q Z E D P W Y W P K N B U F B I J C
 S D N H N Q A D S B R G J N A D R R K T B G B J N
 J I P P M I M J H W C B B J B V E U K M S E U Y A
 V R H J G W E Q M D G B B T I A D R N B R A N C H
 F B Z T F Z R R B W R U O P D R D Y E E M I A T I
 F E U D E I F I R O L G I L E L O Y A H S K V H Z
 O U I R H K E I S Y G B T J U W K D T O T B B G S
 P W V B N K J T V P N C E C D J Q J W E O I O F N
 E J V I A E S L W Z G B J V S U R E H T A F W Y C
 T N B A W A D S O O Z M C T J O K I L M A P B Q Z
 R S Q M C Q Z T J W R D K O H E L P A B T P V D B
 U Z Y B B J Z F J B J D K W M P W T P N M U Z C R
 E K R E S S E R D E N I V H Q M K V P O Z Z A M P
 O B E T P B K A E M P L P P O T A R A B J F U P J
 O Z L Y E B C Y A W N S Z J E C I N B U J V I O P
 C F N L S R T Y E U U V Y H W S J F D L S O E R Q
 F H V I G B I O W V O R Y Q E C S N V M M F Y E E
 K N Q O D K O F L F O C O O B H A E Q P E R F A B
 D I S C I P L E S I F L J A K E U J D M B N P Y Q
 B G T V E E T V Z B L M F W L U E O V B P B T U W
 Y B A Q P F A B B G L L A C S E A U S B B B T S G
 N G L L B F N S P Y M B H V B C V G M V D Y O H A
 M R Q Z Z J R V J P S B A M H N D F C Z T R N A M

ABIDE
BRANCH
BURNED
CAST
CLEAN
COMMANDMENTS

DISCIPLES
FATHER
FIRE
FRUIT
FULL
GLORIFIED

JESUS
JOY
LOVE
PRUNES
REMAIN

TRUE
VINEDRESSER
VINE
WITHERED
WORD

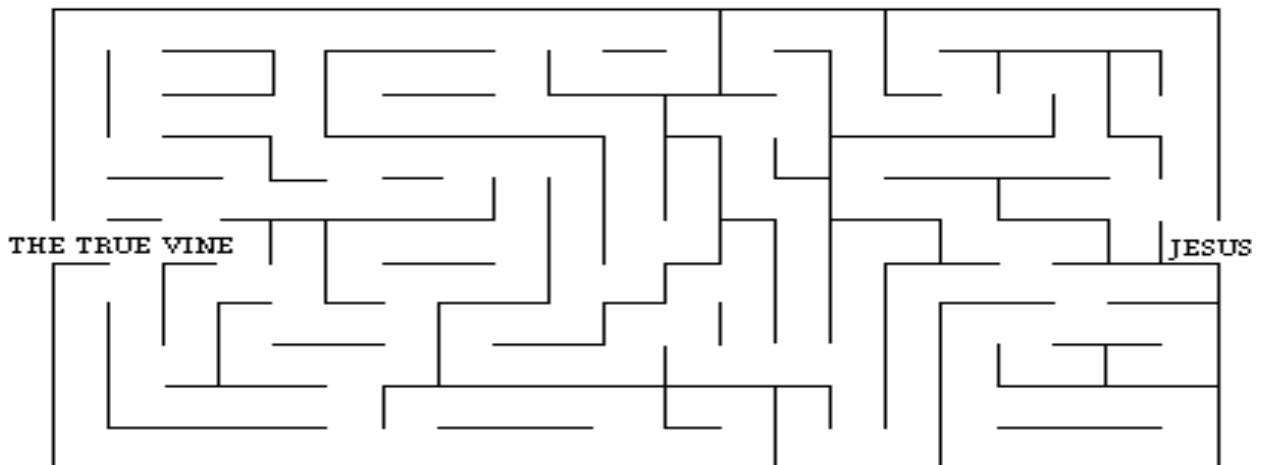

232. THE TRUE VINE

(JOHN 15:1-11)

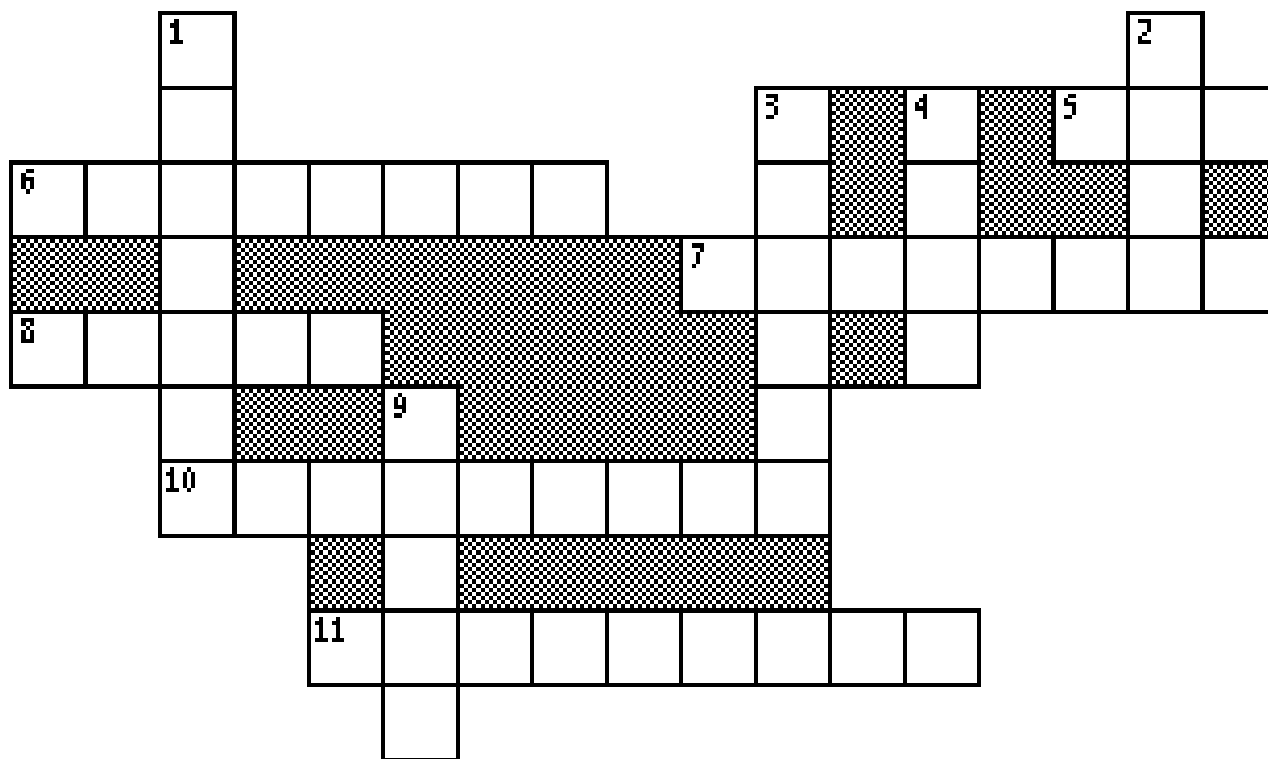

- 4 DOWN "I am the true _____, and My Father is the vinedresser." **JOHN 15:1**
- 9 DOWN "Every branch in Me that does not bear _____ He takes away." **JOHN 15:2**
- 8 ACROSS "_____ in Me, and I in you..." **JOHN 15:4**
- 7 ACROSS "I am the vine, you are the _____..." **JOHN 15:5**
- 1 DOWN "...He who abides in Me, and I in him, bears much fruit; for without Me you can do _____."
JOHN 15:5
- 6 ACROSS "If anyone does not abide in Me, he is cast out as a branch and is _____..." **JOHN 15:6**
- 3 DOWN "...and they gather them and throw them in the fire, and they are _____." **JOHN 15:6**
- 10 ACROSS "By this My Father is _____, that you bear much fruit." **JOHN 15:8**
- 11 ACROSS "...so you will be My _____." **JOHN 15:8**
- 2 DOWN "As the Father loved Me, I also have loved you; abide in My _____." **JOHN 15:9**
- 5 ACROSS "These things I have spoken to you, that My joy may remain in you, and that your _____
may be full." **JOHN 15:11**

Bible Story 233

**THE
GARDEN OF
GETHSEMANE**

LUKE 22:39-53

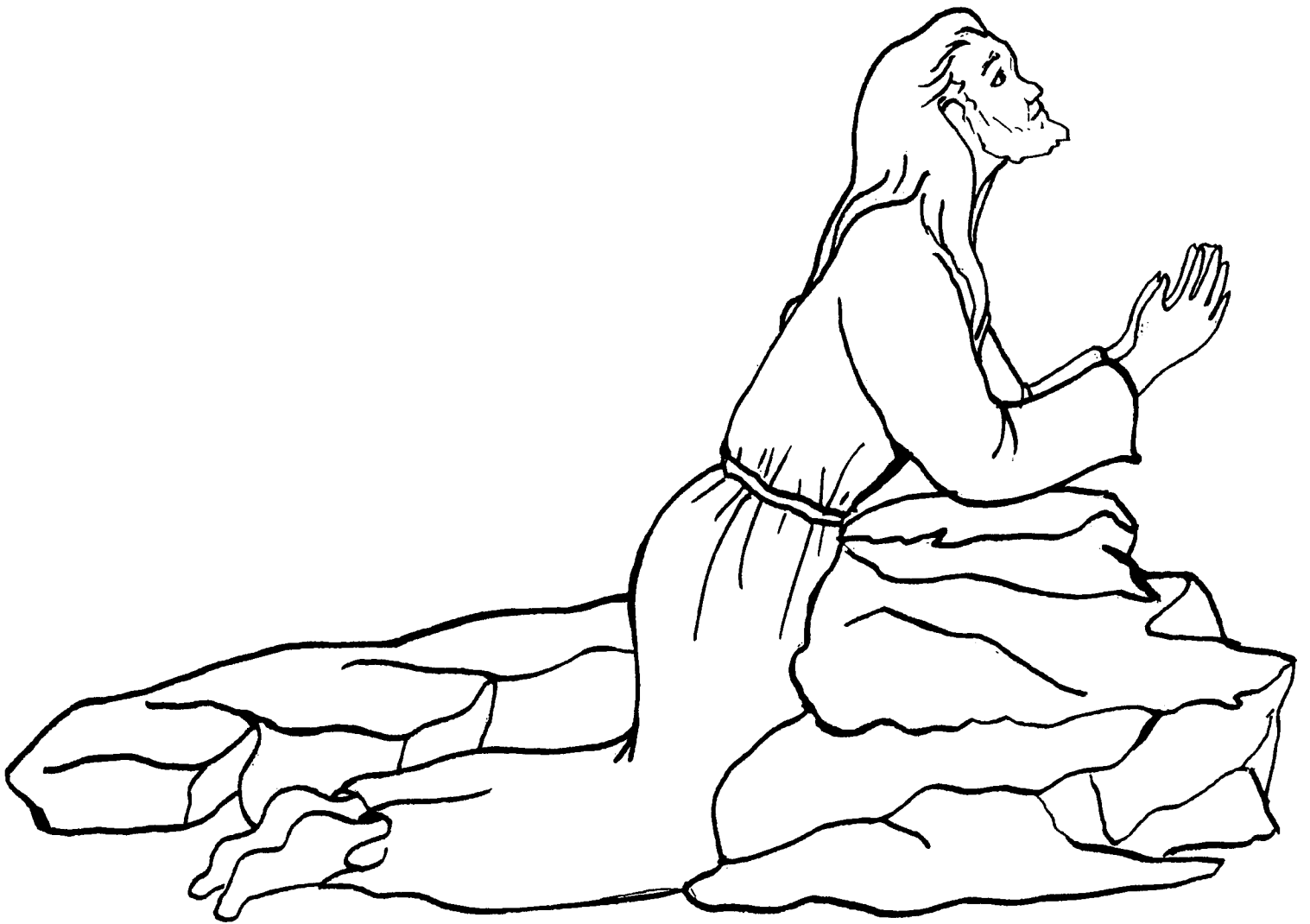

"Jesus prays in the Garden of Gethsemane"
Luke 22:39-53

233. THE GARDEN OF GETHSEMANE

(LUKE 22:39-53)

MEMORY VERSE:

"Pray that you may not enter into temptation." LUKE 22:40

TRUE OR FALSE:

1. "Coming out, He went to the Mount of Olives, as He was accustomed, and His disciples also followed Him." LUKE 22:39

TRUE OR FALSE

2. "When He came to the place, He said to them, 'Pray that you may not enter into temptation.'" LUKE 22:40

TRUE OR FALSE

CIRCLE THE CORRECT WORD:

3. "And He was withdrawn from them about a stone's throw, and He knelt down and (SLEPT, PRAYED)..." LUKE 22:41

TRUE OR FALSE:

4. "...Father, if it is Your will, take this cup away from Me. Nevertheless not My will, but Yours, be done.'" LUKE 22:42

TRUE OR FALSE

CIRCLE THE CORRECT WORDS:

5. "Then an (ANGEL, CLOUD) appeared to Him from heaven, strengthening Him." LUKE 22:43

6. "...His sweat became like great drops of (WATER, BLOOD) falling to the ground." LUKE 22:44

7. "When He rose up from prayer, and had come to His disciples, He found them (PRAYING, SLEEPING) from sorrow." LUKE 22:45

8. "Then He said to them, 'Why do you sleep? Rise and pray, lest you enter into (SLEEP, TEMPTATION).'" LUKE 22:46

TRUE OR FALSE:

9. "And while He was still speaking, behold, a multitude; and he who was called Judas, one of the twelve, went before them and drew near to Jesus to kiss Him." LUKE 22:47

TRUE OR FALSE

FILL IN THE BLANKS:

10. "...one of them struck the servant of the high priest and cut off his right _____." LUKE 22:50

11. "But Jesus answered and said, 'Permit even this.' And He touched his ear and _____ him." LUKE 22:51

TRUE OR FALSE:

12. "Then Jesus said to the chief priests, captains of the temple, and the elders who had come to Him, 'Have you come out, as against a robber, with swords and clubs? When I was with you daily in the temple, you did not try to seize Me. But this is your hour, and the power of darkness.'" LUKE 22:52-53

TRUE OR FALSE

233. THE GARDEN OF GETHSEMANE

(LUKE 22:39-53)

S K I S S Q J T O D T D N U W
L J E B J U D V U B W V Z L T
E U C Q D E W I L L S L D A
E O N A S N Y A R T E B B E E
P E S E L P I C S I D P T L W
I E Q K U R J R S R U O Y A S
N P A P R A Y F G C A M M E B
G T L R E Y I Y N O G A O H K
E S E V I L O F O T N U O M S
V C K L A T L E N K P R E P M
A S D O O L B E B B P E M M S
R C D W V Y P J B K A H B C W
T E M P T A T I O N B T N C O
L H D K D L E G N A V A O V R
W U O I S U S E J A Q F B Z D

AGONY
ANGEL
BETRAY
BLOOD
CUP
DISCIPLES

EAR
FATHER
HEALED
JESUS
JUDAS

KISS
KNELT
MOUNT OF OLIVES
PRAY
SLEEPING

SWEAT
SWORD
TEMPTATION
WILL
YOURS



233. THE GARDEN OF GETHSEMANE

(LUKE 22:39-53)

MEMORY VERSE:

"Pray that you may not enter into temptation." LUKE 22:40

TRUE OR FALSE:

1. "Coming out, He went to the Mount of Olives, as He was accustomed, and His disciples also followed Him." LUKE 22:39

TRUE OR FALSE

2. "When He came to the place, He said to them, 'Pray that you may not enter into temptation.'" LUKE 22:40

TRUE OR FALSE

FILL IN THE BLANK:

3. "And He was withdrawn from them about a stone's throw, and He knelt down and _____." LUKE 22:41

TRUE OR FALSE:

4. "...Father, if it is Your will, take this cup away from Me. Nevertheless not My will, but Yours, be done.'" LUKE 22:42

TRUE OR FALSE

FILL IN THE BLANKS:

5. "Then an _____ appeared to Him from heaven, strengthening Him." LUKE 22:43

6. "...His sweat became like great drops of _____ falling to the ground." LUKE 22:44

7. "When He rose up from prayer, and had come to His disciples, He found them _____ from sorrow." LUKE 22:45

8. "Then He said to them, 'Why do you sleep? Rise and pray, lest you enter into _____.'" LUKE 22:46

TRUE OR FALSE:

9. "And while He was still speaking, behold, a multitude; and he who was called Judas, one of the twelve, went before them and drew near to Jesus to kiss Him." LUKE 22:47

TRUE OR FALSE

FILL IN THE BLANKS:

10. "...one of them struck the servant of the high priest and cut off his right _____." LUKE 22:50

11. "But Jesus answered and said, 'Permit even this.' And He touched his ear and _____ him." LUKE 22:51

TRUE OR FALSE:

12. "Then Jesus said to the chief priests, captains of the temple, and the elders who had come to Him, 'Have you come out, as against a robber, with swords and clubs? When I was with you daily in the temple, you did not try to seize Me. But this is your hour, and the power of darkness.'" LUKE 22:52-53

TRUE OR FALSE

233. THE GARDEN OF GETHSEMANE

(LUKE 22:39-53)



S K I S S Q J T O D T D N U W
L J E B J U D V U B W V Z L T
E U C Q D E W I L L L S L D A
E O N A S N Y A R T E B B E E
P E S E L P I C S I D P T L W
I E Q K U R J R S R U O Y A S
N P A P R A Y F G C A M M E B
G T L R E Y I Y N O G A O H K
E S E V I L O F O T N U O M S
V C K L A T L E N K P R E P M
A S D O O L B E B B P E M M S
R C D W V Y P J B K A H B C W
T E M P T A T I O N B T N C O
L H D K D L E G N A V A O V R
W U O I S U S E J A Q F B Z D

AGONY
ANGEL
BETRAY
BLOOD
CUP
DISCIPLES

EAR
FATHER
HEALED
JESUS
JUDAS

KISS
KNELT
MOUNT OF OLIVES
PRAY
SLEEPING

SWEAT
SWORD
TEMPTATION
WILL
YOURS

233. THE GARDEN OF GETHSEMANE

(LUKE 22:39-53)

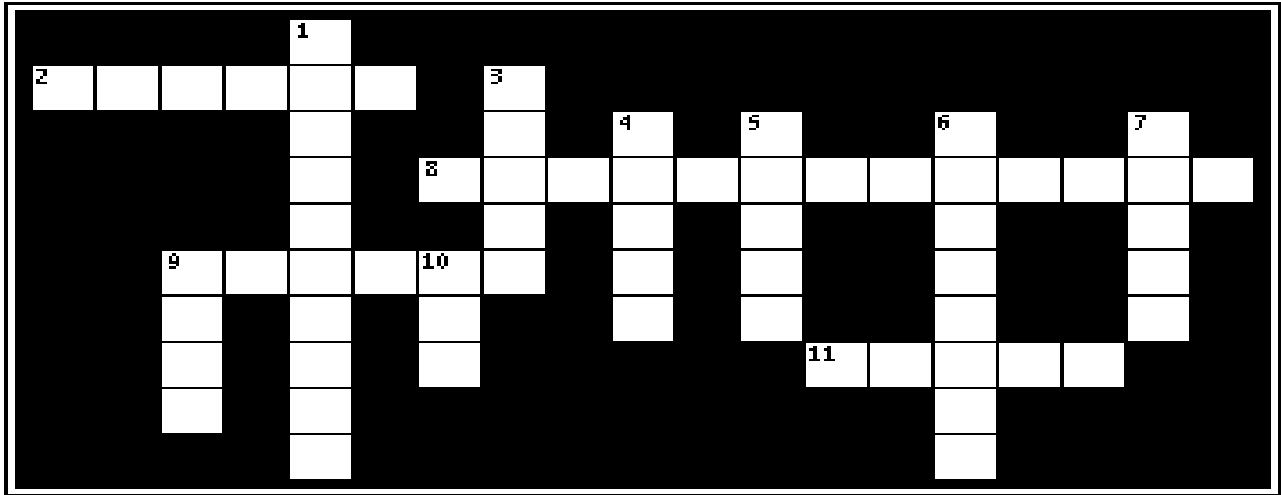

- 8 ACROSS "Coming out, He went to the _____, as He was accustomed, and His disciples also followed Him." **LUKE 22:39**
- 9 DOWN "When He came to the place, He said to them, '_____ that you may not enter into temptation.'" **LUKE 22:40**
- 9 ACROSS "And He was withdrawn from them about a stone's throw, and He knelt down and _____." **LUKE 22:41**
- 5 DOWN "...Father, if it is Your will, take this cup away from Me. Nevertheless not My will, but _____, be done.'" **LUKE 22:42**
- 4 DOWN "Then an _____ appeared to Him from heaven, strengthening Him." **LUKE 22:43**
- 3 DOWN "...His sweat became like great drops of _____ falling to the ground." **LUKE 22:44**
- 6 DOWN "When He rose up from prayer, and had come to His disciples, He found them _____ from sorrow." **LUKE 22:45**
- 1 DOWN "Then He said to them, 'Why do you sleep? Rise and pray, lest you enter into _____.'" **LUKE 22:46**
- 7 DOWN "And while He was still speaking, behold, a multitude; and he who was called Judas, one of the twelve, went before them and drew near to _____ to kiss Him." **LUKE 22:47**
- 10 DOWN "...one of them struck the servant of the high priest and cut off his right _____." **LUKE 22:50**
- 2 ACROSS "But Jesus answered and said, 'Permit even this.' And He touched his ear and _____ him." **LUKE 22:51**
- 11 ACROSS "Then Jesus said to the chief priests, captains of the temple, and the elders who had come to Him, 'Have you come out, as against a robber, with swords and clubs? When I was with you daily in the temple, you did not try to _____ Me. But this is your hour, and the power of darkness.'" **LUKE 22:52-53**

Bible Story 234

**JUDAS
BETRAYS
JESUS**

LUKE 22:47-53



"Judas betrays Jesus."
Luke 22:47-53

234. JUDAS BETRAYS JESUS

(LUKE 22:47-53)

MEMORY VERSE:

"By His knowledge My righteous Servant shall justify many, for He shall bear their iniquities." ISAIAH 53:11

CIRCLE THE CORRECT WORD:

1. "And while He was still speaking, behold, a multitude; and he who was called Judas, one of the twelve, went before them and drew near to Jesus to (**KISS, KILL**) Him." **LUKE 22:47**

TRUE OR FALSE:

2. When those around Him saw what was going to happen, they said to Him, "Lord, shall we strike with the hand?" **LUKE 22:49**
TRUE OR FALSE

CIRCLE THE CORRECT WORD:

3. "And one of them struck the servant of the high priest and cut off his right (**HAND, EAR**)."
LUKE 22:50

TRUE OR FALSE:

4. "But Jesus answered and said, 'Permit even this.' And He touched his ear and healed him."
LUKE 22:51
TRUE OR FALSE

CIRCLE THE CORRECT WORD:

5. "Then Jesus said to the chief priests, captains of the temple, and the elders who had come to Him, 'Have you come out, as against a (**FRIEND, ROBBER**), with swords and clubs?' " **LUKE 22:52**

TRUE OR FALSE:

6. "When I was with you daily in the temple, you did not try to seize Me. But this is your hour, and the power of darkness." **LUKE 22:53**
TRUE OR FALSE

234. JUDAS BETRAYS JESUS

(LUKE 22:47-53)

D B V R U O H T B G V U U J F
A K Q M B E K M P E F A V Y E
R K D E A R S W O R D V Z N K
K A V L U V S Z C I R C A A I
N T E D U T I T L U M A U M R
E D S O L Z M J D B B P E F T
S W M J U D A S T B B T F O S
S L C E P K O S B P Y A P N Y
O T S E I R P H G I H I T O Q
U A Z M M E V L E W T N O S D
G P T N A V R E S P R S N T C
F P L B C F A M B U S S I K M
B E T R A Y I N G Z G B I H P
K A U N C S U S E J I D R O L
D B T O S R E D L E K O J G O

BETRAYING
CAPTAINS
DARKNESS
EAR
ELDERS
HEALED

HIGH PRIEST
HOUR
JESUS
JUDAS
KISS
LORD

MULTITUDE
SERVANT
SON OF MAN
STRIKE
SWORD
TWELVE

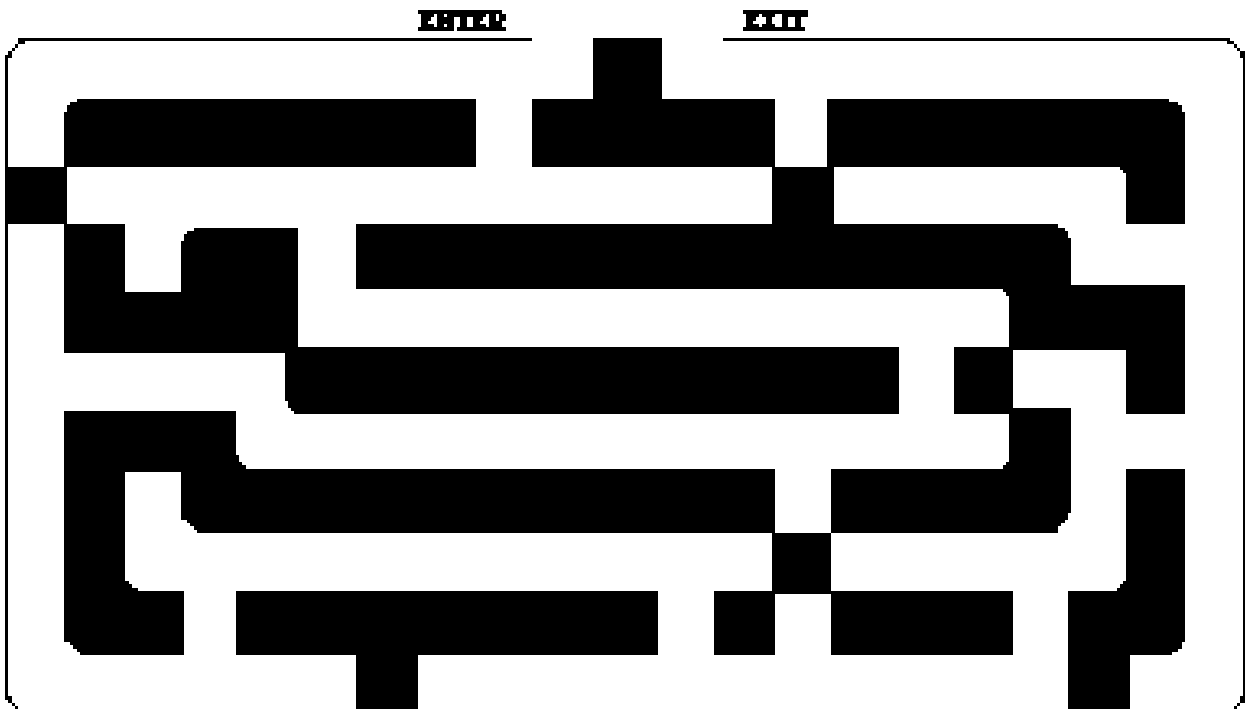

234. JUDAS BETRAYS JESUS

(LUKE 22:47-53)

MEMORY VERSE:

"By His knowledge My righteous Servant shall justify many, for He shall bear their iniquities." ISAIAH 53:11

FILL IN THE BLANK:

1. "And while He was still speaking, behold, a multitude; and he who was called Judas, one of the twelve, went before them and drew near to Jesus to _____ Him." **LUKE 22:47**

TRUE OR FALSE:

2. When those around Him saw what was going to happen, they said to Him, "Lord, shall we strike with the hand?" **LUKE 22:49**
TRUE OR FALSE

FILL IN THE BLANK:

3. "And one of them struck the servant of the high priest and cut off his right _____." **LUKE 22:50**

TRUE OR FALSE:

4. "But Jesus answered and said, 'Permit even this.' And He touched his ear and healed him." **LUKE 22:51**
TRUE OR FALSE

FILL IN THE BLANK:

5. "Then Jesus said to the chief priests, captains of the temple, and the elders who had come to Him, 'Have you come out, as against a _____, with swords and clubs?' " **LUKE 22:52**

TRUE OR FALSE:

6. "When I was with you daily in the temple, you did not try to seize Me. But this is your hour, and the power of darkness." **LUKE 22:53**
TRUE OR FALSE

234. JUDAS BETRAYS JESUS

(LUKE 22:47-53)

V D E W P A B C Y B F S A V K L O R D U
 I Q N P P F G C B D Y V D S G I K F J M
 O C Q N Y B R H W C A P T A I N S Y B J
 N U S K H T C A L L B U Y P P I W T J Q
 H J B S F I Z R E U D U S T N A V R E S
 I K N B E O G E E T F A M T S B I W H L
 U I A C O N H H W L H D U W O R U U T J
 A S Y D J M K M P F D G B B T G M G J T
 F S Q W T J K R W R B E I H W N F H Y W
 F B B K S W K Q A L I D R R I I O B R B
 T S Q I W T E N Z D E E S S H Y E V F M
 Q S O E S M R L O Y H W S J J A S S O L
 H M T N S K U I V H T T E T D R A U N U
 A J H P O G R L K E L L J Y U T D B O G
 S W O R D F E Y T E U A J K O E U H S C
 U T T I I H M M A I W H M E L B J B D V
 U A T Y A G N A K B T O O P S W P Q C U
 T A R B G D C A N O Q U G U O U K T G B
 T H E A L E D S U I N A D G R G S P S N
 D U R B W V V V N R I P O E U T J L Q H

BETRAYING
 CAPTAINS
 DARKNESS
 ELDERS
 HEALED

HIGH PRIEST
 HOUR
 JESUS
 JUDAS
 KISS

LORD
 MULTITUDE
 RIGHT EAR
 SERVANT

SON OF MAN
 STRIKE
 SWORD
 TWELVE

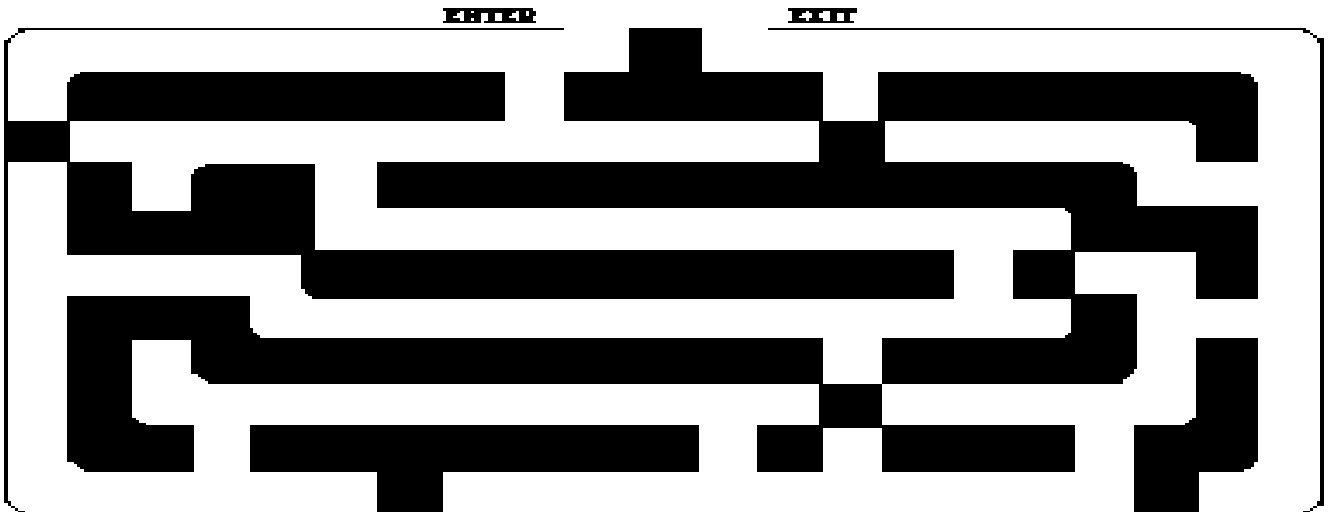

234. JUDAS BETRAYS JESUS

(LUKE 22:47-53)

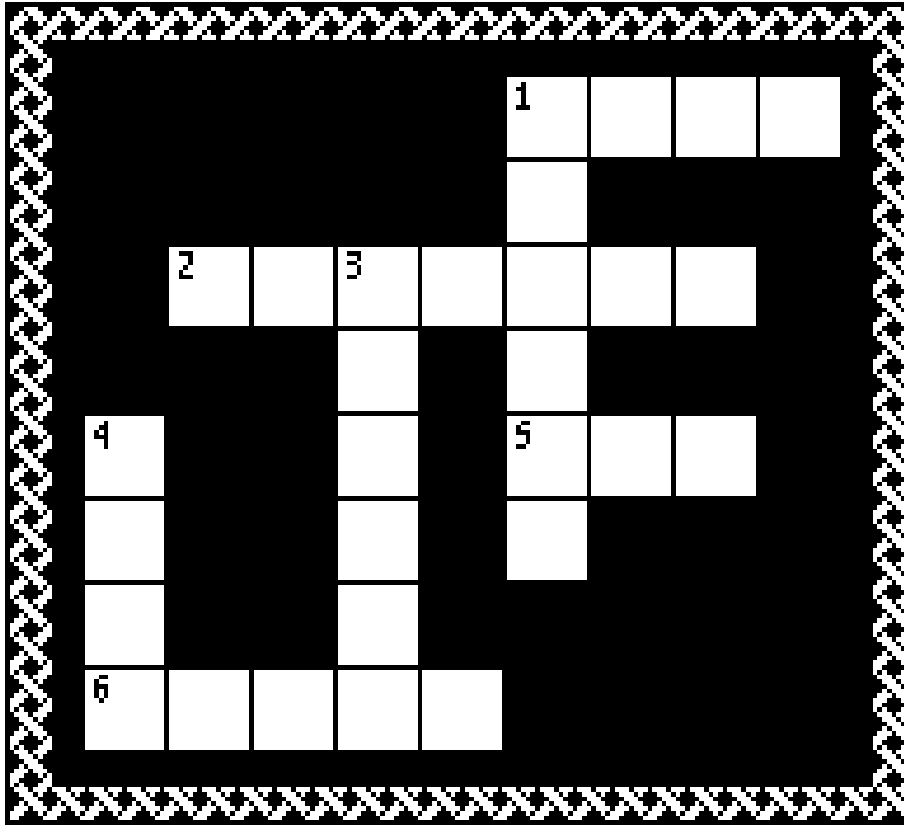

- 2 ACROSS "By His knowledge My righteous _____ shall justify many, for He shall bear their iniquities." **ISAIAH 53:11**
- 4 DOWN "And while He was still speaking, behold, a multitude; and he who was called Judas, one of the twelve, went before them and drew near to Jesus to _____ Him." **LUKE 22:47**
- 6 ACROSS "When those around Him saw what was going to happen, they said to Him, 'Lord, shall we strike with the _____?' " **LUKE 22:49**
- 5 ACROSS "And one of them struck the servant of the high priest and cut off his right _____." **LUKE 22:50**
- 1 DOWN "But Jesus answered and said, 'Permit even this.' And He touched his ear and _____ him." **LUKE 22:51**
- 3 DOWN "Then Jesus said to the chief priests, captains of the temple, and the elders who had come to Him, 'Have you come out, as against a _____, with swords and clubs?' " **LUKE 22:52**
- 1 ACROSS "When I was with you daily in the temple, you did not try to seize Me. But this is your _____, and the power of darkness." **LUKE 22:53**

Bible Story 235

PETER'S DENIAL

JOHN 18:15-18, 25-27

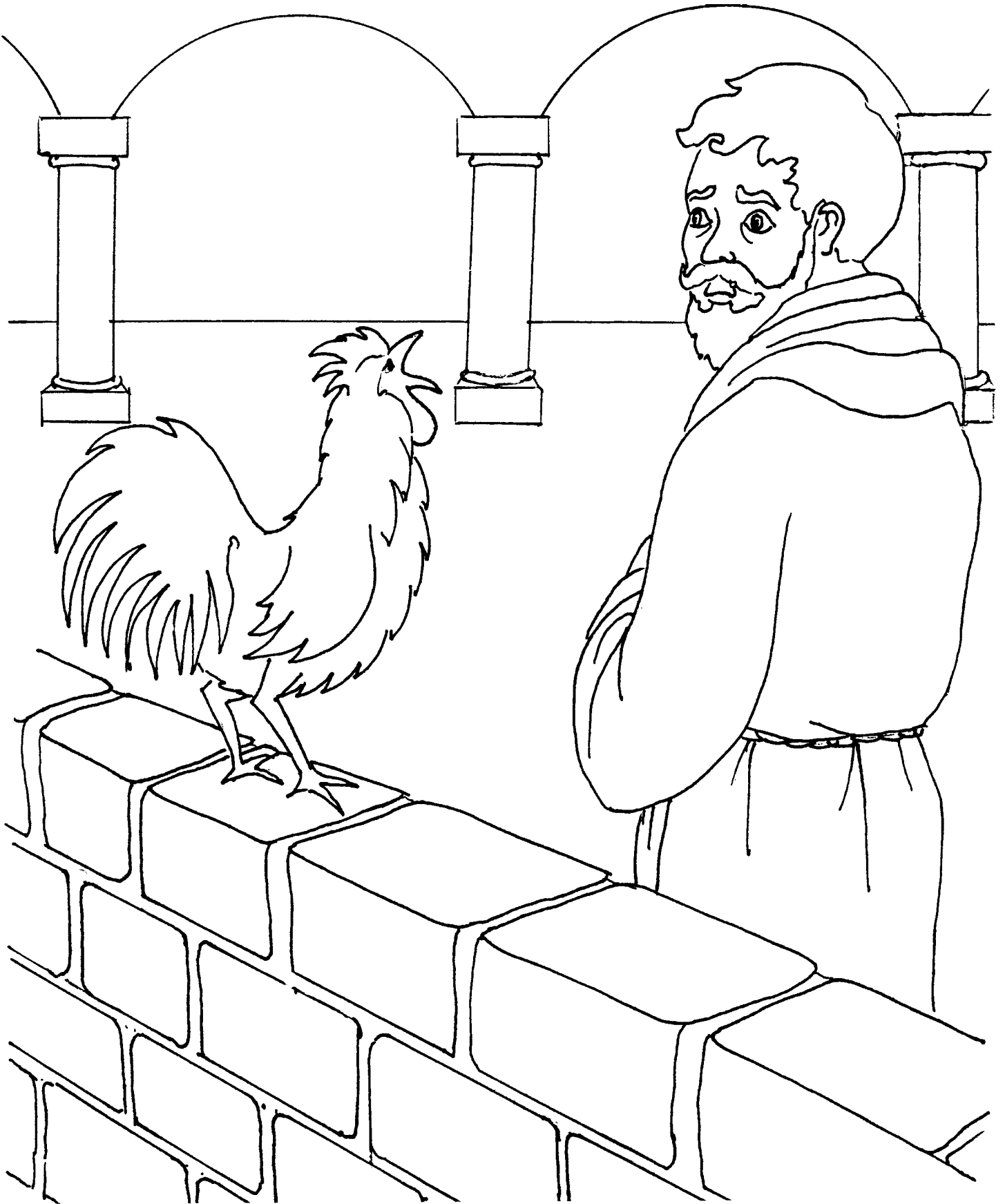

"After denying knowing Jesus for a third time, Peter heard the rooster crow." *John 18;15 – 18, 25 – 27*

235. PETER'S DENIAL

(JOHN 18:15-18, 25-27)

MEMORY VERSE:

"Therefore whoever confesses Me before men, him I will also confess before My Father who is in heaven." MATTHEW 10:32

TRUE OR FALSE:

1. "And Simon Peter followed Jesus, and so did another disciple..." **JOHN 18:15**
TRUE OR FALSE

CIRCLE THE CORRECT WORDS:

2. "...Now that disciple was known to the high priest, and went with Jesus into the (COURTYARD, HOUSE) of the high priest." **JOHN 18:15**
3. "But Peter stood at the door (INSIDE, OUTSIDE)..." **JOHN 18:16**

TRUE OR FALSE:

4. "Then the other disciple, who was known to the high priest, went out and spoke to her who kept the door, and brought Peter in." **JOHN 18:16**
TRUE OR FALSE

CIRCLE THE CORRECT ANSWER:

5. "Then the servant girl who kept the door said to Peter, 'You are not also one of this man's disciples, are you?' He said, 'I (AM, AM NOT).'" **JOHN 18:17**

TRUE OR FALSE:

6. "And the servants and officers who had made a fire of coals stood there, for it was cold, and they warmed themselves. And Peter stood with them and warmed himself." **JOHN 18:18**
TRUE OR FALSE
7. "...Therefore they said to him, 'You are not also one of his disciples, are you?' He denied it and said, 'I am not!' " **JOHN 18:25**
TRUE OR FALSE

CIRCLE THE CORRECT WORDS:

8. "One of the servants of the high priest, a relative of him whose ear Peter had cut off, said, 'Did I not see you in the (STORE, GARDEN) with Him?' " **JOHN 18:26**
9. "Peter then denied again; and immediately a (ROOSTER, DUCK) crowed." **JOHN 18:27**

235. PETER'S DENIAL

(JOHN 18:15-18, 25-27)

L F N L A B P K G J I I J V J
B Y I A T S T P P D B B F S B
F E S S E S W G S B G I R L J
L B L R I E E O F F I C E R S
T D I P P M W I O O R M Y U H
H F V O I J O A R D E W O R C
R F D R A C D N R P W F T B T
E B U E O M S R P M H O W H J
E E U V I O B I A E E G U U N
Y H A I D N S K D Y T D I Q E
H T D T Y G E T T L T E G H D
B L D A S O H D E O G R R T R
O U W L M V J O W R T E U P A
I W J E S U S O I U K P H O G
R Q T R U S Y R H I W K B L C

COURTYARD
CROWED
DENIED
DISCIPLE
DOOR
FIRE

GARDEN
GIRL
HIGH PRIEST
JESUS
OFFICERS

RELATIVE
ROOSTER
SIMON PETER
THREE
WARMED



235. PETER'S DENIAL

(JOHN 18:15-18, 25-27)

MEMORY VERSE:

"Therefore whoever confesses Me before men, him I will also confess before My Father who is in heaven." MATTHEW 10:32

TRUE OR FALSE:

1. "And Simon Peter followed Jesus, and so did another disciple..." **JOHN 18:15**
TRUE OR FALSE

FILL IN THE BLANKS:

2. "...Now that disciple was known to the high priest, and went with Jesus into the _____ of the _____." **JOHN 18:15**
3. "But Peter stood at the door _____..." **JOHN 18:16**

TRUE OR FALSE:

4. "Then the other disciple, who was known to the high priest, went out and spoke to her who kept the door, and brought Peter in." **JOHN 18:16**
TRUE OR FALSE

FILL IN THE BLANKS:

5. "Then the servant girl who kept the door said to Peter, 'You are not also one of this man's disciples, are you?' He said, 'I _____.'" **JOHN 18:17**

TRUE OR FALSE:

6. "And the servants and officers who had made a fire of coals stood there, for it was cold, and they warmed themselves. And Peter stood with them and _____ warmed himself." **JOHN 18:18**
TRUE OR FALSE

7. "...Therefore they said to him, 'You are not also one of his disciples, are you?' He denied it and said, 'I am not!'" **JOHN 18:25**

TRUE OR FALSE

FILL IN THE BLANKS:

8. "One of the servants of the high priest, a relative of him whose ear Peter had cut off, said, 'Did I not see you in the _____ with Him?'" **JOHN 18:26**
9. "Peter then denied again; and immediately a _____ crowed." **JOHN 18:27**

235. PETER'S DENIAL

(JOHN 18:15-18, 25-27)

O D P Y I R V K U H Y C D G Y H Q N Y U Z V C W R
 S Y Z I P E G S H Y C J E S U S A R W V W I P E J
 K I V E N M Y Y I G R P I W B L E M C W W W L U D
 L B U F R H Q B P M O L V K C B G I N A V A N U E
 D L D B B I D F B B W O D O J R A F R T T A B Y Q
 F O W L C Y F L R U E P E R N O S J G I H M I O W
 A U R E T S O O R V D D M I A I T Q V Z W H V L D
 B P E A N Y O L E E H Q N L M Y G E I V S L G P U
 R W E E T M O B R Z F J B O B A T E B B R A U Z A
 B C B Z S B B I N I Q J N D R W N R B B V Z B P B
 E P D C E P P Q A U G P A D L H B P U M B Y J Z C
 W R V L I R Z S I U E T E S L J K G T O B E W B Q
 G F N W R Y S S P T B N N B D S L G S S C B S F B
 F M P C P R T O E I H C S A N R D L T H D G F P H
 Z E Y A H E V R Q B M B P J V V O Y O J E Z Z T C
 A T G Z G B G E F Q G V W L K R H T Y L I S Z S H
 D I S C I P L E R B Q D J J A J E P T B N B E A L
 N L N S H V W Z C V W I H T B D Y S T B E E S W U
 S M W D P T D P S R E C I F F O Q V G K D W G I A
 H E Y G C O B E G B G M N B W B K E F N G G Y L W
 U Z Z P B J A S E M I T E E R H T N I P P B M V A
 S I U C C D G U O W B O F V K V G J Y F E T B U R
 Y I G V O Q S V W Y W O G Q Y C O A M H I D O A M
 J D F O B L A F J U D F I O Y G J H R J N P L G E
 N Z R U P P U I V K I U E V E O M N A K A T F O D

COURTYARD
 CROWD
 DENIED
 DISCIPLE
 DOOR
 FIRE

GARDEN
 HIGH PRIEST
 JESUS
 OFFICERS
 RELATIVE

ROOSTER
 SERVANT GIRL
 SIMON PETER
 THREE TIMES
 WARMED



235. PETER'S DENIAL

(JOHN 18:15-18, 25-27)

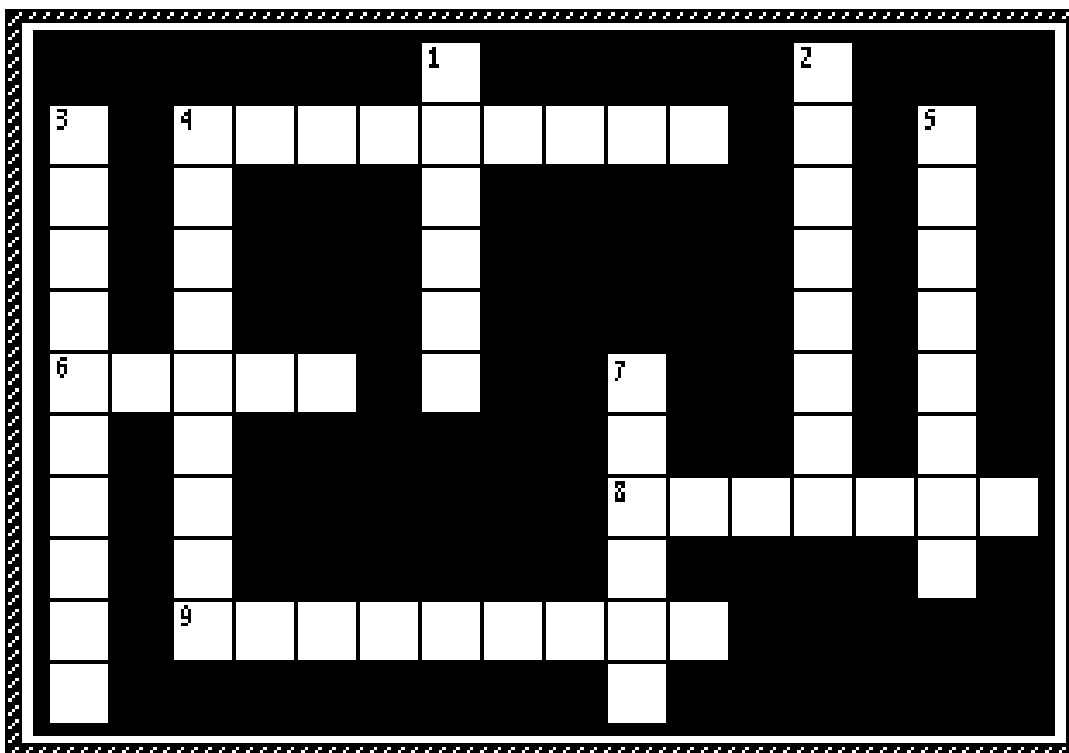

- 4 ACROSS "Therefore whoever _____ Me before men, him I will also confess before My Father who is in heaven." **MATTHEW 10:32**
- 5 DOWN "And Simon Peter _____ Jesus, and so did another disciple..." **JOHN 18:15**
- 4 DOWN "...Now that disciple was known to the high priest, and went with Jesus into the _____ of the high priest." **JOHN 18:15**
- 6 ACROSS "But _____ stood at the door outside..." **JOHN 18:16**
- 3 DOWN "Then the other disciple, who was known to the _____ _____, went out and spoke to her who kept the door, and brought Peter in." **JOHN 18:16**
- 9 ACROSS "Then the servant girl who kept the door said to Peter, 'You are not also one of this man's _____, are you?' He said, 'I am not.'" **JOHN 18:17**
- 2 DOWN "And the servants and _____ who had made a fire of coals stood there, for it was cold, and they warmed themselves. And Peter stood with them and warmed himself." **JOHN 18:18**
- 1 DOWN "...Therefore they said to him, 'You are not also one of his disciples, are you?' He _____ it and said, 'I am not!'" **JOHN 18:25**
- 7 DOWN "One of the servants of the high priest, a relative of him whose ear Peter had cut off, said, 'Did I not see you in the _____ with Him?'" **JOHN 18:26**
- 8 ACROSS "Peter then denied again; and immediately a _____ crowed." **JOHN 18:27**

Bible Story 236

**THE
SANHEDRIN,
HEROD &
PILATE**

LUKE 22:66-23:25

236. THE SANHEDRIN, HEROD & PILATE

(LUKE 22:66-23:25)

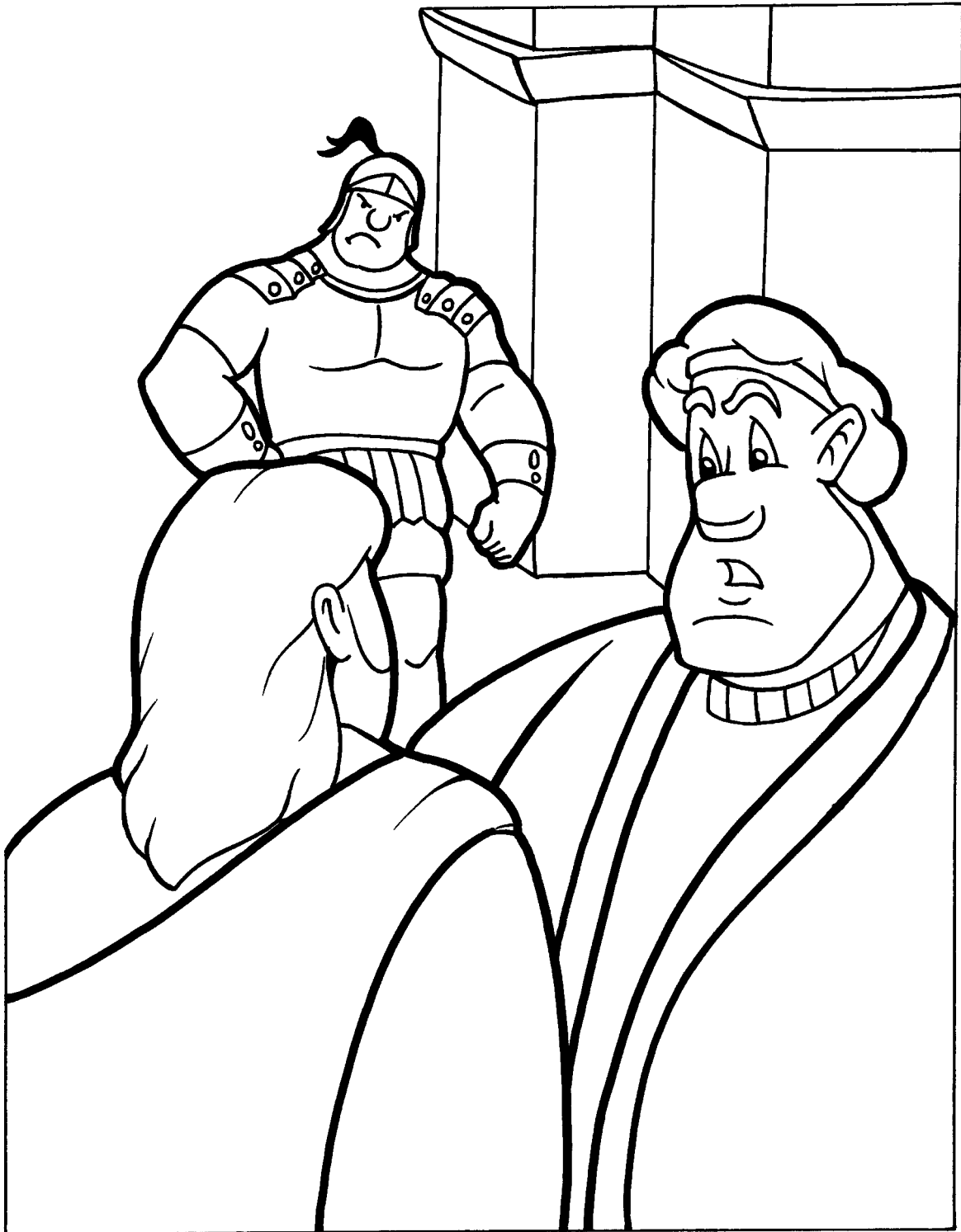

"And the whole multitude of them arose, and led him unto Pilate. And they began to accuse him, saying, We found this *fellow* perverting the nation, and forbidding to give tribute to Caesar, saying that he himself is Christ a King."

LUKE 23:1-2

236. THE SANHEDRIN, HEROD & PILATE

(LUKE 22:66-23:25)

MEMORY VERSE:

"Hereafter the Son of Man will sit on the right hand of the power of God." LUKE 22:69

As soon as it was day...

TRUE OR FALSE:

1. "...the elders of the people, both chief priests and scribes came together and led Him into their council." LUKE 22:66

TRUE OR FALSE

2. "'If You are the Christ, tell us.' But He said to them, 'If I tell you, you will by no means believe. And if I also ask you, you will by no means answer Me or let Me go. Hereafter the Son of Man will sit on the right hand of the power of God.'" LUKE 22:67-69

TRUE OR FALSE

CIRCLE THE CORRECT WORD:

3. "Then they all said, 'Are You then the Son of God?' And He said to them, 'You (**RIGHTLY**, **WRONGLY**) say that I am.'" LUKE 22:70

TRUE OR FALSE:

4. "Then the whole multitude of them arose and led Him to Pilate." LUKE 23:1

TRUE OR FALSE

5. "So Pilate asked Him, saying, 'Are You the King of the Jews?' And He answered him and said, 'It is as you say.'" LUKE 23:2

TRUE OR FALSE

CIRCLE THE CORRECT WORDS:

6. "Pilate said to the chief priests and the crowd, 'I find no (**FAULT**, **TRUTH**) in this Man.'" LUKE 23:4

7. "...as soon as he knew that He belonged to Herod's jurisdiction, he sent Him to Herod, who was also in (**BETHLEHEM**, **JERUSALEM**) at that time." LUKE 23:7

TRUE OR FALSE:

8. Then He questioned Him with many words, and He answered him everything. LUKE 23:9

TRUE OR FALSE

CIRCLE THE CORRECT WORDS:

9. "And the chief priests and scribes stood and vehemently (**APPLAUDED**, **ACCUSED**) Him. Then Herod, with his men of war, treated Him with contempt and (**MOCKED**, **WALKED**) Him, arrayed Him in a gorgeous robe, and sent Him back to Pilate." LUKE 23:10-11

10. "Pilate, therefore wishing to (**RELEASE**, **IMPRISON**) Jesus, again called out to them. But they shouted, saying, 'Crucify Him, crucify Him!'" LUKE 23:20-21

11. "So Pilate gave sentence that it should be as (**THEY**, **HE**) requested." LUKE 23:24

236. THE SANHEDRIN, HEROD & PILATE

(LUKE 22:66-23:25)

V B N E B N O F A Q A Y H W J
 C Q A M Y K S O N O F M A N W
 A D S S I F N B U B A Q T K S
 L J E D A O I P I L A T E I S
 O I L S T N J C U U U U T E I
 Z C P W U B H E U J E D R P A
 M T U M A C L E S R N O R I G
 F C T T O H C I D U C G W Y W
 M S N S L C H A C R S F P B G
 Q J C I B B K T T N I O N B N
 S W D R H V I E T K U N B P I
 Q Y R H I E U Q D S Q O B P K
 V J A C Z B R H D M B S C Y A
 E L D E R S E O D J N Q C B B
 P T Z Q Z I A S D T A T D O U

ACCUSED
 CHRIST
 COUNCIL
 CRUCIFY
 ELDERS

HEROD
 JESUS
 KING
 MOCKED
 PILATE

SANHEDRIN
 SCRIBES
 SON OF GOD
 SON OF MAN

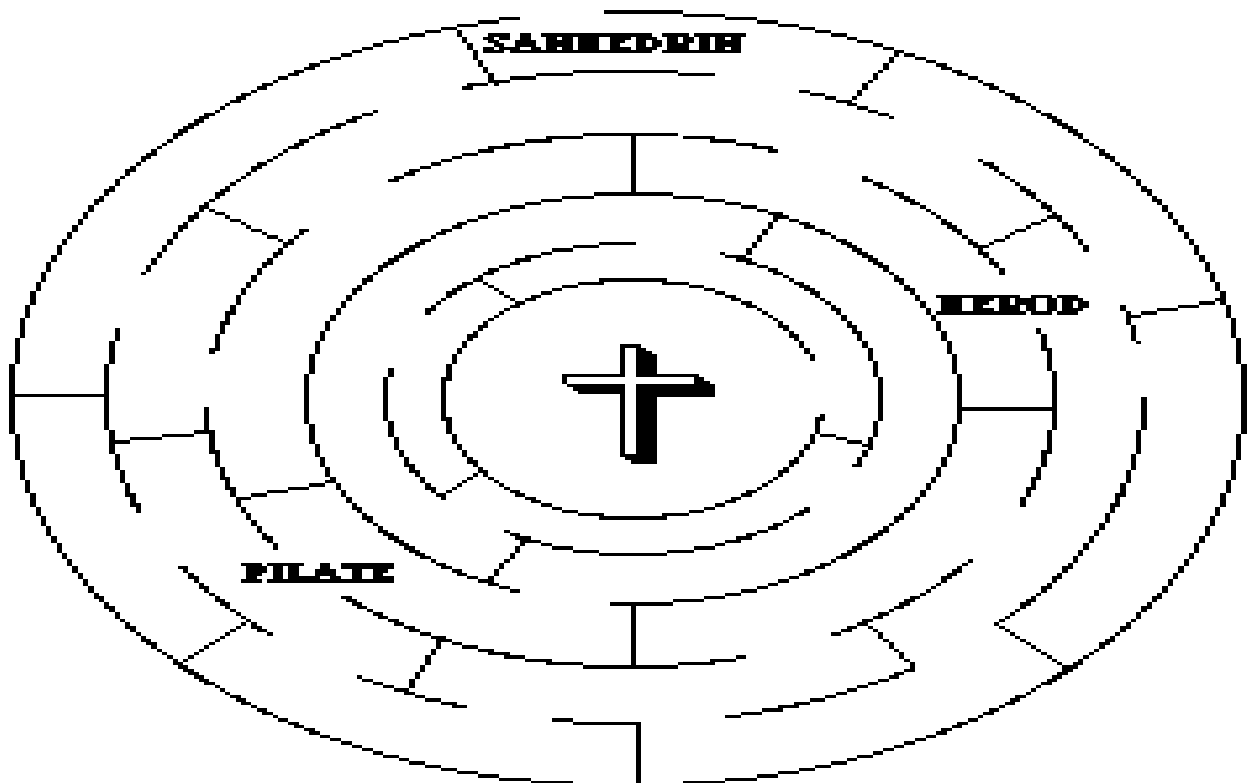

236. THE SANHEDRIN, HEROD & PILATE

(LUKE 22:66-23:25)

MEMORY VERSE:

"Hereafter the Son of Man will sit on the right hand of the power of God." LUKE 22:69

As soon as it was day...

TRUE OR FALSE:

1. "...the elders of the people, both chief priests and scribes came together and led Him into their council."
LUKE 22:66

TRUE OR FALSE

2. "'If You are the Christ, tell us.' But He said to them, 'If I tell you, you will by no means believe. And if I also ask you, you will by no means answer Me or let Me go. Hereafter the Son of Man will sit on the right hand of the power of God.'" LUKE 22:67-69

TRUE OR FALSE

FILL IN THE BLANK:

3. "Then they all said, 'Are You then the Son of God?' And He said to them, 'You _____ say that I am.'" LUKE 22:70

TRUE OR FALSE:

4. "Then the whole multitude of them arose and led Him to Pilate." LUKE 23:1

TRUE OR FALSE

5. "So Pilate asked Him, saying, 'Are You the King of the Jews?' And He answered him and said, 'It is as you say.'" LUKE 23:2

TRUE OR FALSE

FILL IN THE BLANKS:

6. "Pilate said to the chief priests and the crowd, 'I find _____ in this Man.'" LUKE 23:4

7. "...as soon as he knew that He belonged to Herod's jurisdiction, he sent Him to _____, who was also in Jerusalem at that time." LUKE 23:7

TRUE OR FALSE:

8. Then He questioned Him with many words, and He answered him everything. LUKE 23:9

TRUE OR FALSE

FILL IN THE BLANKS:

9. "And the chief priests and scribes stood and vehemently _____ Him. Then Herod, with his men of war, treated Him with contempt and _____ Him, arrayed Him in a gorgeous robe, and sent Him back to Pilate." LUKE 23:10-11

10. "Pilate, therefore wishing to _____ Jesus, again called out to them. But they shouted, saying, 'Crucify Him, crucify Him!'" LUKE 23:20-21

11. "So Pilate gave sentence that it should be as _____ requested." LUKE 23:24

236. THE SANHEDRIN, HEROD & PILATE

(LUKE 22:66-23:25)

C O U N C I L E U R Z O G C P
 H U L K A H T I Z G A N F M I
 A T P F T M E B V I U I D D L
 S M Y F I C U R C B S P E O A
 T O N A M F O N O S C R K G T
 I E C H R I S T F D R I C F E
 S M M K M B B B R U I E O O U
 E B C S Z P B P K A B S M N H
 V Y N O M I T S E T E T Y O A
 S N C M J C G P K V S S K S E
 M O D E S U C C A B E J I P C
 C E E L I L A G Y O F J N O N
 S A N H E D R I N U P Y G E A
 Z B V O S D S U S E J T Q A I
 L U Z S R E D L E V T H D Y Z

ACCUSED
 CHRIST
 COUNCIL
 CRUCIFY

ELDERS
 HEROD
 JESUS
 KING

MOCKED
 PRIESTS
 SANHEDRIN
 SCRIBES

SON OF MAN
 SON OF GOD
 TESTIMONY

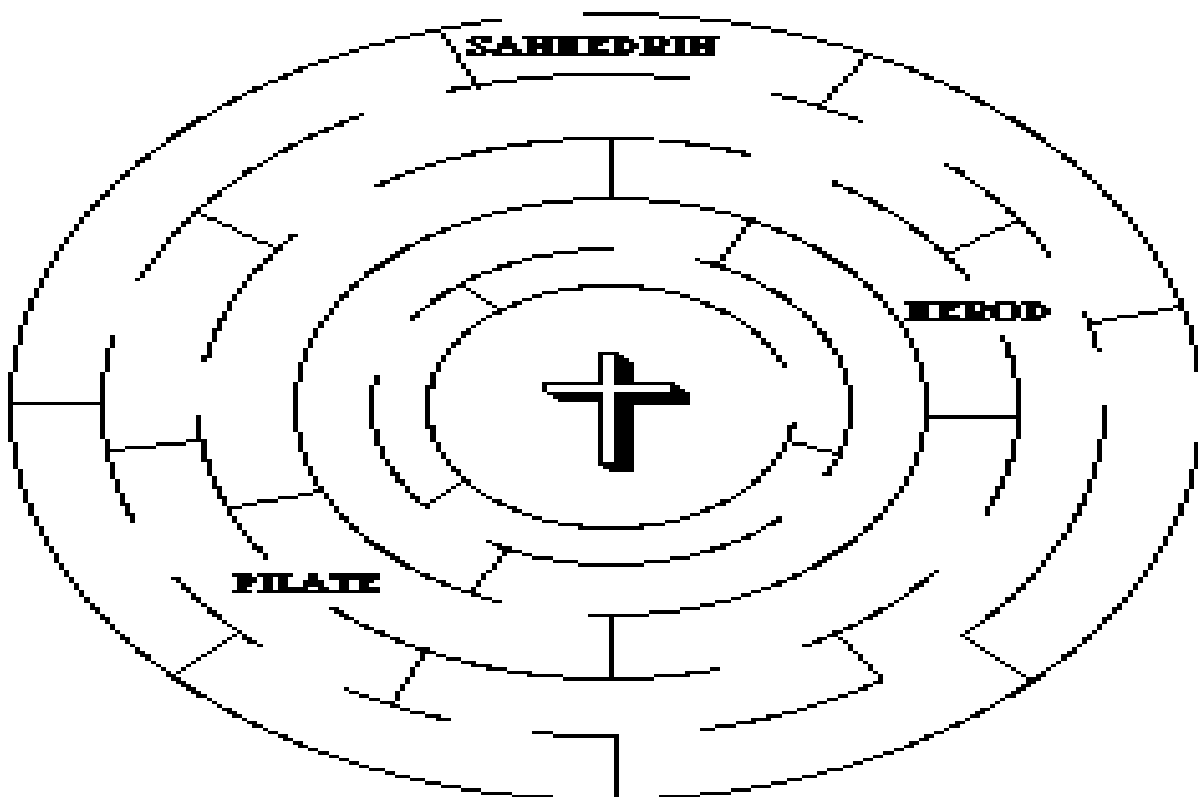

236. THE SANHEDRIN, HEROD & PILATE

(LUKE 22:66-23:25)

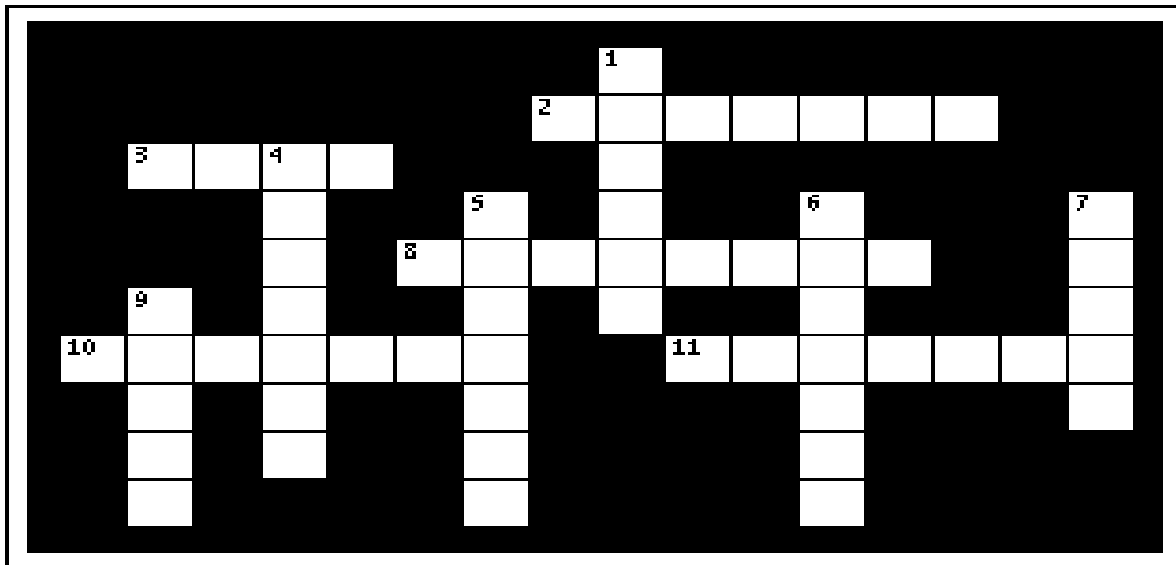

- 11 ACROSS "...the elders of the people, both chief priests and scribes came together and led Him into their ____." **LUKE 22:66**
- 10 ACROSS "'If You are the Christ, tell us.' But He said to them, 'If I tell you, you will by no means _____. And if I also ask you, you will by no means answer Me or let Me go. Hereafter the Son of Man will sit on the right hand of the power of God.'" **LUKE 22:67-69**
- 2 ACROSS "Then they all said, 'Are You then the Son of God?' And He said to them, 'You ____ say that I am.'" **LUKE 22:70**
- 1 DOWN "Then the whole multitude of them arose and led Him to ____." **LUKE 23:1**
- 3 ACROSS "So Pilate asked Him, saying, 'Are You the ____ of the Jews?' And He answered him and said, 'It is as you say.'" **LUKE 23:2**
- 7 DOWN "Pilate said to the chief priests and the crowd, 'I find no ____ in this Man.'" **LUKE 23:4**
- 9 DOWN "...as soon as he knew that He belonged to Herod's jurisdiction, he sent Him to _____, who was also in Jerusalem at that time." **LUKE 23:7**
- 4 DOWN "Then He questioned Him with many words, but He answered him ____." **LUKE 23:9**
- 6 DOWN "And the chief priests and scribes stood and vehemently ____ Him. Then Herod, with his men of war, treated Him with contempt and mocked Him, arrayed Him in a gorgeous robe, and sent Him back to Pilate." **LUKE 23:10-11**
- 5 DOWN "Pilate, therefore wishing to ____ Jesus, again called out to them. But they shouted, saying, 'Crucify Him, crucify Him!'" **LUKE 23:20-21**
- 8 ACROSS "So Pilate gave ____ that it should be as they requested." **LUKE 23:24**

Bible Story 237

JESUS IS CRUCIFIED

LUKE 23:26-49

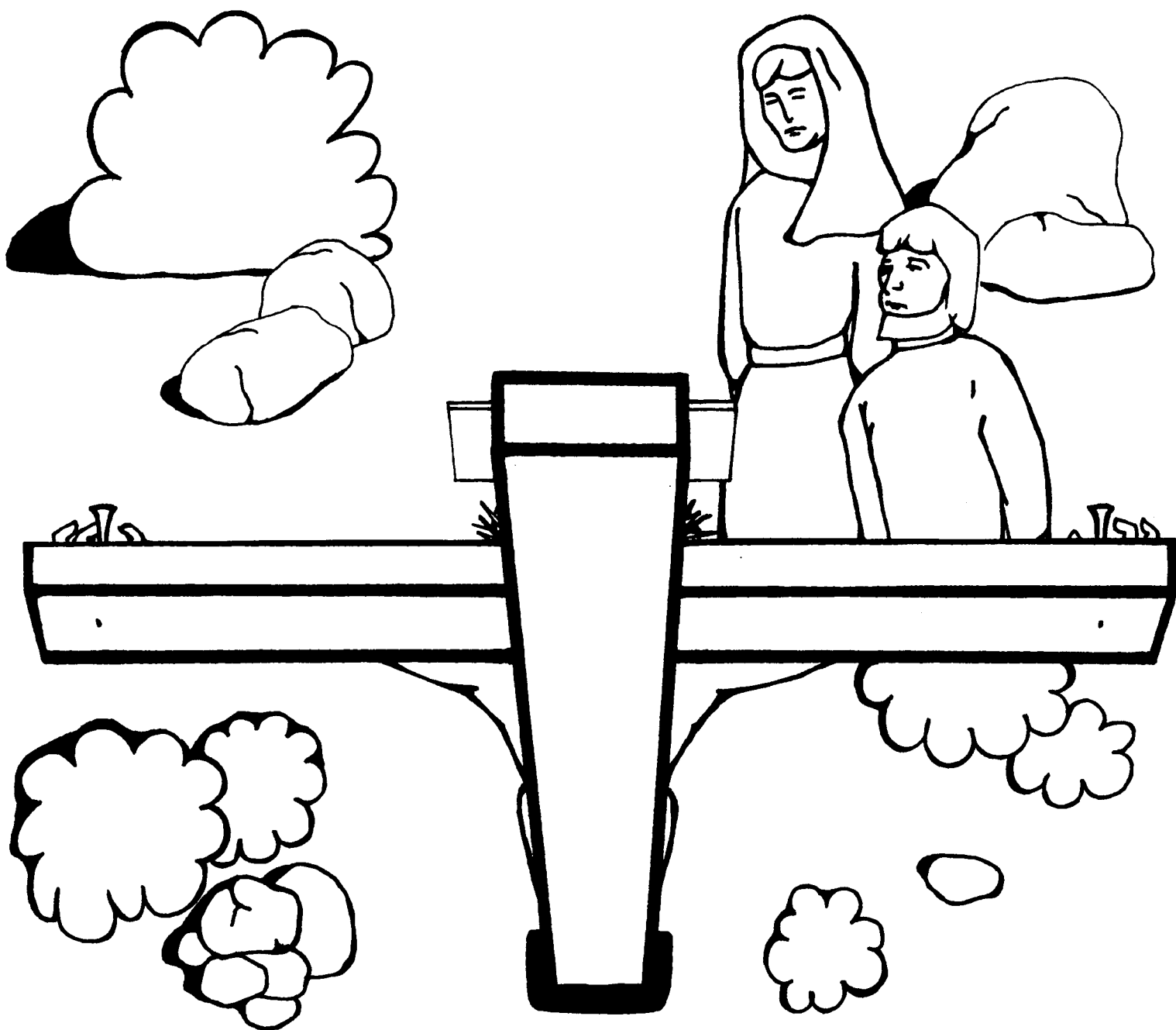

"Jesus is crucified."
Luke 23:26-49

237. JESUS IS CRUCIFIED

(LUKE 23:26-49)

MEMORY VERSE:

"But He was wounded for our transgressions, He was bruised for our iniquities; the chastisement for our peace was upon Him, and by His stripes we are healed." ISAIAH 53:5

CIRCLE THE CORRECT WORD:

1. "Now as they led Him away, they laid hold of a certain man, (**SAUL, SIMON**) a Cyrenian, who was coming from the country, and on him they laid the cross that he might bear it after Jesus." **LUKE 23:26**

TRUE OR FALSE:

2. There were also eight others, criminals, led with Him to be put to death. **LUKE 23:32**
TRUE OR FALSE
3. "And when they had come to the place called Calvary, there they crucified Him, and the criminals, one on the right hand and the other on the left." **LUKE 23:33**

TRUE OR FALSE

FILL IN THE BLANK:

4. "Then Jesus said, 'Father, _____ them, for they do not know what they do' ..." **LUKE 23:34**

TRUE OR FALSE:

5. "...And they divided His garments and cast lots." **LUKE 23:34**
TRUE OR FALSE
6. "And the people stood looking on. But even the rulers with them sneered, saying, 'He saved others; let Him save Himself if He is the Christ, the chosen of God.'" **LUKE 23:35**

TRUE OR FALSE

7. "And the soldiers also mocked Him, coming and offering Him sour wine, and saying, 'If You are the King of the Jews, save Yourself.'" **LUKE 23:36-37**

TRUE OR FALSE

UNDERLINE THE CORRECT ANSWER:

8. "Then one of the criminals who were hanged blasphemed Him, saying, 'If You are the Christ, ____.'" **LUKE 23:39**
a. Save Yourself and us.
b. Tell them to bring me some sour wine too.

CIRCLE THE CORRECT WORDS:

9. "But the other, answering, rebuked him, saying, 'Do you not even fear God, seeing you are under the same condemnation? And we indeed justly, for we receive the due reward for our deeds; but this Man has done (**NOTHING, EVERYTHING**) wrong.'" **LUKE 23:40-41**
10. "Then he said to Jesus, 'Lord, (**REMEMBER, FORGET**) me when You come into Your kingdom.' And Jesus said to him, 'Assuredly, I say to you, today you will be with Me in Paradise.'" **LUKE 23:42-43**

TRUE OR FALSE:

11. "And when Jesus had cried out with a loud voice, He said, 'Father, "into Your hands I commit My spirit."' And having said this, He breathed His last." **LUKE 23:46**

TRUE OR FALSE

237. JESUS IS CRUCIFIED

(LUKE 23:26-49)

F E K J T R O Z O P U U P P M
I S K T A I F S J J W F Y N S
N G Q E N L V H J H D I B E Z
I D J J R S E V I G R O F S F
S E D E S N A E L C W B D I P
H P B Z P T B M E S Y G R D G
E Z B Z I F S B A G I Y C A K
D C R K Q A V D E I D N G R B
F T S I R H C S U S E J S A U
H C B C D D O O L B P D R P B
A Q T I R I P S W E Z E G B C
W I B T J Y M S L E W K N O R
C R U C I F I E D V B C G F O
B W E I Q Y A V Z A M O Z L S
P Z F O B M A L B S W M J L S

BLOOD
CLEANSED
CROSS
CRUCIFIED
DIED

FINISHED
FORGIVE
JESUS CHRIST
LAMB
MOCKED

PARADISE
SAVE
SINS
SPIRIT

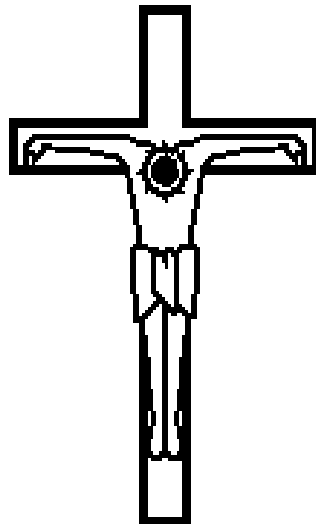

237. JESUS IS CRUCIFIED

(LUKE 23:26-49)

MEMORY VERSE:

"But He was wounded for our transgressions, He was bruised for our iniquities; the chastisement for our peace was upon Him, and by His stripes we are healed." ISAIAH 53:5

FILL IN THE BLANK:

1. "Now as they led Him away, they laid hold of a certain man, _____ a Cyrenian, who was coming from the country, and on him they laid the cross that he might bear it after Jesus." **LUKE 23:26**

TRUE OR FALSE:

2. There were also eight others, criminals, led with Him to be put to death. **LUKE 23:32**
TRUE OR FALSE
3. "And when they had come to the place called Calvary, there they crucified Him, and the criminals, one on the right hand and the other on the left." **LUKE 23:33**
TRUE OR FALSE

FILL IN THE BLANK:

4. "Then Jesus said, 'Father, _____ them, for they do not know what they do' ..." **LUKE 23:34**

TRUE OR FALSE:

5. "...And they divided His garments and cast lots." **LUKE 23:34**
TRUE OR FALSE

FILL IN THE BLANKS:

6. "And the people stood looking on. But even the rulers with them _____, saying, 'He saved others; let Him save Himself if He is the Christ, the chosen of God.'" **LUKE 23:35**
7. "And the soldiers also _____ Him, coming and offering Him sour wine, and saying, 'If You are the King of the Jews, save Yourself.'" **LUKE 23:36-37**

UNDERLINE THE CORRECT ANSWER:

8. "Then one of the criminals who were hanged blasphemed Him, saying, 'If You are the Christ, ____.'" **LUKE 23:39**
- a. Save Yourself and us.
- b. Tell them to bring me some sour wine too.

FILL IN THE BLANKS:

9. "But the other, answering, rebuked him, saying, 'Do you not even fear God, seeing you are under the same condemnation? And we indeed justly, for we receive the due reward for our deeds; but this Man has done _____ wrong.'" **LUKE 23:40-41**
10. "Then he said to Jesus, 'Lord, _____ me when You come into Your kingdom.' And Jesus said to him, 'Assuredly, I say to you, today you will be with Me in _____.'" **LUKE 23:42-43**

TRUE OR FALSE:

11. "And when Jesus had cried out with a loud voice, He said, 'Father, "into Your hands I commit My spirit."' And having said this, He breathed His last." **LUKE 23:46**
TRUE OR FALSE

237. JESUS IS CRUCIFIED

(LUKE 23:26-49)

W Y R V B E Z Y Z P B J P E W K B D B C B D S E F P G H G M
P H E V I G R O F Y B B J V K D N T B M Q B S F R F S P P H
P U E B T P Z Y B B U B H A I B O B A P F Y F S N D L U F B
W Q M B Y Z K O P D B P Q R J K B M V O G K J A Y H C V Q Y
Q A U Q L C C F J R C Z O L S B B O B D A K S G M D Y L K A
L S W Y I C T V H C B Y A W U A L C O E E J G Q Z F D R G O
T S J E O Q I B G G M Y W J E T P K B A M S R F U W T R B M
A I N L V I O S E R D O V U A W M E V Y M M N H I Y L E Q B
U R S N D E I F I C U R C O V L C D Z U A V A A K S V V L H
U L E V Q W T V U G L J M E D A C B A H O W S W E K P U J N
H S Z D Z Z A M W N S F F P Q P V G U A K Z F U N L T V V B
E J K Q E K N A D G V A S T E P Z E E E C F N I M T C P U V
R F B T U E R Z W Z R H W C N A B I F E S I D A R A P I B I
S F Z A A K M S Y J C A U S R G F B P C Y I T K C E J R E U
A O F Q N Q P E P P M H D C Y B O B T N U Z Q E D F I F A S
V P H F M J I H D N L Z S H Y V B O O A D T C Y N Y P V F S
E E T S I R H C S U S E J U D Q S P D I Y M D B Y R K Q I A
J O N H F B Q M Z U B Y J E J D M P N S G G Y T J N D B M L
S O G P G I D B W O B N H C I V O U I Z H G R I D L A I I Y
T C B J F B N S B F A J Q N P S A Z J S T E Q O V M Y P O J
A F G T H R J I M L C T O Q T M T V J N I R P W C A S O Q H
Z B R B A B Q V S L W P E L V C M F Y C I H T H U B G R H W
S B Q S W K R O W H J L W K R Z Z R T Z D U B A E T M A U Z
D Y I S B E I J U M E J E D F L J K H O P V K E A R S N I S
J A T O N E M E N T U D B D E U S K O B G Y I P U O D V N A
Q N P R P F L J F S K C K O J T M L G R C Y J Q T N B K H P
I M H C E J S E I Z O V S K O M B Y F P J R D T E B T R P B
K H Z I S T T A B F I T B Q U O B R Y J N T I F B V L W U I
T L I A G E F W G P T W H K G E P G Q P H E E V O E A Y Y C
D D V M D J A L Y G E H P L F M C I D Q E U D I O F B B N N

ATONEMENT
BLOOD
CLEANSED
CROSS
CRUCIFIED
DIED

FINISHED
FORGIVE
GOOD SHEPHERD
JESUS CHRIST
LAMB

MOCKED
PARADISE
REDEEMED
SAVE
SINS

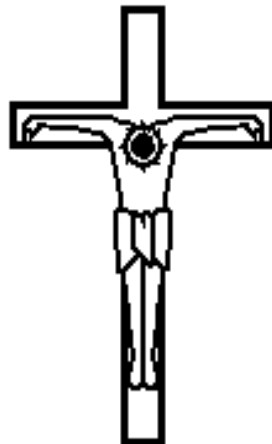

237. JESUS IS CRUCIFIED

(LUKE 23:26-49)

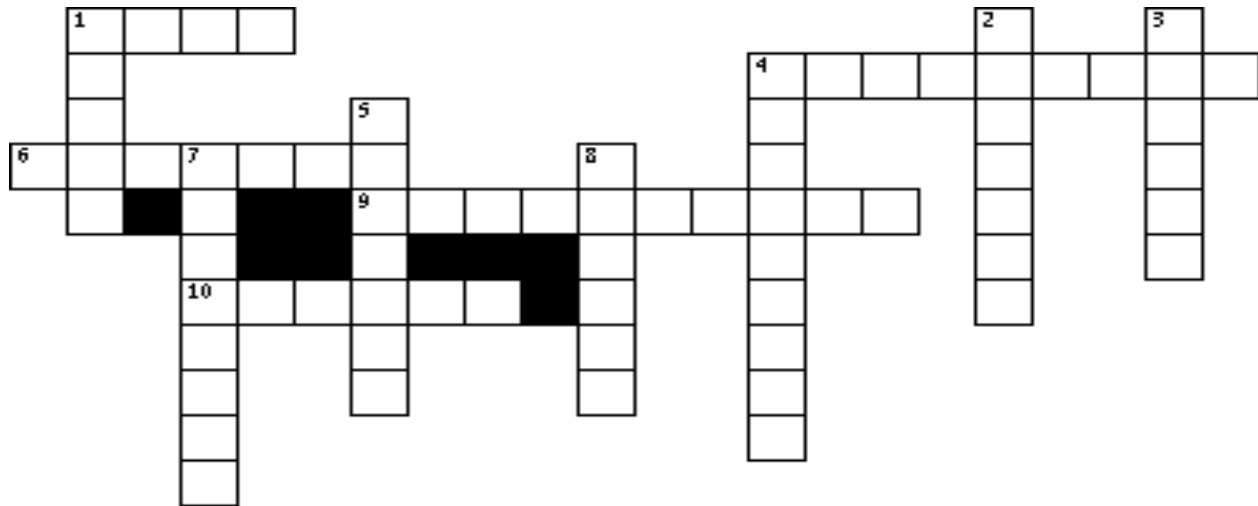

- 3 DOWN "But He was wounded for our transgressions, He was bruised for our iniquities; the chastisement for our peace was upon Him, and by His stripes we are ____." **ISAIAH 53:5**
- 1 DOWN "Now as they led Him away, they laid hold of a certain man, ____ a Cyrenian, who was coming from the country, and on him they laid the cross that he might bear it after Jesus." **LUKE 23:26**
- 4 DOWN "There were also two others, ____, led with Him to be put to death." **LUKE 23:32**
- 4 ACROSS "And when they had come to the place called Calvary, there they ____ Him, and the criminals, one on the right hand and the other on the left." **LUKE 23:33**
- 6 ACROSS "Then Jesus said, 'Father, ____ them, for they do not know what they do' ..." **LUKE 23:34**
- 7 DOWN "...And they divided His ____ and cast lots." **LUKE 23:34**
- 1 ACROSS "And the people stood looking on. But even the rulers with them sneered, saying, 'He saved others; let Him ____ Himself if He is the Christ, the chosen of God.'" **LUKE 23:35**
- 10 ACROSS "And the soldiers also ____ Him, coming and offering Him sour wine, and saying, 'If You are the King of the Jews, save Yourself.'" **LUKE 23:36-37**
- 9 ACROSS "Then one of the criminals who were hanged ____ Him, saying, 'If You are the Christ, save Yourself and us.'" **LUKE 23:39**
- 5 DOWN "But the other, answering, ____ him, saying, 'Do you not even fear God, seeing you are under the same condemnation?'" **LUKE 23:40**
- 2 DOWN "Then he said to Jesus, 'Lord, remember me when You come into Your ____.'" And Jesus said to him, 'Assuredly, I say to you, today you will be with Me in Paradise.'" **LUKE 23:42-43**
- 8 DOWN "And when Jesus had cried out with a loud voice, He said, 'Father, "into Your hands I commit My ____.'" And having said this, He breathed His last." **LUKE 23:46**

Bible Story 238

**JESUS
IS RISEN!**

Mark 16:1-11

238. JESUS IS RISEN!

(MARK 16:1-11)



"And entering into the sepulchre, they saw a young man sitting on the right side, clothed in a long white garment; and they were affrighted. And he saith unto them, be not affrighted: Ye seek Jesus of Nazareth, which was crucified: he is risen; he is not here: behold the place where they laid him." **MARK 16:5-6**

238. JESUS IS RISEN!

(MARK 16:1-11)

MEMORY VERSE:

"He is risen! He is not here. See the place where they laid Him." MARK 16:6

TRUE OR FALSE:

1. "Now when the Sabbath was past, Mary Magdalene, Mary the mother of James, and Salome bought spices, that they might come and anoint Him." **MARK 16:1**
TRUE OR FALSE
2. "Very early in the morning, on the first day of the week, they came to the tomb when the sun had risen." **MARK 16:2**
TRUE OR FALSE
3. But when they looked up, they saw that the stone had not been rolled away- for it was very large. **MARK 16:4**
TRUE OR FALSE

CIRCLE THE CORRECT WORDS:

4. "And entering the (**TEMPLE, TOMB**), they saw a young man clothed in a long white robe sitting on the right side." **MARK 16:5**
5. "Go, tell His disciples-and Peter - that He is going before you into (**EGYPT, GALILEE**); there you will see Him, as He said to you." **MARK 16:7**
6. "And they went out quickly and fled from the tomb, for they trembled and were amazed. And they said nothing to anyone, for they were (**AFRAID, EXCITED**)."
MARK 16:8

TRUE OR FALSE:

7. "Now when He rose early on the first day of the week, He appeared first to Mary Magdalene, out of whom He had cast seven demons." **MARK 16:9**
TRUE OR FALSE

UNDERLINE THE CORRECT ANSWER:

8. "She went and told those who had been with Him, as they wept and mourned. And when they heard that He was alive and had been seen by her..." **MARK 16:10-11**
 - a. they believed
 - b. they did not believe

238. JESUS IS RISEN

(MARK 16:1-11)

M K H C O J E P B B D J Y B F
 O P Z V E U W E O E O S Y M E
 R Z Y S A D E V E C B B D O M
 N Y U T W B H T A B B A S T O
 I S D E I F I C U R C E J V L
 N Y N W V J B A P A Q A N R A
 G O J H M H K R T N F V I A S
 K J T P F Q S L C Q K R P F M
 O E N E L A D G A M Y R A M B
 I F P J S S E C I P S D T I D
 T A T N I O N A S L L Q N E D
 E S T O N E U W C B W E E J B
 M O T H E R O F J A M E S O B
 J H L H W O H J H D K N I U B
 K A J Q D E Z A M A I R R G A

AFRAID
 AMAZED
 ANOINT
 CRUCIFIED
 JESUS

MAN
 MARY MAGDALENE
 MORNING
 MOTHER OF JAMES
 RISEN

SABBATH
 SALOME
 SPICES
 STONE
 TOMB

START HERE →

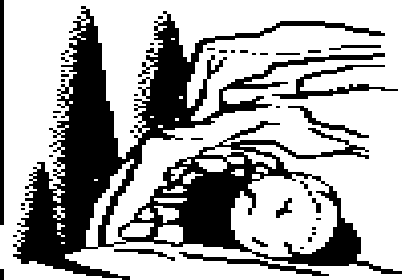
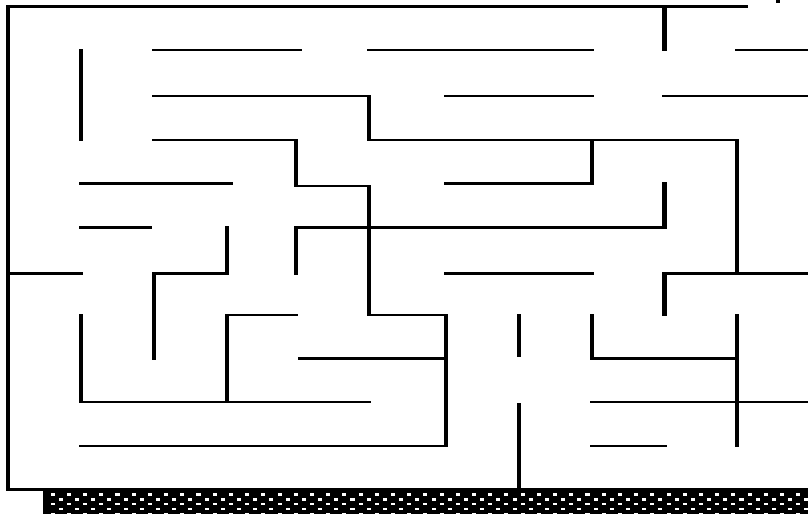

**HE IS RISEN!
 HE IS NOT HERE**

238. JESUS IS RISEN!

(MARK 16:1-11)

MEMORY VERSE:

"He is risen! He is not here. See the place where they laid Him." MARK 16:6

FILL IN THE BLANKS:

1. "Now when the Sabbath was past, Mary Magdalene, Mary the mother of James, and Salome bought _____, that they might come and anoint Him." **MARK 16:1**
2. "Very early in the morning, on the _____ day of the week, they came to the tomb when the sun had risen." **MARK 16:2**

TRUE OR FALSE:

3. But when they looked up, they saw that the stone had not been rolled away- for it was very large.
MARK 16:4

TRUE OR FALSE

FILL IN THE BLANKS:

4. "And entering the _____, they saw a young man clothed in a long white robe sitting on the right side." **MARK 16:5**
5. "Go, tell His disciples-and Peter - that He is going before you into _____; there you will see Him, as He said to you." **MARK 16:7**
6. "And they went out quickly and fled from the tomb, for they trembled and were amazed. And they said nothing to anyone, for they were _____." **MARK 16:8**

TRUE OR FALSE:

7. "Now when He rose early on the first day of the week, He appeared first to Mary Magdalene, out of whom He had cast seven demons." **MARK 16:9**

TRUE OR FALSE

UNDERLINE THE CORRECT ANSWER:

8. "She went and told those who had been with Him, as they wept and mourned. And when they heard that He was alive and had been seen by her..." **MARK 16:10-11**
 - a. they believed
 - b. they did not believe

238. JESUS IS RISEN

(MARK 16:1-11)

C Y S Z Q B U T J K O L S H K T B M Z Q T Y U D F B I A N I
 E F S Z J I T H W R A U E J J J N Z B N T E M D H G F E Z U
 U K R O I T T T S E K W J D F Y H B T R C A E R D B L M F Q
 B T V W E A D T S D J Q M Y O U N G M A N E S M R I B B N H
 M G N N C L M R I E E N G U Y R A I P U M Q Z J S V K Z B C
 B E O H T B D A S N U Z O O T D N Z Z B P U P L M S M U A C
 U T G Q C Z Q U R C N I A L W C O F F B M T J P C M I I D N
 S Y D I J Z S R A Y U S V M U G I Z V I L V H O B M O T P U
 Y G P L W N C W G V T V S O A S N B F F C H T A B B A S U B
 Y M K H Y K U P W C D H P U G Q T D H W S S D L U B U J B S
 R Q S T J O J N A C L U E I H U B B N L G E C T R I B L I U
 F H P Y T B B B F H U U T M B M A B E J E T U D S R W M B N
 H V P O N H S B U R F A E I O J U U E B Y B U E J K V P R E
 E V R A A F M C T E L D W M V T V Y M B B N S I L Q B B Q S
 L G B V S V J D O M Y D B B O Q H E J K W B Y F P Y G E I B
 M S O C L I T W M Q H W H R S L A E Q J I Y J I B C P C J T
 G N A A P O A K M N B T J W U L A E R K A Z G C N Z H H L I
 M B S F U N A I J A O L Y G B J E S V O C A A U S A B M J L
 B K L L R H U E K Y R A K T H T I J E B F B K R L B H B V E
 P K K O T A E P G M I Y P K U W S A V M L J R C P R C I R I
 M O W Z N I I I H A R O M N E S I R V S P U A P H V O V R A
 W J V M D U N D G S F A G A Q K G V L E A E B M L Z V M K K
 N Q J F R A Q Y D V Y P K W G M J K A C I D N N E Y N T J Q
 G S B M A F B B V Y B A G I T D P U I I E K Y R Q S J Q S Y
 K P W Q Z F N B B K D D P U P L A O L P Y G N A U E L V F R
 B M E S E T A P G W F Y S M L U Z L R S A C M P I H D U Q B
 Y B L Q M Q Y P C L B S O F J G F Z E B Q M Q L C Z R G V T
 K B V V D H Q Y Z W E M T O B C B B U N A N P Y C C Z B B P
 P O D P W A U F H W H U W E J V B A U Y E Q L M M S B D R K
 U H D B Q U Q O K Z T B I P H U K M C R O R J T R G Y O B Z

AFRAID
 AMAZED
 ANOINT
 CRUCIFIED
 JESUS

MARY MAGDALENE
 MARY THE MOTHER OF JAMES
 RISEN
 SABBATH
 SALOME

SPICES
 STONE
 TOMB
 YOUNG MAN

START HERE →

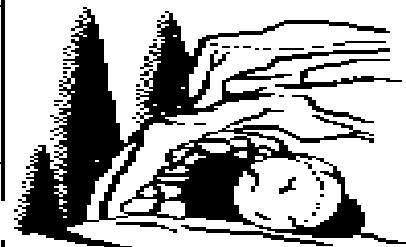
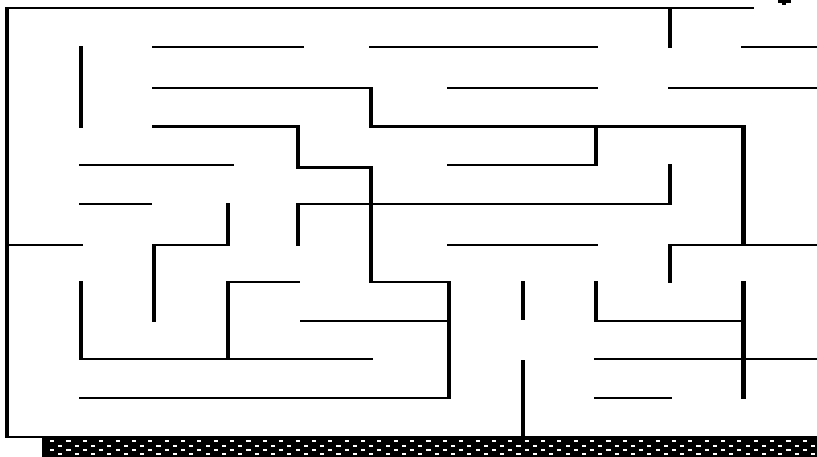

**HE IS RISEN!
 HE IS NOT HERE**

238. JESUS IS RISEN!

(MARK 16:1-11)

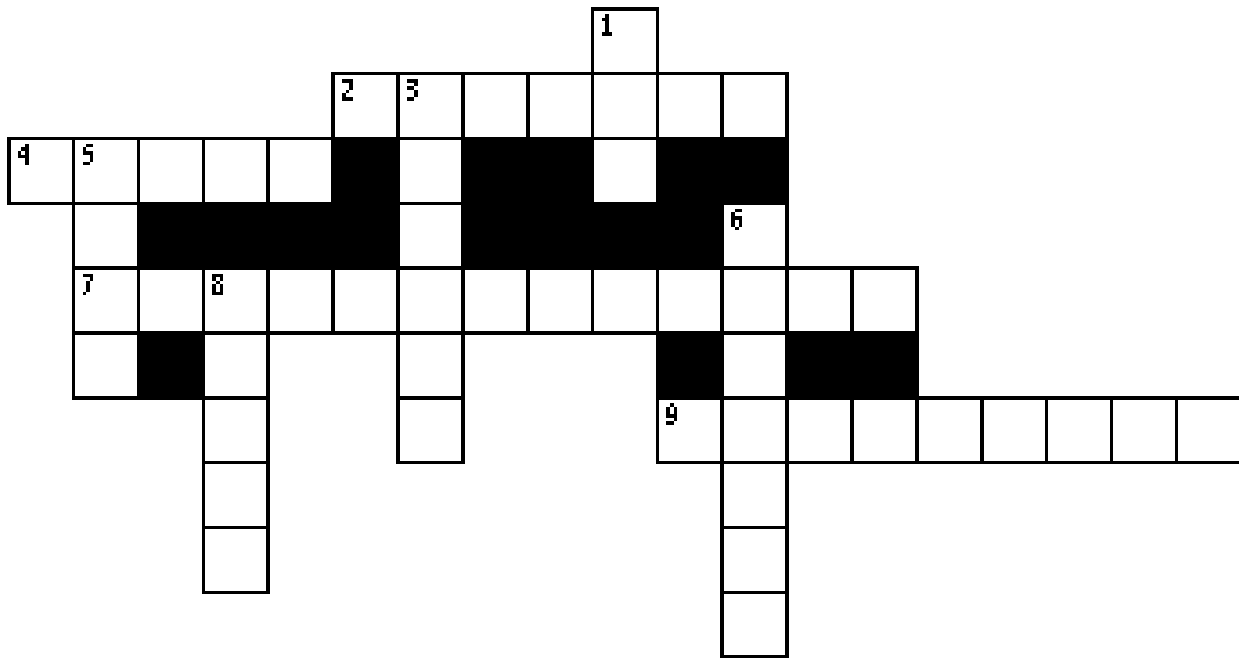

- 2 ACROSS "Now when the _____ was past, Mary Magdalene, Mary the mother of James, and Salome bought spices, that they might come and anoint Him." **MARK 16:1**
- 5 DOWN "Very early in the morning, on the first day of the week, they came to the _____ when the sun had risen." **MARK 16:2**
- 4 ACROSS "But when they looked up, they saw that the _____ had been rolled away- for it was very large." **MARK 16:4**
- 1 DOWN "And entering the tomb, they saw a young _____ clothed in a long white robe sitting on the right side." **MARK 16:5**
- 8 DOWN "He is _____! He is not here. See the place where they laid Him." **MARK 16:6**
- 9 ACROSS "Go, tell His _____-and Peter - that He is going before you into Galilee; there you will see Him, as He said to you." **MARK 16:7**
- 3 DOWN "And they went out quickly and fled from the tomb, for they trembled and were amazed. And they said nothing to anyone, for they were _____." **MARK 16:8**
- 7 ACROSS "Now when He rose early on the first day of the week, He appeared first to _____, out of whom He had cast seven demons." **MARK 16:9**
- 6 DOWN "She went and told those who had been with Him, as they wept and mourned. And when they heard that He was alive and had been seen by her they did not _____." **MARK 16:10-11**

Bible Story 239

**PETER & JOHN
VISIT JESUS' TOMB**

JOHN 20:1-10

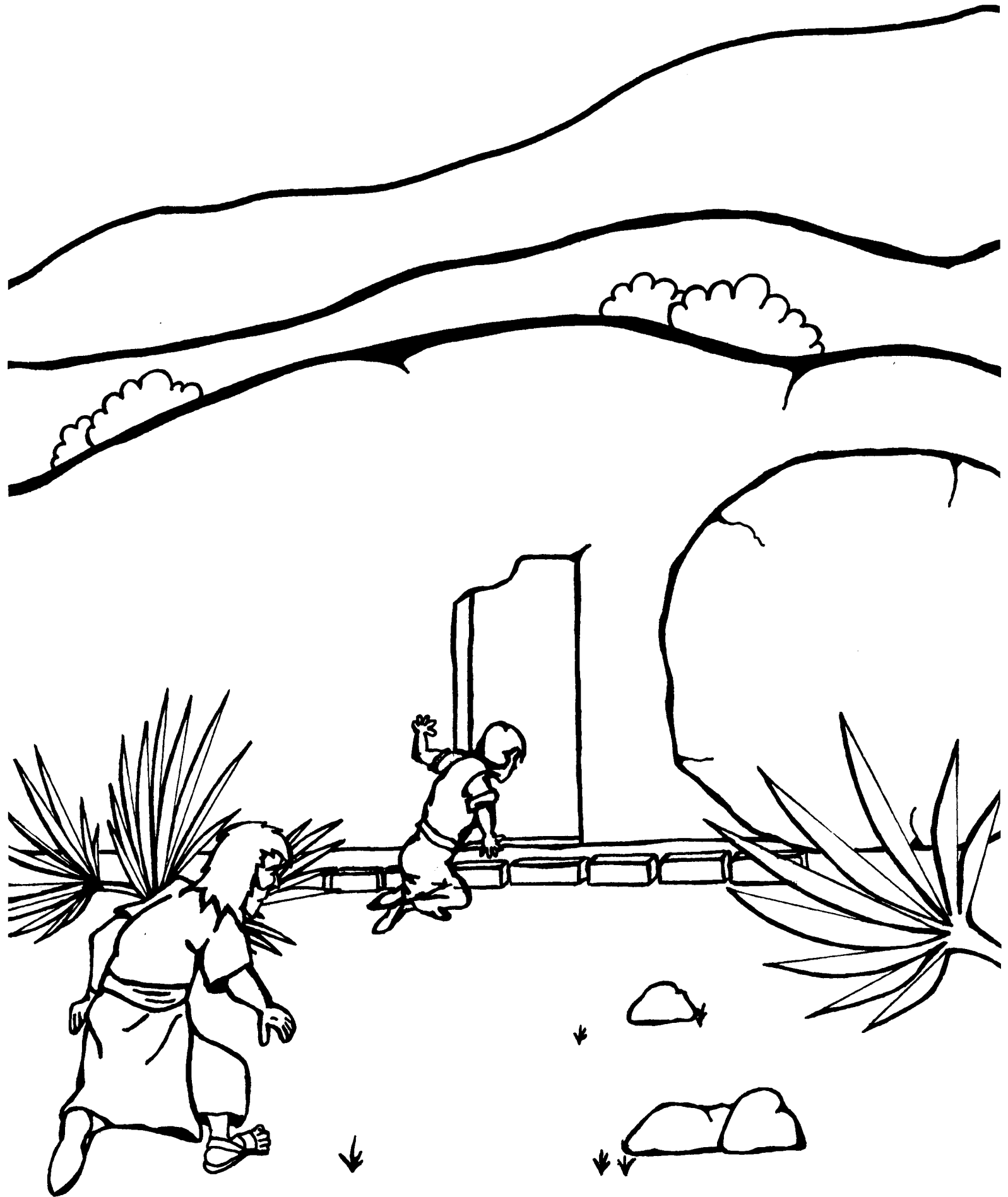

"Peter and John visit Jesus' tomb." *John 20:1 – 10*

239. PETER AND JOHN VISIT JESUS' TOMB

(JOHN 20:1-10)

MEMORY VERSE:

"For He taught His disciples and said to them, 'The Son of Man is being delivered into the hands of men, and they will kill Him. And after He is killed, He will rise the third day.' " MARK 9:31

TRUE OR FALSE:

1. "On the first day of the week Mary Magdalene came to the tomb early, while it was still dark, and saw that the stone had been taken away from the tomb." **JOHN 20:1**
TRUE OR FALSE
2. "Then she ran and came to Simon Peter, and to the other disciple, whom Jesus loved, and said to them, 'They have taken away the Lord out of the tomb, and we do not know where they have laid Him.'" **JOHN 20:2**
TRUE OR FALSE
3. Peter therefore went out, and the other disciple, but were not going to the tomb. **JOHN 20:3**
TRUE OR FALSE

CIRCLE THE CORRECT WORDS:

4. "So they both ran together, and the other disciple outran Peter and came to the tomb (**FIRST, SECOND**)."
JOHN 20:4
5. "And he, stooping down and looking in, saw the linen cloths lying there; yet he (**DID, DID NOT**) go in."
JOHN 20:5
6. "Then Simon Peter came, following him, and went into the tomb; and he saw the linen cloths lying there, and the (**CROWN, HANDKERCHIEF**) that had been around His head, not lying with the linen cloths, but folded together in a place by itself."
JOHN 20:6-7

FILL IN THE BLANK:

7. "Then the other disciple, who came to the tomb first, went in also; and he saw and _____."
JOHN 20:8

TRUE OR FALSE:

8. "For as yet they did not know the Scripture, that He must rise again from the dead." **JOHN 20:9**
TRUE OR FALSE
9. "Then the disciples went away again to their own homes." **JOHN 20:10**
TRUE OR FALSE

239. PETER AND JOHN VISIT JESUS' TOMB

(JOHN 20:1-10)

S R B B C B L O H L P V S S U
C C L B M O B J Z J J M J U B
R G L C R B B F Y C H F H H M
I R M D L O E L P I C S I D O
P G R E T E P N O M I S Q P T
T N S U B I P A N R I S E E O
U G Z M B T Z H J V Q S O V E
R Z F D A E Y N E N I L E A P
E E N E L A D G A M Y R A M L
Y J P L C D E D L O F W W A T
P P D E V E I L E B O U I R C
Y N G S W J Y A T T A D E L S
H A N D K E R C H I E F B W C
B U K V J N A R P W W D K J H
D O B R S U S E J H S T O N E

BELIEVED
DISCIPLE
FOLDED
HANDKERCHIEF
JESUS

LAI
LINEN
LORD
MARY MAGDALENE
RAN

RISE
SCRIPTURE
SIMON PETER
STONE
TOMB



239. PETER AND JOHN VISIT JESUS' TOMB

(JOHN 20:1-10)

MEMORY VERSE:

"For He taught His disciples and said to them, 'The Son of Man is being delivered into the hands of men, and they will kill Him. And after He is killed, He will rise the third day.' " MARK 9:31

FILL IN THE BLANKS:

1. "On the first day of the week Mary Magdalene came to the tomb early, while it was still dark, and saw that the _____ had been taken away from the tomb." JOHN 20:1
2. "Then she ran and came to Simon Peter, and to the other disciple, whom Jesus loved, and said to them, 'They have taken away the _____ out of the tomb, and we do not know where they have laid Him.' "
JOHN 20:2

TRUE OR FALSE:

3. Peter therefore went out, and the other disciple, but were not going to the tomb. JOHN 20:3
TRUE OR FALSE

FILL IN THE BLANKS:

4. "So they both ran together, and the other disciple outran Peter and came to the tomb _____." JOHN 20:4
5. "And he, stooping down and looking in, saw the linen cloths lying there; yet he _____ go in." JOHN 20:5
6. "Then _____ came, following him, and went into the tomb..." JOHN 20:6
7. "...and he saw the linen cloths lying there, and the _____ that had been around His head, not lying with the linen cloths, but folded together in a place by itself." JOHN 20:7
8. "Then the other disciple, who came to the tomb first, went in also; and he saw and _____." JOHN 20:8

TRUE OR FALSE:

9. "For as yet they did not know the Scripture, that He must rise again from the dead." JOHN 20:9
TRUE OR FALSE
10. "Then the disciples went away again to their own homes." JOHN 20:10
TRUE OR FALSE

239. PETER AND JOHN VISIT JESUS' TOMB

(JOHN 20:1-10)

T J O G J B E L A Y G E P E L F E B I Y C I U B T T O M A U
 W S N E N I L S W P K J J V W K M P K Q Z P V K J E S U S N
 F T O B T P F T L Y B K H A K D B C B D B G Y I F E N B V H
 A A C G B E J F Z B B K Q R I B N T A C R C Y J V K K T K P
 M Z F R I S T A B D B P O L J K O O V E P J R E I O V L R U
 F S K Q A G E Y P R C Z A W S K B M B M L N T F F O E A W Y
 H D B I M D J Y J C B Y W J U A U B O P J P E S R P F B Y N
 K J Y P B E Z O H G M Y V U E T E D U O P H I A N F G H B M
 N S N H E R U T P I R C S O A W L S V E Q E U C Y D S P G H
 C Q T Z T P Z F G R D O M E V L P T I A B D S G S H L U P B
 U I M O Y Z K V E G L J F P D B M B Z R Q B S Q M I C V F Y
 Q K H I N C C B U N S F S T Q P C B A Y F Y F F Z D D L Q A
 D T L V L E T S W G V A W C E P C B U D E V E I L E B R K O
 C D D V I C I V D Z R H U S N M V E E U G K J H U F Y R G M
 N Y R B O Q O M W J C A D C R A A I D H A K S W I W D E B B
 W H E Q V I T A Y P M H S H Y B Z R F A M J G U K Y T V Q H
 T U F E I H C R E K D N A H Y V O K Y E M M R I N S L U L N
 I Q U Y F W A Z P N L Z J U D L K B P M A V A K M K V V J B
 W S W E Q O N S Z U B Y H E J Q F P T C A W S E C T P P V V
 P S J L Z Z L H W O X N Q C I D K P O N O G F Y D E T I U I
 P I N N U K R D B F A J O N P V S U N A K Z D B N F J R B U
 W L S V A K P M E L C T E Q T S M Z I I C F N A Y Y I F E S
 Q S Z Q N Q I B M D W P W L V M O V J Z N I T T L R P V A S
 T J K T M J Q S W L J L E K R C A F J A Y Z Q I J E K Q F A
 A S I M O N P E T E R J B D F Z T R R S U T C O D N N B I L
 U F B A G B D V U M B C K D E L M K Y N D M D W V L D E M Y
 U F Z Q F B J O F S K V S O J U Z K T L Y G Y A C M A I I J
 H O F F H R Q J I Z O T B K O T J Y H A G G R E U A Y P O H
 E P H H A B R J B F I W H Q U M S R G I T R Q P A B S O Q W
 R E N P W K I E G P T H P K G O M G F D I H T Q U T G R H Z

BELIEVED
 DISCIPLE
 FOLDED
 HANDKERCHIEF
 JESUS

LAID
 LINEN
 LORD
 MARY MAGDALENE
 RAN

RISE
 SCRIPTURE
 SIMON PETER
 STONE
 TOMB



239. PETER AND JOHN VISIT JESUS' TOMB

(JOHN 20:1-10)

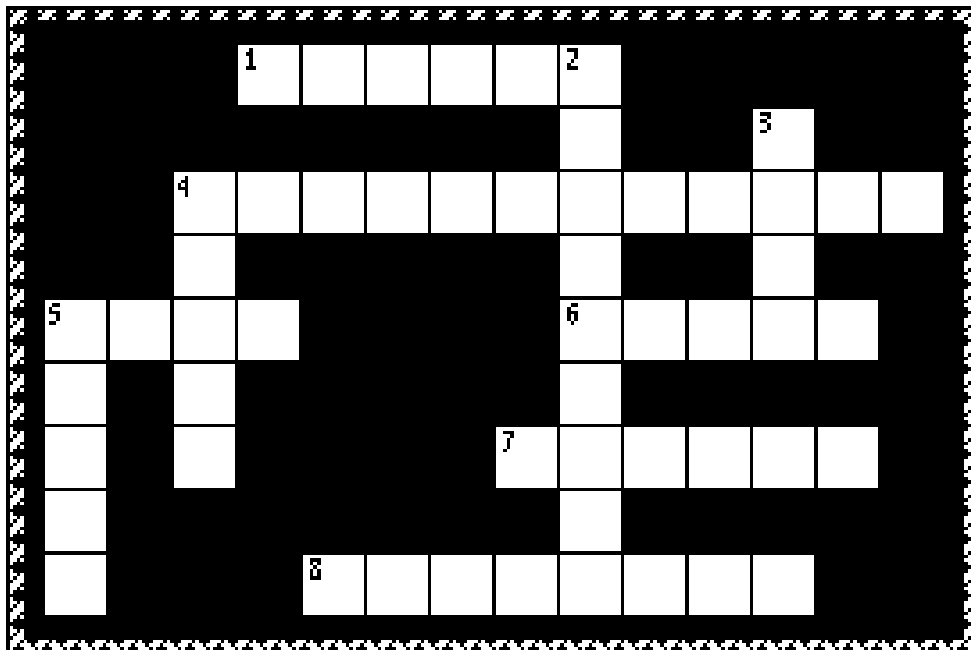

- 3 DOWN "For He taught His disciples and said to them, 'The Son of Man is being delivered into the hands of men, and they will kill Him. And after He is killed, He will _____ the third day.'" **MARK 9:31**
- 5 ACROSS "On the first day of the week Mary Magdalene came to the _____ early, while it was still dark, and saw that the stone had been taken away from the tomb." **JOHN 20:1**
- 5 DOWN "Then she ran and came to Simon Peter, and to the other disciple, whom Jesus loved, and said to them, 'They have _____ away the Lord out of the tomb, and we do not know where they have laid Him.'" **JOHN 20:2**
- 6 ACROSS "_____ therefore went out, and the other disciple, and were going to the tomb." **JOHN 20:3**
- 7 ACROSS "So they both ran together, and the other disciple _____ Peter and came to the tomb first." **JOHN 20:4**
- 1 ACROSS "And he, stooping down and looking in, saw the linen _____ lying there; yet he did not go in." **JOHN 20:5**
- 4 ACROSS "Then Simon Peter came, following him, and went into the tomb; and he saw the linen cloths lying there, and the _____ that had been around His head, not lying with the linen cloths, but folded together in a place by itself." **JOHN 20:6-7**
- 8 ACROSS "Then the other disciple, who came to the tomb first, went in also; and he saw and _____." **JOHN 20:8**
- 2 DOWN "For as yet they did not know the _____, that He must rise again from the dead." **JOHN 20:9**
- 4 DOWN "Then the disciples went away again to their own _____." **JOHN 20:10**

Bible Story 240

THE ROAD TO EMMMAUS

LUKE 24:13-35

240. THE ROAD TO EMMAUS (LUKE 24:13-35)



"And, behold, two of them went that same day to a village called Emmaus, which was from Jerusalem *about* threescore furlongs." **LUKE 24:13**

"And it came to pass, that, while they *communed together* and reasoned, Jesus himself drew near, and went with them." **LUKE 24:15**

240. THE ROAD TO EMMAUS

(LUKE 24:13-35)

MEMORY VERSE:

"And beginning at Moses and all the Prophets, He expounded to them in all the Scriptures the things concerning Himself." LUKE 24:27

TRUE OR FALSE:

1. "Now behold, two of them were traveling that same day to a village called Emmaus, which was about seven miles from Jerusalem." **LUKE 24:13**
TRUE OR FALSE
2. So it was, while they conversed and reasoned, that Jesus Himself drew near and went with them. But their eyes were not restrained, so that they knew Him. **LUKE 24:15-16**
TRUE OR FALSE

CIRCLE THE CORRECT WORDS:

3. "And He said to them, 'What kind of conversation is this that you have with one another as you walk and are (HAPPY, SAD)?' " **LUKE 24:17**
4. "Then the one whose name was (CLEOPAS, CLEOPATRA) answered and said to Him, 'Are You the only stranger in Jerusalem, and have You not known the things which happened there in these days?' " **LUKE 24:18**
5. "And He said to them, 'What things?' And they said to Him, 'The things concerning (NATHAN, JESUS) of Nazareth, who was a Prophet mighty in deed and word before God and all the people...' " **LUKE 24:19**
6. "Then He said to them, 'O foolish ones, and slow of (HEART, HEAD) to believe in all that the prophets have spoken!' " **LUKE 24:25**

TRUE OR FALSE:

7. "Ought not the Christ to have suffered these things and to enter into His glory?" **LUKE 24:26**
TRUE OR FALSE
8. "And beginning at Moses and all the Prophets, He expounded to them in all the Scriptures the things concerning Himself." **LUKE 24:27**
TRUE OR FALSE
9. "Then they drew near to the village where they were going, and He indicated that He would have gone farther. But they constrained Him, saying, 'Abide with us, for it is toward evening, and the day is far spent.' And He went in to stay with them." **LUKE 24:28-29**
TRUE OR FALSE

FILL IN THE BLANK:

10. "Now it came to pass, as He sat at the table with them, that He took _____, blessed and broke it, and gave it to them." **LUKE 24:30**

TRUE OR FALSE:

11. "Then their eyes were opened and they knew Him; and He vanished from their sight." **LUKE 24:31**
TRUE OR FALSE

240. THE ROAD TO EMMAUS

(LUKE 24:13-35)

T D V M E E D E R P E Z I A T
R B M O S E S M Z C I V K B S
A K Q T W O V I S I O N B D A
V K D T O C K O J D B F A E P
E A M E L A S U R E J R V R O
L T V M B C F A S T M K B E E
I W B T A L K E D B B M O F L
N L M O U V K T M B P K A F C
G N O I T A S R E V N O C U O
O A C E L R E G N A R T S S S
U P Y A D D R I H T P Y U E N
G P Z M P Z S M B G S U S E J
S C R I P T U R E S B G V F I
F A L B M T S I R H C R O P J
K B B N T E H P O R P G Z D J

CHRIST
CLEOPAS
CONVERSATION
EMMAUS
GOD
JERUSALEM

JESUS
MOSES
PROPHET
REDEEM
SCRIPTURES
STRANGER

SUFFERED
TALKED
THIRD DAY
TRAVELING
TWO
VISION

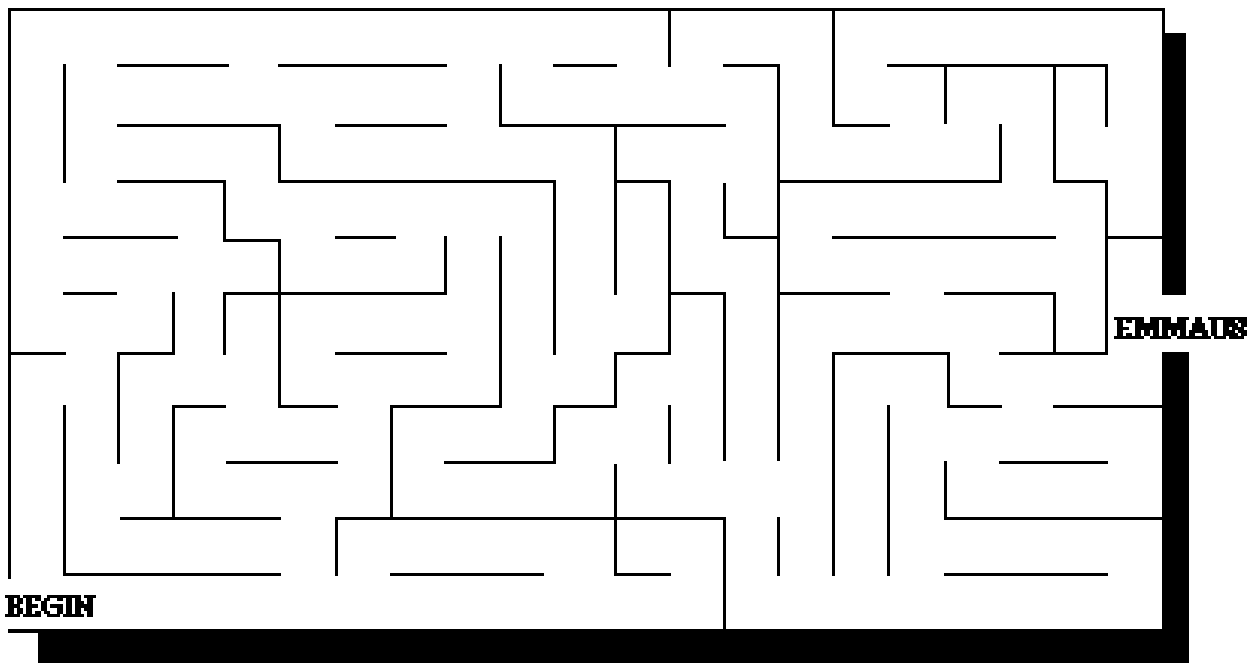

240. THE ROAD TO EMMAUS

(LUKE 24:13-35)

MEMORY VERSE:

"And beginning at Moses and all the Prophets, He expounded to them in all the Scriptures the things concerning Himself." LUKE 24:27

TRUE OR FALSE:

1. "Now behold, two of them were traveling that same day to a village called Emmaus, which was about seven miles from Jerusalem." LUKE 24:13
TRUE OR FALSE
2. So it was, while they conversed and reasoned, that Jesus Himself drew near and went with them. But their eyes were not restrained, so that they knew Him. LUKE 24:15-16
TRUE OR FALSE

FILL IN THE BLANKS:

3. "And He said to them, 'What kind of conversation is this that you have with one another as you walk and are _____?' " LUKE 24:17
4. "Then the one whose name was _____ answered and said to Him, 'Are You the only stranger in Jerusalem, and have You not known the things which happened there in these days?' " LUKE 24:18
5. "And He said to them, 'What things?' And they said to Him, 'The things concerning _____ of Nazareth, who was a Prophet mighty in deed and word before God and all the people...'" LUKE 24:19
6. "Then He said to them, 'O foolish ones, and _____ to believe in all that the prophets have spoken!' " LUKE 24:25

TRUE OR FALSE:

7. "Ought not the Christ to have suffered these things and to enter into His glory?" LUKE 24:26
TRUE OR FALSE
8. "And beginning at Moses and all the Prophets, He expounded to them in all the Scriptures the things concerning Himself." LUKE 24:27
TRUE OR FALSE
9. "Then they drew near to the village where they were going, and He indicated that He would have gone farther. But they constrained Him, saying, 'Abide with us, for it is toward evening, and the day is far spent.' And He went in to stay with them." LUKE 24:28-29
TRUE OR FALSE

FILL IN THE BLANKS:

10. "Now it came to pass, as He sat at the table with them, that He took _____, blessed and broke it, and gave it to them." LUKE 24:30
11. "Then their eyes were _____ and they knew Him; and He vanished from their sight." LUKE 24:31
12. "And they said to one another, 'Did not our heart _____ within us while He talked with us on the road, and while He opened the Scriptures to us?' " LUKE 24:32

240. THE ROAD TO EMMAUS

(LUKE 24:13-35)

S N Q G B I Z W G C K H S D V C A Y J C I H Q E U A Y B I J
 J S S A P O E L C B K P B D R Z T R J Z P U T P A B S I O H
 F Z T F R Q S D R M P J H O F L M G Y B G V B Q U T G P Q W
 F K A H B D H W G D Z H P K E U Z E T R C Y K T T O M O H Z
 O B Q A K J M Y N L Y Q E Q J T J M H D J Y I F E N B R U A
 P Z F W E Q B P G S Y O V K O M S M G P E R J V K K T A N P
 E F H B F R S Z Z V O A A L U O M A F J N R E I O V L V H B
 O H P P J I V W J R J W R W G E B U Y P H T E F O E A K P I
 O P J E G N I L E V A R T B F M P S Q Q E E F F P F B R U C
 C N R S T L O B P C B V L I B B C B D B D T W O F G H W Y N
 F G T O R S J M N M A M W J D N D B C Q B U S R F U P Y N Z
 K B B G P E J W U L H F J S B O T U M F Y S A N D S S B M F
 B G I D E H D U O M A S B B K B B A P Y A D D R I H T G H N
 T R A E J T E E F B O W O E K C B V O G B S G Y H L B P B F
 A Q M P Z F E T E B H S E A A U O B E A B F Q M D C V F Y P
 L I B Z Z A A F L M Z B E V T L G N A M J J F Z F Y L Q A G
 K P S E R U T P I R C S P S W P E O V M M S H U W D R K O G
 E H T C S Y W I L A Y D T D L M I U Y E V G W I Y T R G M Z
 D Z Y C K T L B M C N S C Q A C K V U A R R U K S L E B B A
 Y I L Q C Y R G S W J J S E P C B Z H O W S I N G V V Q H B
 N V I I T O Z A Z J T H C N P V P A A K Z A A M K O U L N K
 M V O W I F B Y N U N Q H R A Z P U E C F S K T T P D J B O
 H B V Z O V P P F G P O U Y B K U E C Y T F E C I T V V V M
 L Q Q K T B J Y P K E O I Y V F Z F N S I N Y D E O P U I Y
 D J E R U S A L E M L R E S Q K V P I U Z T B N F J N B U S
 R Y Z K A S H B G O J E C D I S F R A D T Q T Y Y I I E S G
 E E U Q N V G D K B C W N J D V H T I Y M C I J R P R A S U
 U L A J R M E R B T V E Q I V C R O Z G G D O D N B F F A I
 W N N S U S E J U E T B L P S M K N S T G Y W V L D V I L S
 J V M B P A B C B J W K K T M O K I N I R R A C M A Q M Y C

CHRIST

JESUS

SUFFERED

CLEOPAS

MOSES

TALKED

CONVERSATION

PROPHET

THIRD DAY

EMMAUS

REDEEM

TRAVELING

GOD

SCRIPTURES

TWO

JERUSALEM

STRANGER

VISION

240. THE ROAD TO EMMAUS

(LUKE 24:13-35)

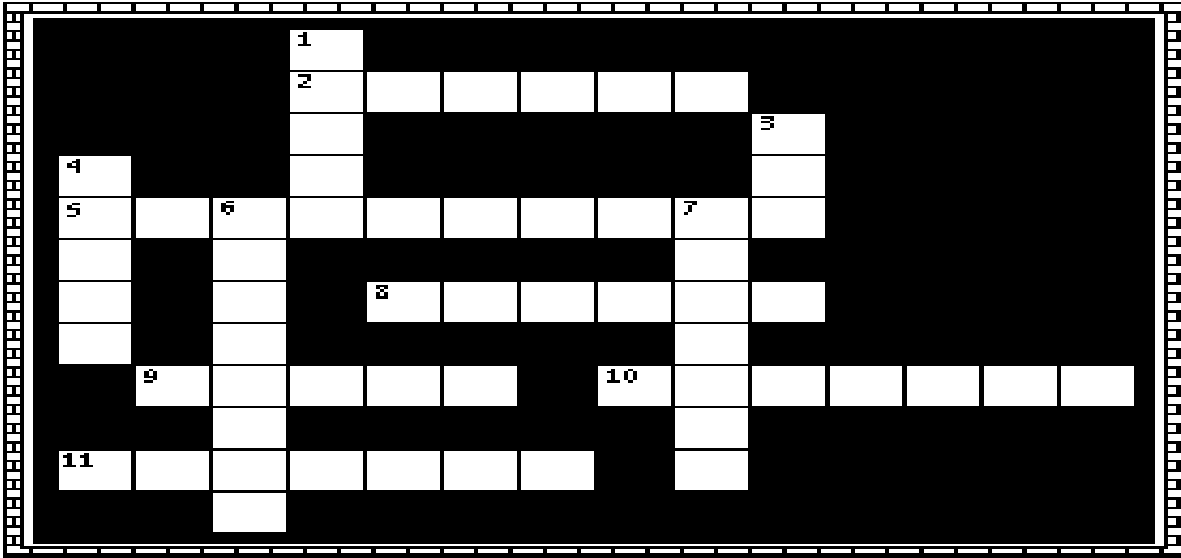

- 2 ACROSS "Now behold, two of them were traveling that same day to a village called _____, which was about seven miles from Jerusalem." **LUKE 24:13**
- 5 ACROSS "So it was, while they conversed and reasoned, that Jesus Himself drew near and went with them. But their eyes were _____, so that they did not know Him." **LUKE 24:15-16**
- 3 DOWN "And He said to them, 'What kind of conversation is this that you have with one another as you walk and are _____?' " **LUKE 24:17**
- 11 ACROSS "Then the one whose name was _____ answered and said to Him, 'Are You the only stranger in Jerusalem, and have You not known the things which happened there in these _____ days?' " **LUKE 24:18**
- 9 ACROSS "And they said to Him, 'The things concerning _____ of Nazareth, who was a Prophet mighty in deed and word before God and all the people...'" **LUKE 24:19**
- 1 DOWN "Then He said to them, 'O foolish ones, and slow of _____ to believe in all that the prophets have spoken!' " **LUKE 24:25**
- 6 DOWN "Ought not the Christ to have _____ these things and to enter into His glory?" **LUKE 24:26**
- 10 ACROSS "And beginning at Moses and all the Prophets, He expounded to them in all the Scriptures the things concerning _____." **LUKE 24:27**
- 7 DOWN "But they constrained Him, saying, 'Abide with us, for it is toward _____, and the day is far spent.' And He went in to stay with them." **LUKE 24:28-29**
- 4 DOWN "Now it came to pass, as He sat at the table with them, that He took _____, blessed and broke it, and gave it to them." **LUKE 24:30**
- 8 ACROSS "Then their eyes were _____ and they knew Him; and He vanished from their sight." **LUKE 24:31**

Bible Story 241

THOMAS DOUBTS

JOHN 20: 24-29

241. THOMAS DOUBTS

(JOHN 20:24-29)



"The other disciples therefore said unto him, We have seen the Lord. But he said unto them, Except I shall see in his hands the print of the nails, and put my finger into the print of the nails, and thrust my hand into his side, I will not believe."

JOHN 20:25

241. THOMAS DOUBTS

(JOHN 20:24-29)

MEMORY VERSE:

"Jesus said to him, 'Thomas, because you have seen Me, you have believed. Blessed are those who have not seen and yet have believed.' " JOHN 20:29

TRUE OR FALSE:

1. "But Thomas, called Didymus, one of the twelve, was not with them when Jesus came." JOHN 20:24

TRUE OR FALSE

2. The other disciples therefore said to him, "We have not seen the Lord."...JOHN 20:25

TRUE OR FALSE

3. "...But he said to them, 'Unless I see in His hands the print of the nails, and put my finger into the print of the nails, and put my hand into His side, I will not believe.' " JOHN 20:25

TRUE OR FALSE

CIRCLE THE CORRECT WORDS:

4. "And after (**EIGHT, EIGHTEEN**)days His disciples were again inside, and Thomas was with them. Jesus came, the doors being shut, and stood in the midst, and said, 'Peace to you!' " JOHN 20:26

5. "Then He said to Thomas, 'Reach your finger here, and look at My hands; and reach your hand here, and put it into My side. Do not be unbelieving, but (**BELIEVE, DOUBTING**)." JOHN 20:27

TRUE OR FALSE:

6. "And Thomas answered and said to Him, 'My Lord and my God!' " JOHN 20:28

TRUE OR FALSE

FILL IN THE BLANK:

7. "Jesus said to him, 'Thomas, because you have seen Me, you have believed. _____ are those who have not seen and yet have believed.' " JOHN 20:29

241. THOMAS DOUBTS

(JOHN 20:24-29)

W S A M O H T M Z D U C G L U
Z B Z N Q A B B B T F N E E S
B B B D R O L S S R W G N M M
K H A N D S S V T I E E G S D
Q E E V E I L E B S D G L Z L
J F C R R Y V O P W D E N V S
J J T P I Y M J J Y I I Z I E
E T I I L O A J H P B R M F F
S S E L P I C S I D G D J P V
U D O G E C A E P Z Y E P G R
S E O Q S S Z E G W P S N K C
B J T D T F L A E B Y S B B M
D I D Y M U S I U M B E O B L
B Z A J F V S W A W D L B K B
R T N I R P H L W N R B L C B

BELIEVE
BLESSED
DIDYMUS
DISCIPLES
FINGER
GOD

HANDS
JESUS
LORD
MIDST
NAILS
PEACE

PRINT
SEEN
SIDE
THOMAS
TWELVE

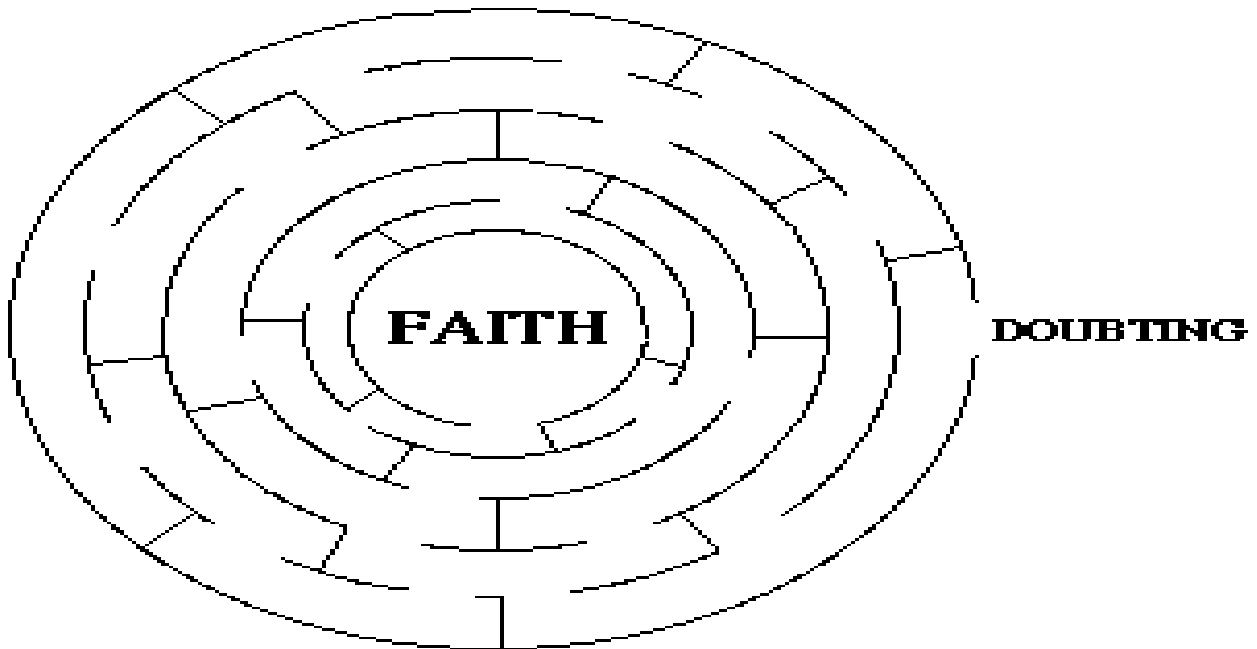

241. THOMAS DOUBTS

(JOHN 20:24-29)

MEMORY VERSE:

"Jesus said to him, 'Thomas, because you have seen Me, you have believed. Blessed are those who have not seen and yet have believed.' " JOHN 20:29

TRUE OR FALSE:

1. "But Thomas, called Didymus, one of the twelve, was not with them when Jesus came." JOHN 20:24

TRUE OR FALSE

2. The other disciples therefore said to him, "We have not seen the Lord."...JOHN 20:25

TRUE OR FALSE

FILL IN THE BLANKS:

3. "...But he said to them, 'Unless I see in His _____ the print of the nails, and put my finger into the print of the nails, and put my hand into His _____, I will not believe.' " JOHN 20:25

4. "And after _____ days His disciples were again inside, and Thomas was with them. Jesus came, the doors being shut, and stood in the midst, and said, 'Peace to you!' " JOHN 20:26

5. "Then He said to Thomas, 'Reach your finger here, and look at My hands; and reach your hand here, and put it into My side. Do not be unbelieving, but _____.'" JOHN 20:27

TRUE OR FALSE:

6. "And Thomas answered and said to Him, 'My Lord and my God!' " JOHN 20:28

TRUE OR FALSE

FILL IN THE BLANK:

7. "Jesus said to him, 'Thomas, because you have seen Me, you have believed. _____ are those who have not seen and yet have believed.'" JOHN 20:29

241. THOMAS DOUBTS

(JOHN 20:24-29)

U S U J B A G J R B E G V A S C E P V P T N U Z Q W U T T R
 I T U F Z Q F B P S U N R H W S N P Z U O A D T C J E S U S
 W O H F F F H B S V W G C Z U C R A K Z N I Y M D A A O L W
 V T E O H H A R L M D Z M Y D H Y B F V I Z G G Y E U N A Y
 B W R P N P W B I A W J L N S U Y V K T J S T G R P T K B B
 M F J E G J B K A Z Y P B J J E D Q S F S N I R Q Q E V H G
 C A S O M T P E N S P N B T H C J D M R J D I S E E N E P P
 B M T O G B E F I H Z U A P Q N I V O K Y C I H T T K F U F
 H G A C D E S S E L B O C L O Q P S A K T Z P M B F O G V Q
 P F O F R I S J Q M W F W J E L T M T Y H B G U K V O S L K
 D H Z D Q A G T D B B L J C W K V C M R G R C V I I P L R G
 E K S K I M D E J S M L B V E D R Z Z G F P J Y J F F C R B
 B N D B P B E J Q V W M K T B D F L J D R O L Y E R D Y E Q
 C C J Y H T P Z R O U S R W K D E U S I Y J N R F N H D V L
 P U Q N Z Y Z Z I J F E O H S O I T M K Q P H T S Y D T U J
 O Q I M I L C K L J G Z I P B K J S M U D Q E E A M F L V V
 G D S U M Y D I D N I F T J H Q O M C A C B D U G Z W V P U
 U C B H S I C C I E B P E H P K U O P I M Q B S Q U Y P I B
 P N T L V I Q F S A G G J Q E L G E C V P F Y S F I S T R E
 M W D D V O D T T H Y K K O V W F M D B P L B F H B B J F A
 N T Y R B V I E A W P B B A A B B B T O O G E J W N T I V F
 R I H E Q Q W N F L Y U P W R I D N B U E A K S U M E P Q I
 B W U U Y Z D I A Z B K Z V L J B O B V A M J S I C F B B M
 D P Q W E S Z O Y B D C Y M W S B B E C A E P G K D Y D I I
 C B E L I E V E Y P T T Y P J U B U G Z Y M M R E N R A P O
 U P S J L U K T O W H U O R U E A L E A U A V A Y Y N Y O Q
 G W S N N A K A E O R M J I O A T P I U H O W S B J L S R H
 D Q I S V N Q L M J C D F N E V W M K E A K Z F T D M G A U
 T T L Z Q M V A F H G L A T P D L C B F E C F N I V A M V N
 A A S K T E S N V G R S H F T Q A C P P C Y I T O C B B B H

BELIEVE
 BLESSED
 DIDYMUS
 DISCIPLES
 FINGER
 GOD

HANDS
 JESUS
 LORD
 MIDST
 NAILS
 PEACE

PRINT
 SEEN
 SIDE
 THOMAS
 TWELVE



241. THOMAS DOUBTS

(JOHN 20:24-29)

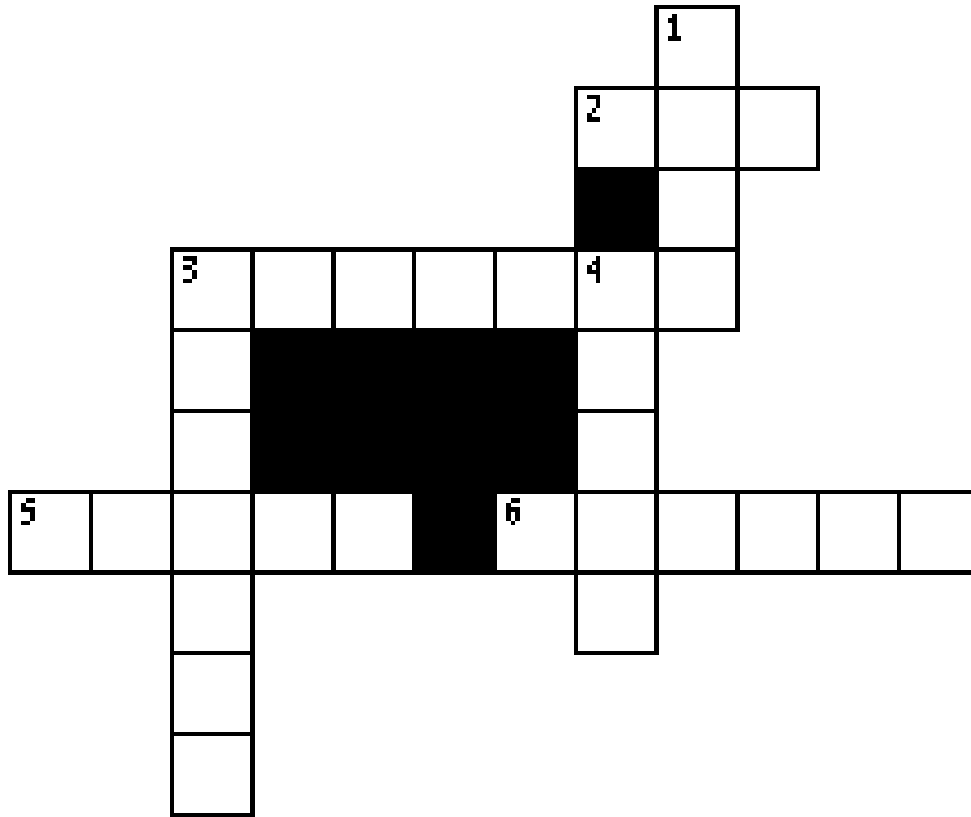

- 6 ACROSS "But _____, called Didymus, one of the twelve, was not with them when Jesus came." **JOHN 20:24**
- 1 DOWN "The other disciples therefore said to him, 'We have seen the _____.'" **JOHN 20:25**
- 5 ACROSS "...But he said to them, 'Unless I see in His hands the _____ of the nails, and put my finger into the print of the nails, and put my hand into His side, I will not believe.'" **JOHN 20:25**
- 4 DOWN "And after _____ days His disciples were again inside, and Thomas was with them. Jesus came, the doors being shut, and stood in the midst, and said, 'Peace to you!'" **JOHN 20:26**
- 3 DOWN "Then He said to Thomas, 'Reach your finger here, and look at My hands; and reach your hand here, and put it into My side. Do not be unbelieving, but _____.'" **JOHN 20:27**
- 2 ACROSS "And Thomas answered and said to Him, 'My Lord and my _____!'" **JOHN 20:28**
- 3 ACROSS "Jesus said to him, 'Thomas, because you have seen Me, you have believed. _____ are those who have not seen and yet have believed.'" **JOHN 20:29**

Bible Story 242

JESUS HELPS CATCH FISH

JOHN 21:1-14

242. JESUS HELPS CATCH FISH

(JOHN 21:1-14)



"And he said unto them, Cast the net on the right side of the ship, and ye shall find. They cast therefore, and now they were not able to draw it for the multitude of fishes."

JOHN 21:6

242. JESUS HELPS CATCH FISH

(JOHN 21:1-14)

MEMORY VERSE:

"And truly Jesus did many other signs in the presence of His disciples, which are not written in this book; but these are written that you may believe that Jesus is the Christ, the Son of God, and that believing you may have life in His name." JOHN 20:30-31

CIRCLE THE CORRECT WORD:

1. "Simon Peter said to them, 'I am going (**SAILING, FISHING**).' They said to him, 'We are going with you also.' They went out and immediately got into the boat, and that night they caught nothing." **JOHN 21:3**

TRUE OR FALSE:

2. "But when the morning had now come, Jesus stood on the shore; yet the disciples did not know that it was Jesus." **JOHN 21:4**

TRUE OR FALSE

3. "Then Jesus said to them, 'Children, have you any food?' They answered Him, 'No.' " **JOHN 21:5**

TRUE OR FALSE

CIRCLE THE CORRECT WORD:

4. "And He said to them, 'Cast the net on the right side of the boat, and you will find some.' So they cast, and now they were not able to draw it in because of the multitude of (**SEAWEED, FISH**)." **JOHN 21:6**

TRUE OR FALSE:

5. "Then, as soon as they had come to land, they saw a fire of coals there, and fish laid on it, and bread." **JOHN 21:9**

TRUE OR FALSE

CIRCLE THE CORRECT ANSWER:

6. "Simon Peter went up and dragged the net to land, full of large fish, one hundred and fifty-three; and although there were so many, the net (**WAS, WAS NOT**) broken." **JOHN 21:11**

TRUE OR FALSE:

7. "Jesus then came and took the bread and gave it to them, and likewise the fish." **JOHN 21:13**

TRUE OR FALSE

8. This is now the tenth time Jesus showed Himself to His disciples after He was raised from the dead. **JOHN 21:14**

TRUE OR FALSE

242. JESUS HELPS CATCH FISH

(JOHN 21:1-14)

B U I P S F V Y Z C J T N B C
R M S S H E I M U Z U Z Q D B
E U A L O Z C R J E S U S P R
A Y I E R R E T E P N O M I S
K J R A E B C I M O R N I N G
F E E N H D Q Y T H G I N E A
A S B A R R G N I H S I F W G
S U I H V O V R A I S E D B A
T S T T B L J M F I S H M D R
R M F A B B O A T Q Q O A I C
T S O N S O F Z E B E D E E F
J P A Y O P Q A N L Y B M C O
M M E D I S C I P L E S B H R
B H S V J B T S A C C V G T Y
A M D A E R B N O T H I N G R

BOAT
BREAD
BREAKFAST
CAST
DISCIPLES
FIRE
FISH

FISHING
JESUS
NIGHT
LORD
MORNING
NATHANAEL

NOTHING
RAISED
SEA OF TIBERIAS
SHORE
SIMON PETER
SONS OF ZEBEDEE

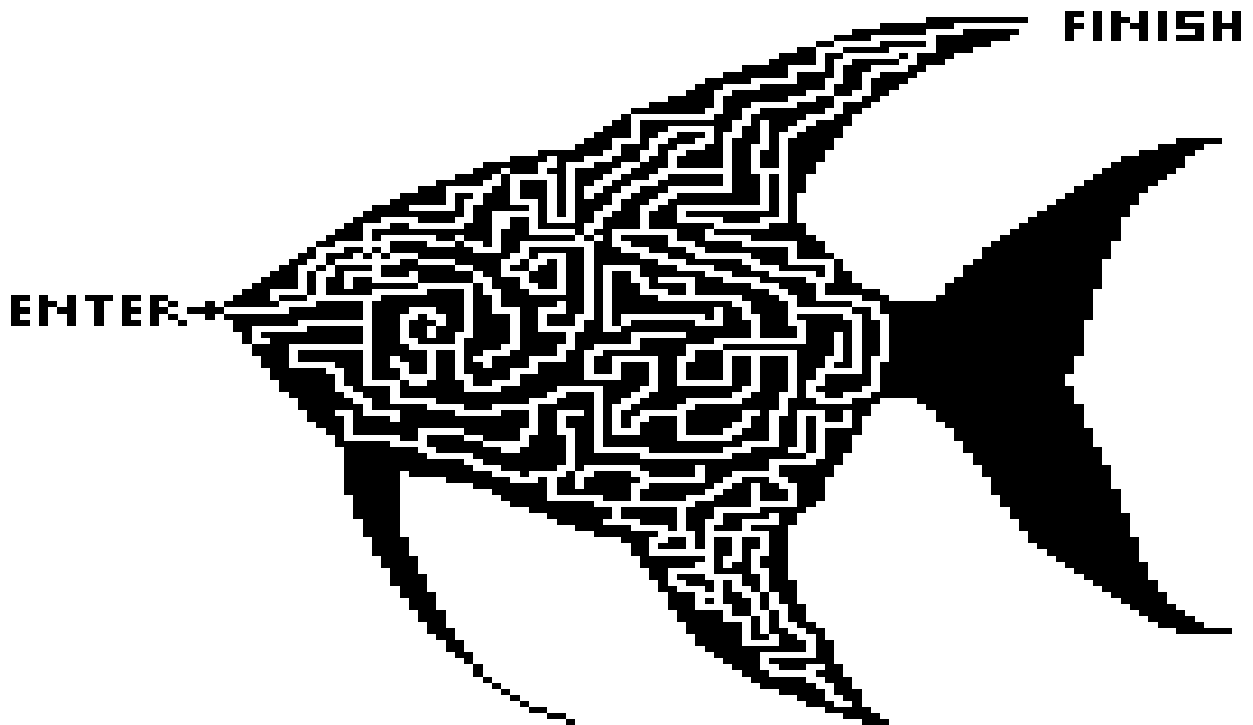

242. JESUS HELPS CATCH FISH

(JOHN 21:1-14)

MEMORY VERSE:

"And truly Jesus did many other signs in the presence of His disciples, which are not written in this book; but these are written that you may believe that Jesus is the Christ, the Son of God, and that believing you may have life in His name." JOHN 20:30-31

FILL IN THE BLANK:

1. "Simon Peter said to them, 'I am going _____.' They said to him, 'We are going with you also.' They went out and immediately got into the boat, and that night they caught nothing." **JOHN 21:3**

TRUE OR FALSE:

2. "But when the morning had now come, Jesus stood on the shore; yet the disciples did not know that it was Jesus." **JOHN 21:4**

TRUE OR FALSE

3. "Then Jesus said to them, 'Children, have you any food?' They answered Him, 'No.' " **JOHN 21:5**

TRUE OR FALSE

FILL IN THE BLANK:

4. "And He said to them, 'Cast the net on the right side of the boat, and you will find some.' So they cast, and now they were not able to draw it in because of the _____ of fish." **JOHN 21:6**

TRUE OR FALSE:

5. "Then, as soon as they had come to land, they saw a fire of coals there, and fish laid on it, and bread." **JOHN 21:9**

TRUE OR FALSE

FILL IN THE BLANKS:

6. "Simon Peter went up and dragged the net to land, full of large fish, one hundred and fifty-three; and although there were so many, the net was not _____." **JOHN 21:11**

7. "Jesus then came and took the _____ and gave it to them, and likewise the _____." **JOHN 21:13**

TRUE OR FALSE:

8. This is now the tenth time Jesus showed Himself to His disciples after He was raised from the dead. **JOHN 21:14**

TRUE OR FALSE

242. JESUS HELPS CATCH FISH (JOHN 21:1-14)

B Q B P Z F J W O L A F J K F E B O D Q Y F A M D C V G U I
 Y I G N I H S I F B H S B I K M D U B F K J G Z F Y L P Y C
 N P T Z K A E U F B Z W O J D B T V M G K S Q U W D R F N N
 M H Y C C Y A F L A Y U E S B N B R P A J G F I Y T R Q M Z
 H Z L C T Y W I L C N D P U K O B A O T M R H K S L E K H F
 L I I Q I O L M M W J S T E K B G I E M S A W N K V V G B N
 D V L O R D Z G S J T J C A A U E S A M V A U M T P U M Y F
 R V O I O F B Y Z U P H S V T L I E Y A W S F C E T V Q A P
 E M V W L E A N A H T A N D W P K D U O Z F I K F J P L O G
 U B O Z T V P P F K L Q C Q L M B Z H K F N K D A I I J M G
 W Q Q R J B J Y P O J O H E A C P A A C I B E G Y E R V B Z
 J Y Z K N E H B G I C E U N P C P U E Y Z O Y N N P R U H A
 N E U K A I S D K F V W E R P V U E B U T A B Y R I F B N B
 N L A Q N S N U B T I E C Y A S Z F N D M T T J N K H B B B
 I N N J R V G G S E T R N Y B Z O P A Y G T I D L D V T V O
 G V M B P M E R U J W B E D V K V N I G G Q O V M A Q E O M
 H Q S A I R E B I T F O A E S F F T S T R C W C A Y B A I N
 T T G B D A U C K K H K Q J Q K R O Z O H D A U B S I F U Y
 S A F R I I W G C K P S L I D S K N S I F Y E A T G P I S S
 Z Q H B Q Z S R U P J U K P V M K I N I U Z P U C M O M S G
 K F A K D S D C M Z H H D T S O Y J C P V R E T O A R I A U
 B H W E J H W G I Y E P D V M A R J Z G Y Q Q B N B S O L I
 Z P B F Q M Y N D P Q R O R C T G Y B C D T T E E T A T Y S
 F J P J R B P G L Y L E O F Z M I T R A Y B F K K D V Q J C
 H S I M O N P E T E R E K H L Z K H E J R K V O V L E H H T
 N T E T I S Z Z S O O V S E S J U R P N T I I O E A K E W E
 G B S E L V W J V J A A Q J U S B G J H E J F P F B R U Z K
 B I G J S O B P R F W R K O T M A F P E U E R F G H W N A E
 G A D H S I F N C A V L L U M B V Y Q D S F N D S P Y H P O
 R M E Z T J M U M H M W W G O P B Q B B S S Y H L U B P B E

BOAT
 BREAD
 BREAKFAST
 CAST
 DISCIPLES
 FIRE
 FISH

FISHING
 JESUS
 LORD
 MORNING
 NATHANAEL
 NIGHT

NOTHING
 RAISED
 SEA OF TIBERIAS
 SHORE
 SIMON PETER
 SONS OF ZEBEDEE

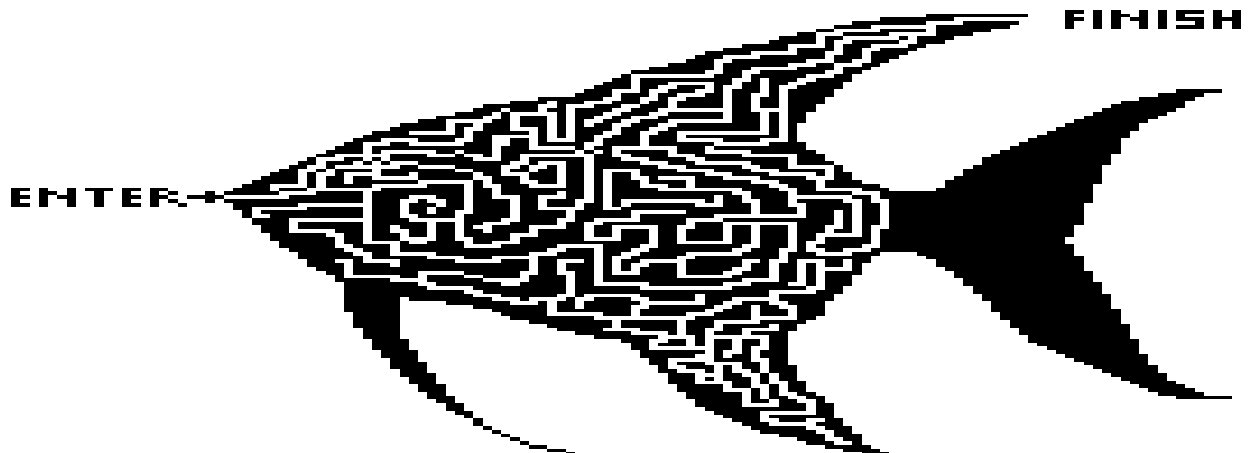

242. JESUS HELPS CATCH FISH

(JOHN 21:1-14)

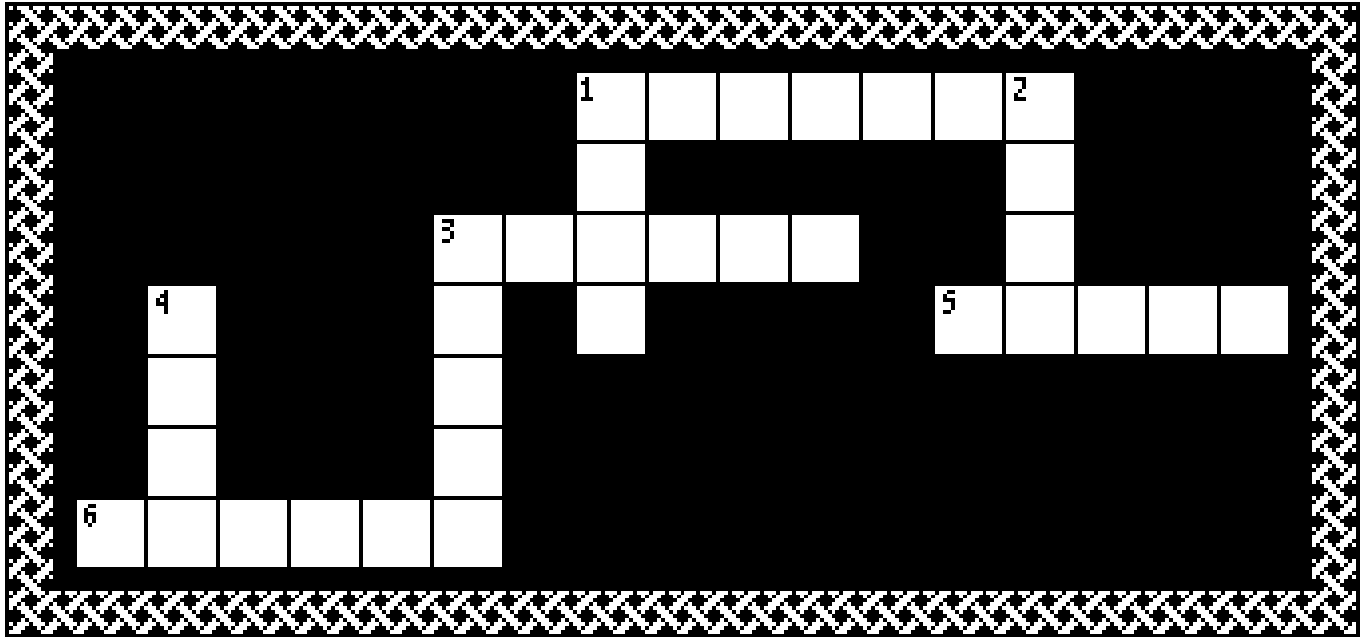

- 1 ACROSS "Simon Peter said to them, 'I am going ____.' They said to him, 'We are going with you also.' They went out and immediately got into the boat, and that night they caught nothing." **JOHN 21:3**
- 5 ACROSS "But when the morning had now come, Jesus stood on the shore; yet the disciples did not know that it was ____." **JOHN 21:4**
- 1 DOWN "Then Jesus said to them, 'Children, have you any ____?' They answered Him, 'No.'" **JOHN 21:5**
- 4 DOWN "And He said to them, 'Cast the net on the right side of the boat, and you will find some.' So they cast, and now they were not able to draw it in because of the multitude of ____." **JOHN 21:6**
- 3 DOWN "Then, as soon as they had come to land, they saw a fire of coals there, and fish laid on it, and ____." **JOHN 21:9**
- 3 ACROSS "Simon Peter went up and dragged the net to land, full of large fish, one hundred and fifty-three; and although there were so many, the net was not ____." **JOHN 21:11**
- 2 DOWN "Jesus then came and took the bread and ____ it to them, and likewise the fish." **JOHN 21:13**
- 6 ACROSS "This is now the third time Jesus ____ Himself to His disciples after He was raised from the dead." **JOHN 21:14**

Bible Story 243

**JESUS
RESTORES
PETER**

JOHN 21:15-19



"Jesus restores Peter"
John 21:15-19

243. JESUS RESTORES PETER

(JOHN 21:15-19)

MEMORY VERSE:

"The LORD is my shepherd; I shall not want. He makes me to lie down in green pastures; He leads me beside still waters. He restores my soul; He leads me in the paths of righteousness for His name's sake." PSALM 23:1-3

UNDERLINE THE CORRECT ANSWERS:

1. "So when they had eaten breakfast, Jesus said to Simon Peter, 'Simon, son of Jonah,...' " **JOHN 21:15**
 - a. Do you love Me more than these?
 - b. Do you need Me more than these?
2. "...He said to Him, 'Yes, Lord; You know that I love You.' He said to him,...' " **JOHN 21:15**
 - a. That is all I wanted to know
 - b. Feed My lambs

CIRCLE THE CORRECT WORD:

3. "He said to him again a second time, 'Simon, son of Jonah, do you love Me?' He said to Him, 'Yes, Lord; You know that I love You.' He said to him, '(**BEND, TEND**) My sheep.' " **JOHN 21:16**

TRUE OR FALSE:

4. "He said to him the third time, 'Simon, son of Jonah, do you love Me?' Peter was grieved because He said to him the third time, 'Do you love Me?'..." **JOHN 21:17**

TRUE OR FALSE

CIRCLE THE CORRECT WORDS:

5. "...And he said to Him, 'Lord, You know (**ALL, SOME**) things; You know that I love You.'..." **JOHN 21:17**
6. "...Jesus said to him, '(**NEED, FEED**) My sheep.' " **JOHN 21:17**

FILL IN THE BLANKS:

7. "Most assuredly, I say to you, when you were younger, you girded yourself and walked where you _____; but when you are old, you will stretch out your hands, and another will gird you and carry you where you do _____ wish." **JOHN 21:18**

TRUE OR FALSE:

8. "This He spoke, signifying by what death he would glorify God..." **JOHN 21:19**

TRUE OR FALSE

9. "...And when He had spoken this, He said to him, 'Follow Me.' " **JOHN 21:19**

TRUE OR FALSE

243. JESUS RESTORES PETER

(JOHN 21:15-19)

K	P	E	E	H	S	V	J	G	W	Y	G	O	B	B
N	Q	E	T	S	T	M	J	L	J	P	Z	F	B	H
O	J	J	A	B	F	A	E	O	W	E	J	L	B	S
W	B	Z	N	M	A	Z	A	V	B	O	S	L	M	I
Q	B	T	S	A	F	K	A	E	R	B	L	U	D	W
I	R	Z	R	L	Y	S	W	E	M	Y	P	L	S	A
F	B	K	P	Q	Y	H	L	U	W	B	N	M	O	C
E	K	C	I	R	O	M	Z	W	D	D	U	S	L	F
E	H	A	N	O	J	F	O	N	O	S	Y	Z	S	W
D	E	T	Q	I	F	B	E	D	B	R	F	F	V	J
W	F	D	R	I	G	T	B	W	F	C	I	P	R	U
Z	J	I	D	L	V	S	P	Y	I	G	R	G	C	E
S	I	M	O	N	P	E	T	E	R	R	O	K	M	R
K	T	O	J	S	B	V	J	P	B	G	L	B	L	O
K	D	R	O	L	S	O	H	Z	G	N	G	U	B	M

BREAKFAST
FEED
FOLLOW
GIRD
GLORIFY
JESUS

KNOW
LAMBS
LORD
LOVE
MORE

SHEEP
SIMON PETER
SON OF JONAH
TEND
WISH

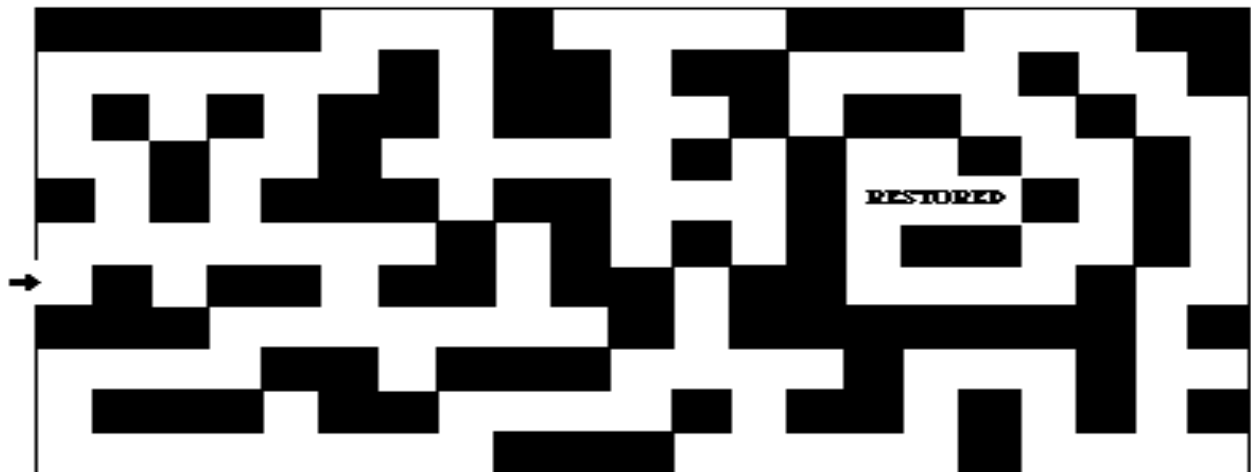

243. JESUS RESTORES PETER

(JOHN 21:15-19)

MEMORY VERSE:

"The LORD is my shepherd; I shall not want. He makes me to lie down in green pastures; He leads me beside still waters. He restores my soul; He leads me in the paths of righteousness for His name's sake." PSALM 23:1-3

UNDERLINE THE CORRECT ANSWERS:

- "So when they had eaten breakfast, Jesus said to Simon Peter, 'Simon, son of Jonah,...' " **JOHN 21:15**
 - Do you love Me more than these?
 - Do you need Me more than these?
- "...He said to Him, 'Yes, Lord; You know that I love You.' He said to him,...' " **JOHN 21:15**
 - That is all I wanted to know
 - Feed My lambs

FILL IN THE BLANK:

- "He said to him again a second time, 'Simon, son of Jonah, do you love Me?' He said to Him, 'Yes, Lord; You know that I love You.' He said to him, '_____ My sheep.' " **JOHN 21:16**

TRUE OR FALSE:

- "He said to him the third time, 'Simon, son of Jonah, do you love Me?' Peter was grieved because He said to him the third time, 'Do you love Me?'..." **JOHN 21:17**

TRUE OR FALSE

FILL IN THE BLANKS:

- "...And he said to Him, 'Lord, You know _____ things; You know that I love You.'..." **JOHN 21:17**
- "...Jesus said to him, '_____ My sheep.' " **JOHN 21:17**
- "Most assuredly, I say to you, when you were younger, you girded yourself and walked where you _____; but when you are old, you will stretch out your hands, and another will gird you and carry you where you do _____ wish." **JOHN 21:18**

TRUE OR FALSE:

- "This He spoke, signifying by what death he would glorify God..." **JOHN 21:19**

TRUE OR FALSE

- "...And when He had spoken this, He said to him, 'Follow Me.' " **JOHN 21:19**

TRUE OR FALSE

243. JESUS RESTORES PETER

(JOHN 21:15-19)

I N S W S M T Y Y Z W T U B B U W Z B U C Y M P F B B I U K
D G P E Q D Q Q F H Z L B G W Q B F A C M A N L H I M J K S
Y K M L V W H U O K O U S P I T M B M Q P Q Q J D V I L I U
E B B V P Q A Q J S A W E F O L L O W N M A R D R S U M B N
D Y B D B B S T W K B Q J S U P K B Z R L O U D S M B P R E
P K O D Q I U I S R K M M O M L N K B U C Y M R M K W B Q S
U P H Z J T U H M E U N A T F J O M T K S E E M C I V E I B
G U S Z I A T T S O N I G L O B W Z P B G A S J U R K C J T
I Y S O C L T T I N N D R I G J L B Z I E S U S E J G H L I
C F R W T B D R A C U P O W E H U I F F Y E Z L R K P M J L
E K V H C Z D R G V D S E I P T G Z V W B Q P P S Q H B V E
U T N Q J Z Q W W C L V V T K J C F F L R U J Y J Y K I R I
B G G I W N C P A C U U E H E Y V Z H J E T H F L C H V R A
M E D L Y K U N F H F U S R J R U B N B A V D I P Z C M K K
K Y P H J O J B U R L A P J O R B D E B K S C R B A O T J Q
U G K T T B K B T E Y D T D F M N K E K F E U O N K V Q S Y
Y M T Y N H S C S M H D W U Y D H B M J A T U L S R N V F R
Y Q S E A F M D O O W W B O T C B U J K S K S G L V J U Q B
R H P O N V J W M Q N T H L W G A Y Q U T N Y O P Z L G V T
F V P A S D T K J N O O J O U S U E V M U B J L H Y D B B P
H V R V L I A I K Y I L F H S I W E B D W Y G T L E R D R K
E G B C P O A E G M R A Y J G Q V J V E I Z A P Q H Z O B Z
L S O A U N U P H A F O B U O U A A V E A A K N U Z B N I O
M N S L T H E I G S Y A P I H N E V L F C B R R I C Y Z U V
G B L O N I N Y D V B P S I B M A K A B D U B A C S A F Q L
M K K Z D U Q B E Y D A H B V J I H I R L E N P C G E N H C
B K W M R A B V V B F D E R S Q S U O Y P D Y L M I M B C Y
P O V F A F O B B W B Y E W U L G L L R A K N Y R F B A C Y
M J J M Z L N P G L E S P G B J J O R T I G M M B L Z D N P
W Q X Q E F A P C W H M G T H T P Z U T E C Q T G B U P B D

BREAKFAST
FEED
FOLLOW
GIRD
GLORIFY
JESUS

KNOW
LAMBS
LORD
LOVE
MORE

SHEEP
SIMON PETER
SON OF JONAH
TEND
WISH

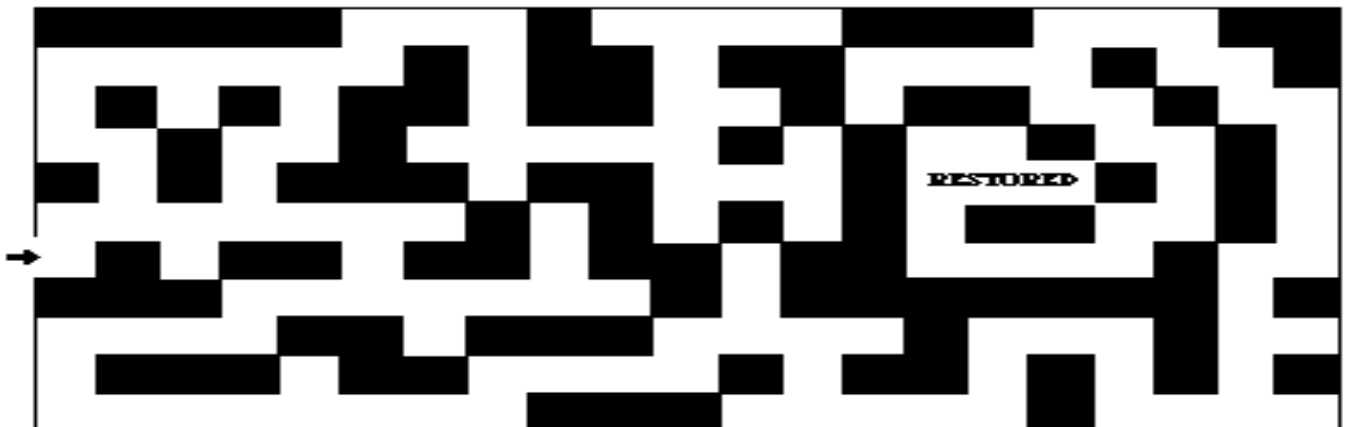

243. JESUS RESTORES PETER

(JOHN 21:15-19)

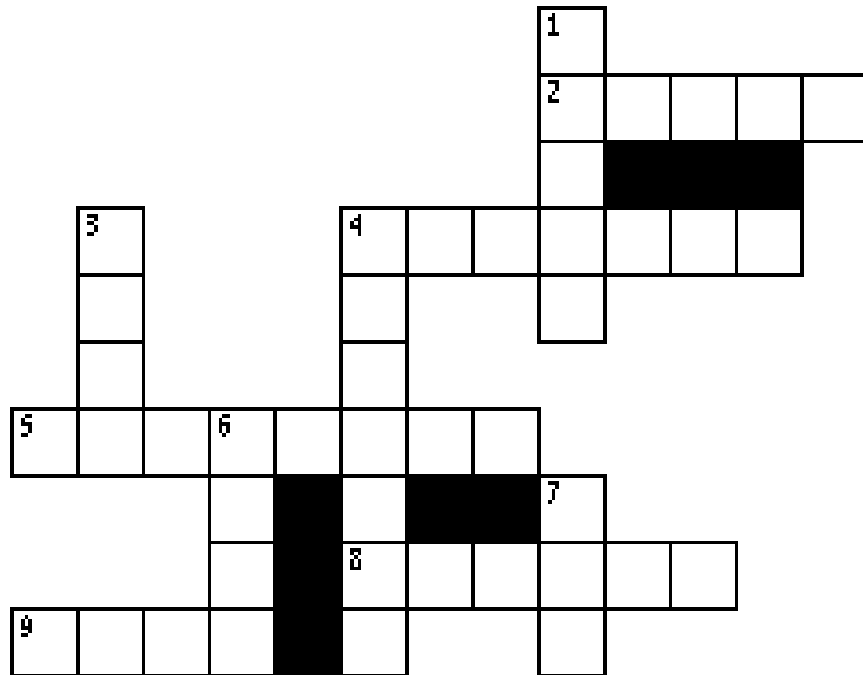

- 5 ACROSS "The LORD is my shepherd; I shall not want. He makes me to lie down in green pastures; He leads me beside still waters. He _____ my soul; He leads me in the paths of righteousness for His name's sake." **PSALM 23:1-3**
- 3 DOWN "So when they had eaten breakfast, Jesus said to Simon Peter, 'Simon, son of Jonah, 'Do you _____ Me more than these?' " **JOHN 21:15**
- 9 ACROSS "...He said to Him, 'Yes, Lord; You know that I love You.' He said to him, '_____ My lambs.' " **JOHN 21:15**
- 6 DOWN "He said to him again a second time, 'Simon, son of Jonah, do you love Me?' He said to Him, 'Yes, Lord; You know that I love You.' He said to him, '_____ My sheep.' " **JOHN 21:16**
- 4 ACROSS "He said to him the third time, 'Simon, son of Jonah, do you love Me?' Peter was _____ because He said to him the third time, 'Do you love Me?'..." **JOHN 21:17**
- 7 DOWN "...And he said to Him, 'Lord, You know _____ things; You know that I love You.'..." **JOHN 21:17**
- 1 DOWN "...Jesus said to him, 'Feed My _____.' " **JOHN 21:17**
- 2 ACROSS "Most assuredly, I say to you, when you were younger, you girded yourself and walked where you wished; but when you are old, you will stretch out your _____, and another will gird you and carry you where you do not wish." **JOHN 21:18**
- 4 DOWN "This He spoke, signifying by what death he would _____ God..." **JOHN 21:19**
- 8 ACROSS "...And when He had spoken this, He said to him, '_____ Me.' " **JOHN 21:19**

Bible Story 244

THE ASCENSION

LUKE 24:44-53

244. THE ASCENSION (LUKE 24:44-53)



"And it came to pass, while he blessed them, he was parted from them, and carried up into heaven."
LUKE 24:51

244. THE ASCENSION

(LUKE 24:44-53)

MEMORY VERSE:

"Now it came to pass, while He blessed them, that He was parted from them and carried up into heaven." LUKE 24:51

CIRCLE THE CORRECT WORD:

1. "Then He said to them, 'These are the words which I spoke to you while I was still with you, that all things must be (**FULFILLED, FORGOTTEN**) which were written in the Law of Moses and the Prophets and the Psalms concerning Me.'" **LUKE 24:44**

TRUE OR FALSE:

2. "And He opened their understanding, that they might comprehend the Scriptures." **LUKE 24:45**
TRUE OR FALSE
3. "Then He said to them, 'Thus it is written, and thus it was necessary for the Christ to suffer and to rise from the dead the third day.'" **LUKE 24:46**
TRUE OR FALSE

FILL IN THE BLANK:

4. "And that repentance and remission of _____ should be preached in His name to all nations, beginning in Jerusalem." **LUKE 24:47**

TRUE OR FALSE:

5. "And You are witnesses of these things." **LUKE 24:48**
TRUE OR FALSE

CIRCLE THE CORRECT WORDS:

6. "Behold, I send the Promise of My Father upon you; but tarry in the city of (**JERICHO, JERUSALEM**) until you are endued with power from on high." **LUKE 24:49**
7. "Now it came to pass, while He blessed them, that He was parted from them and carried up into (**THE MOUNTAINS, HEAVEN**)." **LUKE 24:51**

TRUE OR FALSE:

8. "And they worshiped Him, and returned to Jerusalem with great joy..." **LUKE 24:52**
TRUE OR FALSE

CIRCLE THE CORRECT WORD:

9. "...and were (**NEVER, CONTINUALLY**) in the temple praising and blessing God. Amen." **LUKE 24:53**

244. THE ASCENSION

(LUKE 24:44-53)

C E Q N D P S A L M S S D P Y
C H U B S L R I S E A U Y O M
L D R S U E O M P U M F N L T
P Y E I C G S H J U R F A T Y
P A N P S R P O E S B E H P R
R Q T E P T I R M B N R T Y R
O A N W V I Q P O F Y Q E O A
M O V O I A H E T P O P B J T
I Y S Y I T E S H U H W R N D
S E E Z E S N H R Y R E A R E
E A T A D C S E D O N E T L S
A E L P M E T I S J W L S S S
W O R D S M R S M S M J M A E
R E P E N T A N C E E D J P L
I E K B K N U Z C G R S L L B

BEHOLD
BETHANY
BLESSED
CHRIST
HEAVEN
JOY
LAW OF MOSES

PROMISE
PROPHETS
PSALMS
REMISSION
REPENTANCE
RISE
SCRIPTURES

SUFFER
TARRY
TEMPLE
WITNESSES
WORDS
WORSHIP



244. THE ASCENSION

(LUKE 24:44-53)

MEMORY VERSE:

"Now it came to pass, while He blessed them, that He was parted from them and carried up into heaven." LUKE 24:51

FILL IN THE BLANK:

1. "Then He said to them, 'These are the words which I spoke to you while I was still with you, that all things must be _____ which were written in the Law of Moses and the Prophets and the Psalms concerning Me.' " **LUKE 24:44**

TRUE OR FALSE:

2. "And He opened their understanding, that they might comprehend the Scriptures." **LUKE 24:45**
TRUE OR FALSE
3. "Then He said to them, 'Thus it is written, and thus it was necessary for the Christ to suffer and to rise from the dead the third day.' " **LUKE 24:46**
TRUE OR FALSE

FILL IN THE BLANK:

4. "And that repentance and remission of _____ should be preached in His name to all nations, beginning in Jerusalem." **LUKE 24:47**

TRUE OR FALSE:

5. "And You are witnesses of these things." **LUKE 24:48**
TRUE OR FALSE

FILL IN THE BLANKS:

6. "Behold, I send the Promise of My Father upon you; but tarry in the city of _____ until you are endued with power from on high." **LUKE 24:49**
7. "Now it came to pass, while He blessed them, that He was parted from them and carried up into _____." **LUKE 24:51**

TRUE OR FALSE:

8. "And they worshiped Him, and returned to Jerusalem with great joy..." **LUKE 24:52**
TRUE OR FALSE

CIRCLE THE CORRECT WORD:

9. "...and were continually in the temple _____ and _____ God. Amen." **LUKE 24:53**

244. THE ASCENSION

(LUKE 24:44-53)



C E Q N D P S A L M S S D P Y
C H U B S L R I S E A U Y O M
L D R S U E O M P U M F N L T
P Y E I C G S H J U R F A T Y
P A N P S R P O E S B E H P R
R Q T E P T I R M B N R T Y R
O A N W V I Q P O F Y Q E O A
M O V O I A H E T P O P B J T
I Y S Y I T E S H U H W R N D
S E E Z E S N H R Y R E A R E
E A T A D C S E D O N E T L S
A E L P M E T I S J W L S S S
W O R D S M R S M S M J M A E
R E P E N T A N C E E D J P L
I E K B K N U Z C G R S L L B

BEHOLD
BETHANY
BLESSED
CHRIST
HEAVEN
JOY
LAW OF MOSES

PROMISE
PROPHETS
PSALMS
REMISSION
REPENTANCE
RISE
SCRIPTURES

SUFFER
TARRY
TEMPLE
WITNESSES
WORDS
WORSHIP

244. THE ASCENSION (LUKE 24:44-53)

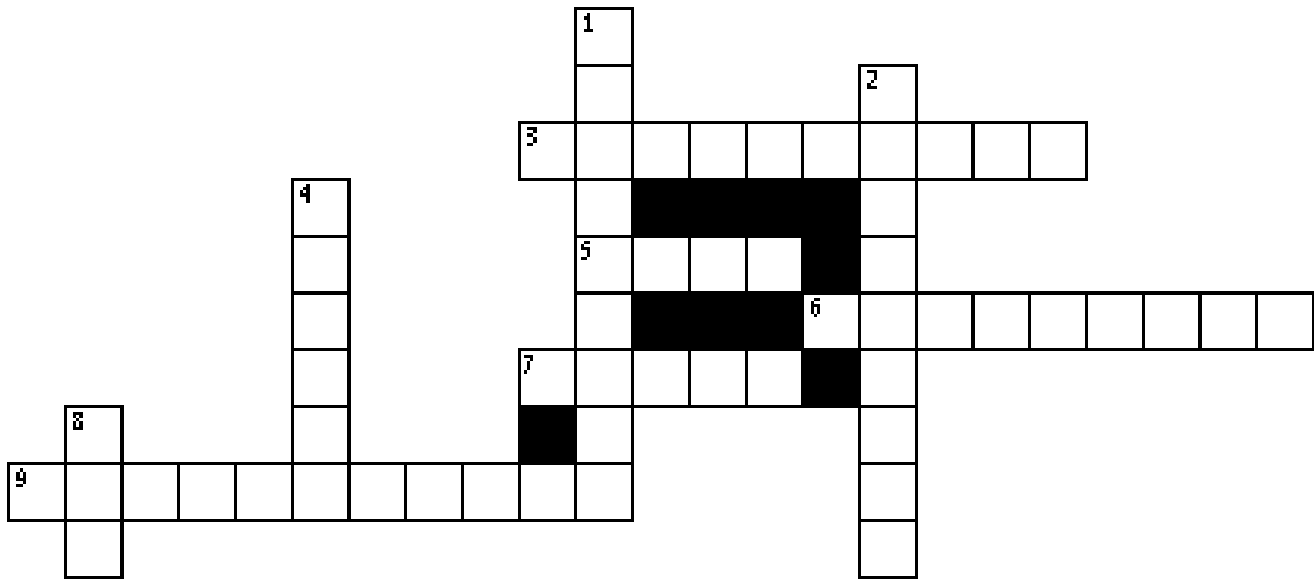

- 2 DOWN "Then He said to them, 'These are the words which I spoke to you while I was still with you, that all things must be _____ which were written in the Law of Moses and the Prophets and the Psalms concerning Me.'" **LUKE 24:44**
- 3 ACROSS "And He opened their understanding, that they might comprehend the _____." **LUKE 24:45**
- 1 DOWN "Then He said to them, 'Thus it is written, and thus it was _____ for the Christ to suffer and to rise from the dead the third day.'" **LUKE 24:46**
- 5 ACROSS "And that repentance and remission of _____ should be preached in His name to all nations, beginning in Jerusalem." **LUKE 24:47**
- 6 ACROSS "And You are _____ of these things." **LUKE 24:48**
- 7 ACROSS "Behold, I send the Promise of My Father upon you; but _____ in the city of Jerusalem until you are endued with power from on high." **LUKE 24:49**
- 4 DOWN "Now it came to pass, while He blessed them, that He was parted from them and carried up into _____." **LUKE 24:51**
- 8 DOWN "And they worshiped Him, and returned to Jerusalem with great _____." **LUKE 24:52**
- 9 ACROSS "...and were _____ in the temple praising and blessing God. Amen." **LUKE 24:53**

Bible Story 245

**THE
DAY OF
PENTECOST**

Acts 2:1-41



"On the Day of Pentecost the disciples are filled with the Holy Spirit"
Acts 2:1 – 41

245. THE DAY OF PENTECOST

(ACTS 2:1-41)

MEMORY VERSE:

"And they were all filled with the Holy Spirit and began to speak with other tongues, as the Spirit gave them utterance." ACTS 2:4

TRUE OR FALSE:

1. "Now when the Day of Pentecost had fully come, they were all with one accord in one place." **ACTS 2:1**
TRUE OR FALSE

CIRCLE THE CORRECT WORDS:

2. "And suddenly there came a sound from heaven, as of a rushing mighty (**RHINOCEROS, WIND**), and it filled the whole house where they were sitting." **ACTS 2:2**
3. "Then there appeared to them divided tongues, as of (**FIRE, ICE**), and one sat upon each of them." **ACTS 2:3**

FILL IN THE BLANKS:

4. *"And they were all filled with the _____ and began to speak with other tongues, as the Spirit gave them utterance." ACTS 2:4*

CIRCLE THE CORRECT WORDS:

5. "Now there were dwelling in Jerusalem Jews, devout men, from every nation under heaven. And when this sound occurred, the multitude came together, and were (**HAPPY, CONFUSED**), because everyone heard them speak in his own language." **ACTS 2:5-6**
6. "So they were all amazed and perplexed, saying to one another, 'Whatever could this mean?' Others mocking said, 'They are full of new wine.' But Peter, standing up with the eleven, raised his voice and said to them, 'Men of Judea and all who dwell in Jerusalem, let this be known to you, and heed my words. For these are not drunk, as you suppose, for it is only the third hour of the day. But this is what was spoken by the prophet (**ISAIAH, JOEL**).' " **ACTS 2:12-16**

TRUE OR FALSE:

7. "Therefore let all the house of Israel know assuredly that God has made this Jesus, whom you crucified, both Lord and Christ." **ACTS 2:36**
TRUE OR FALSE
8. "Now when they heard this, they were cut to the heart, and said to Peter and the rest of the apostles, 'Men and brethren, what shall we do?' " **ACTS 2:37**
TRUE OR FALSE

CIRCLE THE CORRECT WORDS:

9. "Then Peter said to them, '(**REPENT, REBEL**), and let every one of you be baptized in the name of Jesus Christ for the remission of sins; and you shall receive the gift of the Holy Spirit.' " **ACTS 2:38**
10. "Then those who gladly received his word were baptized; and that day about three (**HUNDRED, THOUSAND**) souls were added to them." **ACTS 2:41**

245. THE DAY OF PENTECOST

(ACTS 2:1-41)

L A N G U A G E V J J F A D F
 T T Z S B B B E O R I B A F I
 L F H D E B A E O R E Y E S E
 R M V R U D L P E F O P E A O
 N C Q A E E U G T F Y U E T Z
 E R Q M Q E D T P I G H I N E
 V R E A J O T E I N Z R D K T
 A E S Z A N N H O T I E B Q R
 E T U E D T V T O P L G D S I
 H E O D E S Z I S U O U I W Y
 F P H C U R D Y V D S Q M Y M
 F I O S I N L V O B T A Z U S
 Z S E E U O R M O C K I N G I
 T J U O H L K M F I L L E D L
 R P S B O M I G H T Y W I N D

AMAZED
 BAPTIZED
 DAY OF PENTECOST
 FILLED
 FIRE
 GOD
 HEAVEN

HOLY SPIRIT
 HOUSE
 JESUS
 JOEL
 LANGUAGE
 MIGHTY WIND
 MOCKING

MULTITUDE
 PETER
 REPENT
 SOUND
 THREE THOUSAND
 TONGUES

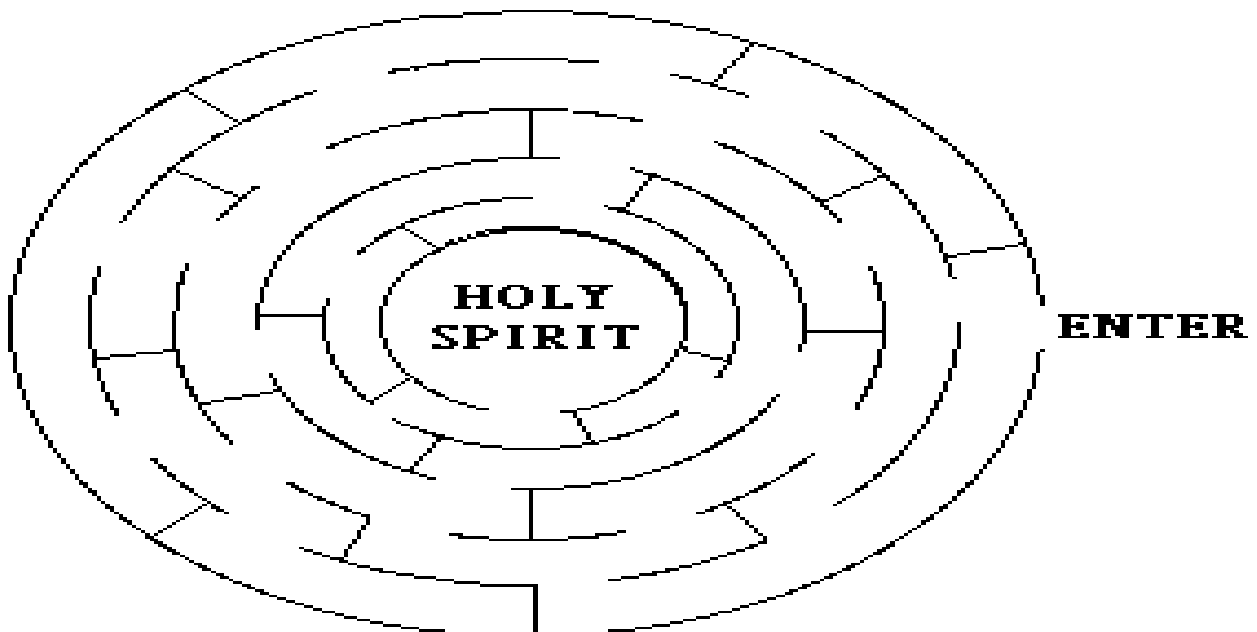

245. THE DAY OF PENTECOST

(ACTS 2:1-41)

MEMORY VERSE:

"And they were all filled with the Holy Spirit and began to speak with other tongues, as the Spirit gave them utterance." ACTS 2:4

TRUE OR FALSE:

1. "Now when the Day of Pentecost had fully come, they were all with one accord in one place." **ACTS 2:1**
TRUE OR FALSE

FILL IN THE BLANKS:

2. "And suddenly there came a sound from heaven, as of a rushing mighty _____, and it filled the whole house where they were sitting." **ACTS 2:2**
3. "Then there appeared to them divided tongues, as of _____, and one sat upon each of them." **ACTS 2:3**
4. "And they were all filled with the _____ and began to speak with other tongues, as the Spirit gave them utterance." **ACTS 2:4**
5. "Now there were dwelling in Jerusalem Jews, devout men, from every nation under heaven. And when this sound occurred, the multitude came together, and were _____, because everyone heard them speak in his own language." **ACTS 2:5-6**
6. "So they were all amazed and perplexed, saying to one another, 'Whatever could this mean?' Others mocking said, 'They are full of new wine.' But Peter, standing up with the eleven, raised his voice and said to them, 'Men of Judea and all who dwell in Jerusalem, let this be known to you, and heed my words. For these are not drunk, as you suppose, for it is only the third hour of the day. But this is what was spoken by the _____.'" **ACTS 2:12-16**

TRUE OR FALSE:

7. "Therefore let all the house of Israel know assuredly that God has made this Jesus, whom you crucified, both Lord and Christ." **ACTS 2:36**
TRUE OR FALSE

8. "Now when they heard this, they were cut to the heart, and said to Peter and the rest of the apostles, 'Men and brethren, what shall we do?'" **ACTS 2:37**
TRUE OR FALSE

FILL IN THE BLANKS:

9. "Then Peter said to them, '_____, and let every one of you be baptized in the name of Jesus Christ for the remission of sins; and you shall receive the gift of the Holy Spirit.'" **ACTS 2:38**
10. "Then those who gladly received his word were baptized; and that day about _____ souls were added to them." **ACTS 2:41**

245. THE DAY OF PENTECOST

(ACTS 2:1-41)

L A N G U A G E V J J F A D F
T T Z S B B B E O R I B A F I
L F H D E B A E O R E Y E S E
R M V R U D L P E F O P E A O
N C Q A E E U G T F Y U E T Z
E R Q M Q E D T P I G H I N E
V R E A J O T E I N Z R D K T
A E S Z A N N H O T I E B Q R
E T U E D T V T O P L G D S I
H E O D E S Z I S U O U I W Y
F P H C U R D Y V D S Q M Y M
F I O S I N L V O B T A Z U S
Z S E E U O R M O C K I N G I
T J U O H L K M F I L L E D L
R P S B O M I G H T Y W I N D

AMAZED
BAPTIZED
DAY OF PENTECOST
FILLED
FIRE
GOD
HEAVEN

HOLY SPIRIT
HOUSE
JESUS
JOEL
LANGUAGE
MIGHTY WIND
MOCKING

MULTITUDE
PETER
REPENT
SOUND
THREE THOUSAND
TONGUES

245. THE DAY OF PENTECOST

(ACTS 2:1-41)

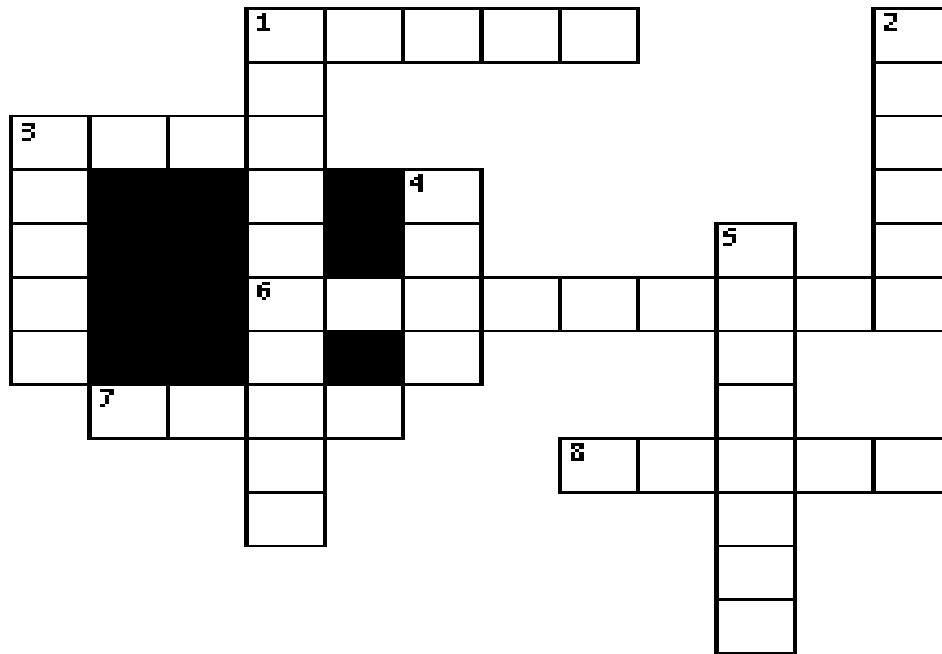

- 6 ACROSS "Now when the Day of _____ had fully come, they were all with one accord in one place." **ACTS 2:1**
- 4 DOWN "And suddenly there came a sound from heaven, as of a rushing mighty _____, and it filled the whole house where they were sitting." **ACTS 2:2**
- 7 ACROSS "Then there appeared to them divided tongues, as of _____, and one sat upon each of them." **ACTS 2:3**
- 1 DOWN "And they were all filled with the _____ _____ and began to speak with other tongues, as the Spirit gave them utterance." **ACTS 2:4**
- 5 DOWN "And when this sound occurred, the multitude came together, and were _____, because everyone heard them speak in his own language." **ACTS 2:6**
- 3 ACROSS "...this is what was spoken by the prophet _____." **ACTS 2:16**
- 3 DOWN "Therefore let all the house of Israel know assuredly that God has made this _____, whom you crucified, both Lord and Christ." **ACTS 2:36**
- 1 ACROSS "Now when they heard this, they were cut to the _____, and said to Peter and the rest of the apostles, 'Men and brethren, what shall we do?' " **ACTS 2:37**
- 2 DOWN "Then Peter said to them, '_____, and let every one of you be baptized in the name of Jesus Christ for the remission of sins; and you shall receive the gift of the Holy Spirit.' " **ACTS 2:38**
- 8 ACROSS "Then those who gladly received his word were baptized; and that day about three thousand _____ were added to them." **ACTS 2:41**

Bible Story 246

THE EARLY CHURCH

Acts 2:42-47; 4:32-37



"Those in the early church did continue daily with one accord in the temple, broke bread from house to house, ate their food with gladness and simplicity of heart, praised God and had favor with all the people." Acts 2:46-47

246. THE EARLY CHURCH

(ACTS 2:42-47; 4:32-37)

MEMORY VERSE:

"And they continued steadfastly in the apostles' doctrine and fellowship, in the breaking of bread, and in prayers." ACTS 2:42

UNDERLINE THE CORRECT ANSWER:

1. "And they continued steadfastly in..." **ACTS 2:42**
 - a. the apostles' doctrine
 - b. fellowship
 - c. the breaking of bread
 - d. prayers
 - e. all of the above

TRUE OR FALSE:

2. "Now all who believed were together, and had all things in common, and sold their possessions and goods, and divided them among all, as anyone had need." **ACTS 2:44-45**
TRUE OR FALSE
3. "And the Lord added to the church daily those who were being saved." **ACTS 2:47**
TRUE OR FALSE
4. Now the multitude of those who believed were of many hearts and souls. **ACTS 4:32**
TRUE OR FALSE

CIRCLE THE CORRECT WORDS:

5. "And with great (**FEAR, POWER**) the apostles gave witness to the resurrection of the Lord Jesus..." **ACTS 4:33**
6. "...And great (**GRACE, CONDEMNATION**) was upon them all." **ACTS 4:33**
7. "Nor was there anyone among them who (**ATE, LACKED**); for all who were possessors of lands or houses sold them, and brought the proceeds of the things that were sold, and laid them at the apostles feet; and they distributed to each as anyone had need." **ACTS 4:34-35**

246. THE EARLY CHURCH

(ACTS 2:42-47; 4:32-37)

D U B L S B L A D R F W S E L
 O D S W C D W V Y E B L M M S
 C S U J H D K D D F V A C S R
 T J H U U C I Q J E D A Z E E
 R H P I H S W O L L E F S L D
 I Q P U E O J E I J B P L T N
 N O R O C K B R E A D P B S O
 E C E E N Q S N P O K A T O W
 H Y L T S A F D A E T S M P P
 V E V P Q D E D I V I D O A M
 M W R E H T E G O T K B S B C
 F D A I L Y U R T U A V N N C
 P O S S E S S I O N S Q G O V
 S E A T L K E Y V G T D I B Z
 W B R C S R E Y A R P V S U B

APOSTLES
 BREAD
 CHURCH
 DAILY
 DIVIDED

DOCTRINE
 FELLOWSHIP
 POSSESSIONS
 PRAYERS
 SAVED

SIGNS
 STEADFASTLY
 TOGETHER
 WONDERS

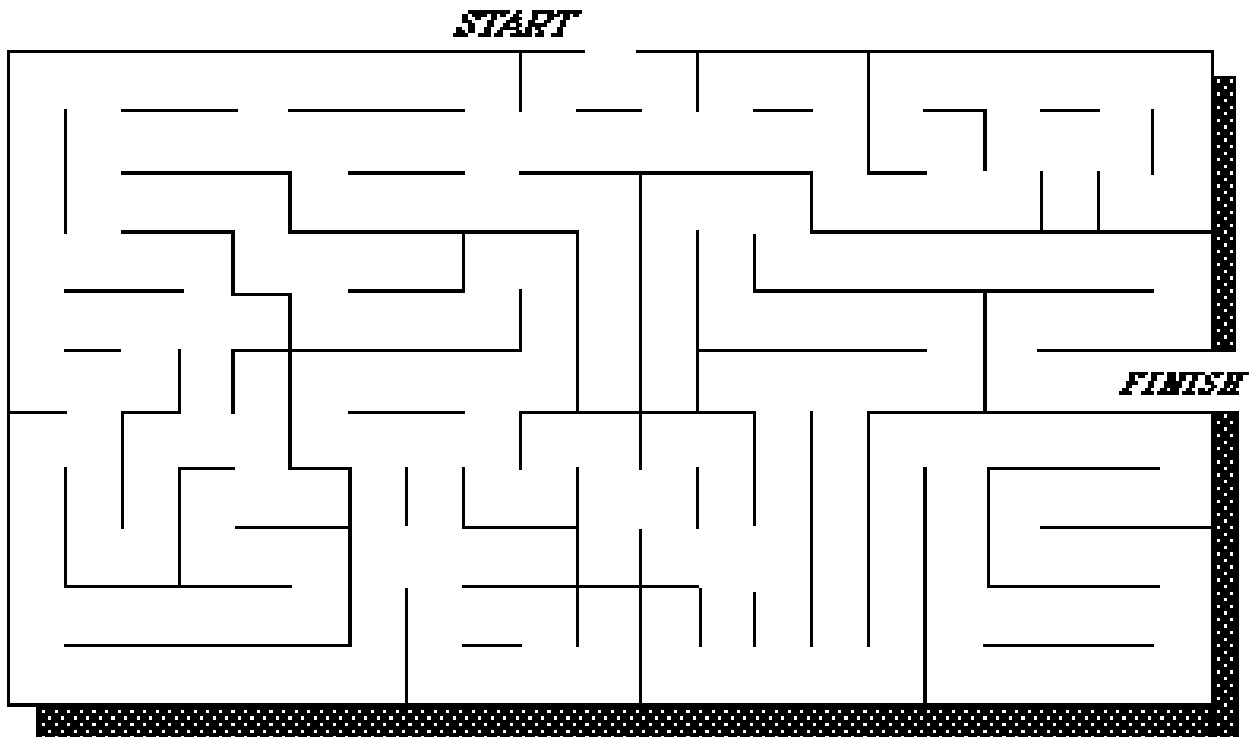

246. THE EARLY CHURCH

(ACTS 2:42-47; 4:32-37)

MEMORY VERSE:

"And they continued steadfastly in the apostles' doctrine and fellowship, in the breaking of bread, and in prayers." ACTS 2:42

UNDERLINE THE CORRECT ANSWER:

1. "And they continued steadfastly in..." **ACTS 2:42**
 - a. the apostles' doctrine
 - b. fellowship
 - c. the breaking of bread
 - d. prayers
 - e. all of the above

FILL IN THE BLANK:

2. "Now all who _____ were together, and had all things in common, and sold their possessions and goods, and divided them among all, as anyone had need." **ACTS 2:44-45**

TRUE OR FALSE:

3. "And the Lord added to the church daily those who were being saved." **ACTS 2:47**
TRUE OR FALSE
4. Now the multitude of those who believed were of many hearts and souls. **ACTS 4:32**
TRUE OR FALSE

FILL IN THE BLANKS:

5. "And with great _____ the apostles gave witness to the resurrection of the Lord Jesus..."
ACTS 4:33
6. "...And great _____ was upon them all." **ACTS 4:33**
7. "Nor was there anyone among them who _____; for all who were possessors of lands or houses sold them, and brought the proceeds of the things that were sold, and laid them at the apostles feet; and they distributed to each as anyone had _____." **ACTS 4:34-35**

246. THE EARLY CHURCH

(ACTS 2:42-47; 4:32-37)

F P W K Q M D C B B J D O J K E M A G J N R E F U M D V A S
 H Q D E D I V I D O T S L S D M B V F P H T F R A A A Q F S
 N F B E R B W G B I P O E U B B P B Y Q E E S N U B Y B I A
 G H P F I S Y R U T R J P E K N C P Q Q B D U A Y T T S I M L
 B P E J L V P G B D L H T A K O D R D G B S G M E O G P I Y
 G J S T S O Z N C E J Q C V A B T A C Q N S Q Z B N M O O J
 R T A D D E D G B J C O S D T U B Y M F Y I F U O B B R Q H
 Q B G E T J W Z M K V E C Q W L B E P G B F S I O V T A H W
 I G D J D R O C C A E N O E L P G R O A B J H I P E L V U Z
 P I L Z F J B J D K T W H N A M E S E M J S W B A F A K N A
 H A E A C E M P L P W E U R P C I O A M M G B N F R B R H P
 Z M P Z D H W N S Z H B E Y P C B U Y A V R I M D G P W P X
 I B Z K A N U U V H P K C Y A V B V U R E H T E G O T Y U I
 C T C C Y A E R R Y O S N D B S P Z H O W A K C H S H B Y C
 O Y C T Y W U S C Y J U Q J V Z T A A K Z S E D D L P G N N
 M L Q I O L F O S H H U S I Q K P E E C F F Y N F C U P M Z
 M I S N O I S E S S O P L E D F B B A Y I N B Y W Y V F H F
 O O I O B Z I F C O Q H K P V K Z E C D Z T T E Y D L Q B N
 N V W T F E B L M J O P D T S S V F N U F Q I N S T R K Y F
 V Q Z A V B L L L A A E D V M M F P A D T A O I H L R G A P
 V Z K N B P G I P F W V O R C O R T I Y M C S R K E E B O G
 B U K R S J Y O E A E A K F Z S K O Z G G D W T T V A Q M G
 Q A Q P V H S M B V V L Q E I A K N S T S Y A C L P V R B Z
 Y N J I M T P S B H E R P G L T Y I N R G R E O E Y U L T A
 E F E L L O W S H I P D N M U M R J E I R Q P D F T V J H B
 L M B E A G Y Z A A M S K J E Z G D C I H T Q D A E R B N K
 N G S Q Z E B F C H F L L O T T N J Z P B B T J Y J P V B O
 V F B D S U D P W Z S W W U M O I Y B G V K F D R I I U V M
 Q H R Y L I A D J Y W J K G W J K T R C Y I V V N P R B I Y
 T A B J H W R G B N U U I F O S U H P J Y J I C L K F E U S

ADDED
 APOSTLES
 BELIEVED
 BREAD
 CHURCH
 COMMON
 DAILY
 DIVIDED

DOCTRINE
 FELLOWSHIP
 GLADNESS
 HEART
 HOUSE
 LORD
 ONE ACCORD
 POSSESSIONS

PRAISING
 PRAYERS
 SIGNS
 STEADFASTLY
 TEMPLE
 TOGETHER
 WONDERS

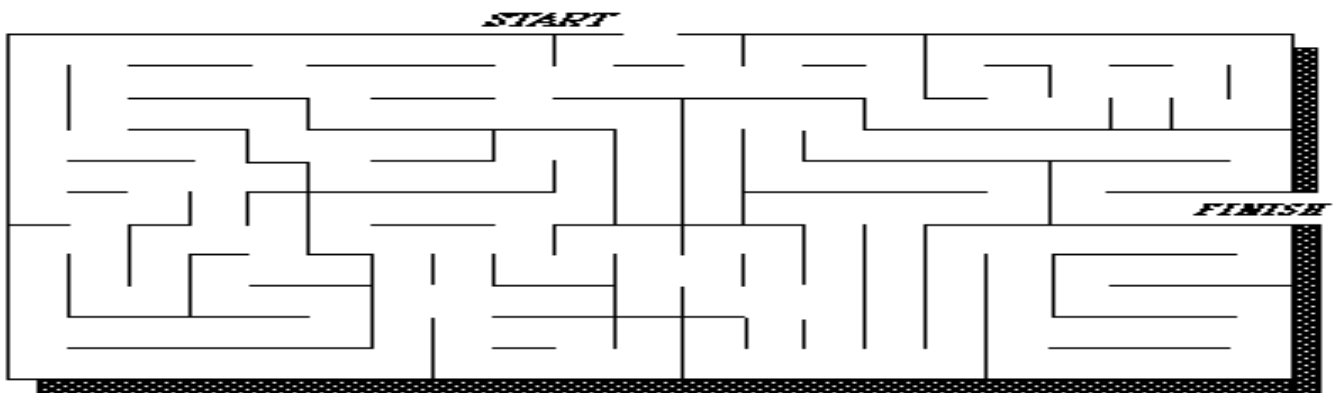

246. THE EARLY CHURCH (ACTS 2:42-47; 4:32-37)

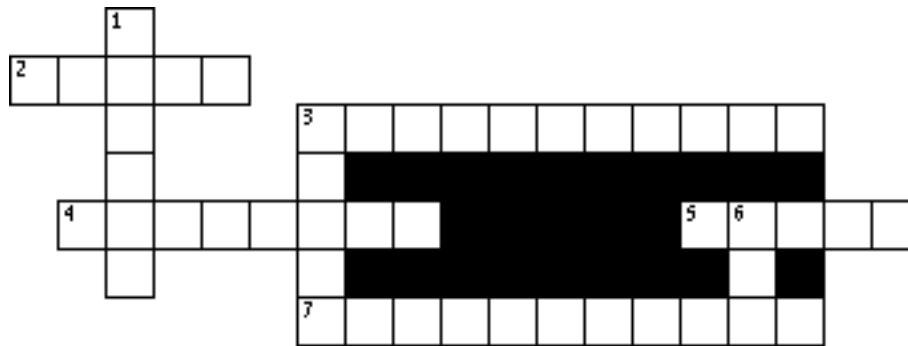

- 3 ACROSS "And they continued _____ in the apostles' doctrine and fellowship, in the breaking of bread, and in prayers." **ACTS 2:42**
- 4 ACROSS "Now all who _____ were together, and had all things in common, and sold their possessions and goods, and divided them among all, as anyone had need." **ACTS 2:44-45**
- 3 DOWN "And the Lord added to the church daily those who were being _____." **ACTS 2:47**
- 6 DOWN "Now the multitude of those who believed were of _____ heart and one soul." **ACTS 4:32**
- 5 ACROSS "And with great _____ the apostles gave witness to the resurrection of the Lord Jesus..." **ACTS 4:33**
- 2 ACROSS "...And great _____ was upon them all." **ACTS 4:33**
- 1 DOWN "Nor was there anyone among them who _____..." **ACTS 4:34**
- 7 ACROSS " for all who were possessors of lands or houses sold them, and brought the proceeds of the things that were sold, and laid them at the apostles feet; and they _____ to each as anyone had need." **ACTS 4:34-35**

Bible Story 247

**PETER & JOHN
HEAL
A LAME MAN**

Acts 3:1-26

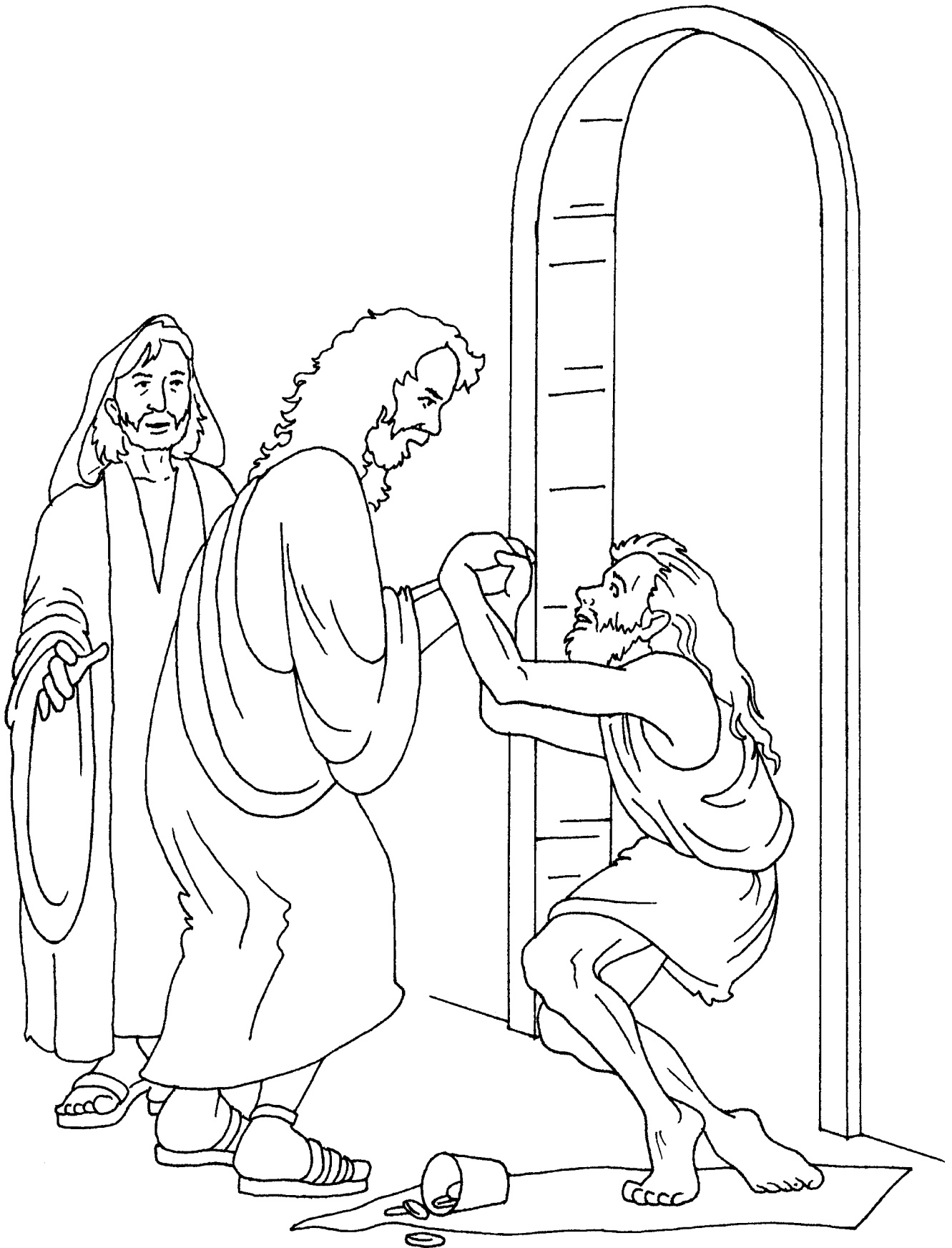

"Peter and John heal a lame man." Acts 3:1-26

247. PETER AND JOHN HEAL A LAME MAN

(ACTS 3:1-26)

MEMORY VERSE:

"Then Peter said, 'Silver and gold I do not have, but what I do have I give you: In the name of Jesus Christ of Nazareth, rise up and walk.' " ACTS 3:6

UNDERLINE THE CORRECT ANSWER:

1. "Now Peter and John went up together..." **ACTS 3:1**
 - a. to the market
 - b. to the temple at the hour of prayer, the ninth hour

TRUE OR FALSE:

2. "And a certain man lame from his mother's womb was carried, whom they laid daily at the gate of the temple which is called Beautiful, to ask alms from those who entered the temple." **ACTS 3:2**
TRUE OR FALSE
3. "Then Peter said, 'Silver and gold I do not have, but what I do have I give you: In the name of Jesus Christ of Nazareth, rise up and walk.' " **ACTS 3:6**
TRUE OR FALSE

CIRCLE THE CORRECT WORDS:

4. "So he, (**LEAPING, CREEPING**) up, stood and walked and entered the temple with them, walking, leaping, and praising God." **ACTS 3:8**
5. "Now as the lame man who was healed held on to Peter and John, all the people ran together to them in the porch which is called Solomon's, greatly (**AFRAID, AMAZED**)." **ACTS 3:11**
6. "So when Peter saw it, he responded to the people: 'Men of Israel, why do you (**MARBLE, MARVEL**) at this? Or why look so intently at us, as though by our own power or godliness we had made this man walk?' " **ACTS 3:12**
7. "**(REPENT, REBEL)** therefore and be converted, that your sins may be blotted out, so that times of refreshing may come from the presence of the Lord." **ACTS 3:19**

TRUE OR FALSE:

8. "To you first, God, having raised up His servant Jesus, sent Him to bless you, in turning away every one of you from your iniquities." **ACTS 3:26**
TRUE OR FALSE

247. PETER AND JOHN HEAL A LAME MAN

(ACTS 3:1-26)

S O E W R P G G M L W E Y P J
T J U B C O L K D B J J Y L N
R J W F D R L B L B U B O D H
E E D I G I R E V L I S J E O
N A G N I S I A R P B B F T J
G W W B R E M U S W O P A F H
T L Y G G N S K V A A Z H I Q
H Z P Y N U Z D L O G L A L O
S T S I R H C S U S E J K J A
H B Z P G H C R O P I E H C W
M P R E Y A R P R C T L Z V P
B J W Y Z O F B B S L P Y T E
B E A U T I F U L M A M N W T
S H B B J F P U M L M E J H E
V G M D Y L I A D A E T T P R

ALMS
BEAUTIFUL
DAILY
GOD
GOLD
JESUS CHRIST

JOHN
LAME
LIFTED
PETER
PORCH
PRAISING

PRAYER
RISE
SILVER
STRENGTH
TEMPLE
WALK

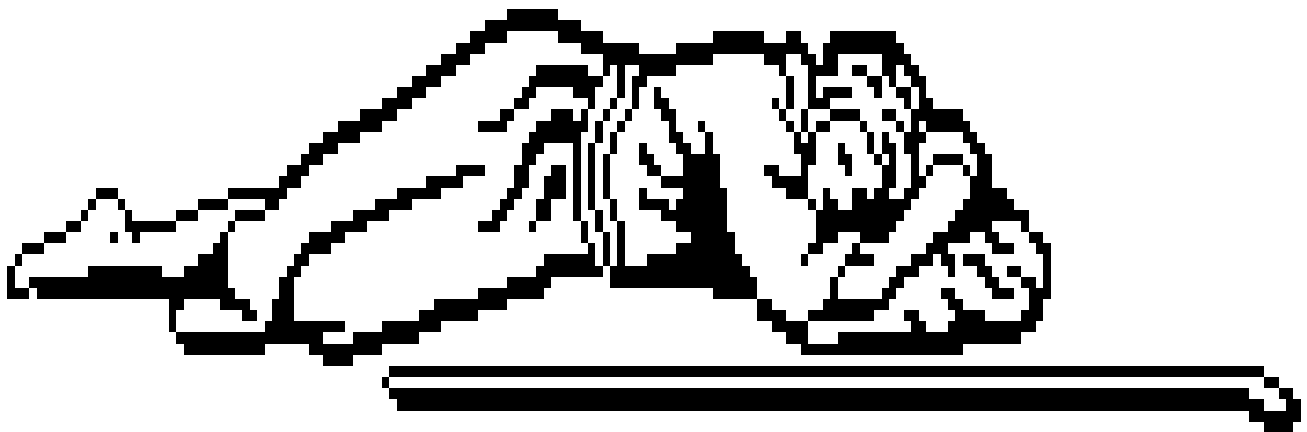

247. PETER AND JOHN HEAL A LAME MAN

(ACTS 3:1-26)

MEMORY VERSE:

"Then Peter said, 'Silver and gold I do not have, but what I do have I give you: In the name of Jesus Christ of Nazareth, rise up and walk.' "ACTS 3:6

UNDERLINE THE CORRECT ANSWER:

1. "Now Peter and John went up together..." **ACTS 3:1**
 - a. to the market
 - b. to the temple at the hour of prayer, the ninth hour

TRUE OR FALSE:

2. "And a certain man lame from his mother's womb was carried, whom they laid daily at the gate of the temple which is called Beautiful, to ask alms from those who entered the temple." **ACTS 3:2**
TRUE OR FALSE
3. "Then Peter said, 'Silver and gold I do not have, but what I do have I give you: In the name of Jesus Christ of Nazareth, rise up and walk.' " **ACTS 3:6**
TRUE OR FALSE

FILL IN THE BLANKS:

4. "So he, _____ up, stood and walked and entered the temple with them, walking, leaping, and praising God." **ACTS 3:8**
5. "Now as the lame man who was healed held on to Peter and John, all the people ran together to them in the porch which is called Solomon's, greatly _____." **ACTS 3:11**
6. "So when Peter saw it, he responded to the people: 'Men of Israel, why do you _____ at this? Or why look so intently at us, as though by our own power or godliness we had made this man walk?' " **ACTS 3:12**
7. " _____ therefore and be converted, that your sins may be blotted out, so that times of refreshing may come from the presence of the Lord." **ACTS 3:19**

TRUE OR FALSE:

8. "To you first, God, having raised up His servant Jesus, sent Him to bless you, in turning away every one of you from your iniquities." **ACTS 3:26**
TRUE OR FALSE

247. PETER AND JOHN HEAL A LAME MAN (ACTS 3:1-26)

A O D E A P B Z B W U H F Q H B S O C Z V G O J U N H S P E
 R F C Y B R D S P D V Y Q J N C R J N V B B L D B Z G E J P C
 K G Z T R F V D R K F G B J J F J V M R K K T F E R P T C N C V
 H Q R E B M N G Y A I M H C G N J N G B G D W Q Q B E Q R Q V
 I C D Z E E P P R G U B M B I B D R I M P P U W R A J G A T
 T F Y Q W T Y J E S H U G V E L U M K S E T U D P K W W B S
 J C Q V G L O C B A D E T F I L V I F H I C Y U P W L K M B
 H J Q L F H G V V U I V Q D G L C F T J N P O A R O Q G M Q
 B K H S N M N U T K P E G I W D G J E J A N L B A Y P Q J B
 C V F R Z E W I H S K Z O M K N O S S L V B P C Y K W N L M
 G O O S A E Y P O C R U L O O K U Q T B I I Z Q E Z E G F I
 H B I B N L R I S E R U D O I S Q E O B W V P K R U T H Z T
 G Y H B S P Z N J Y E O S F C A A P Y K A G Z H P M F W A N
 Q D H Z H M U S Q B N M P H L U E G S I L V E R I P O Z P B
 P G Q F U E G C L F L I R S D W G G T N M U A C Y G R G M P
 C C B W S T F N P A A I W U N K A L T P H I B H V K U V B Y
 P B F B Y Z Y P V L S B G D S O T Y G F S K F L N L A K R P
 Q E U Y J G O D G T I Q B I U Y M T F I L J P U W W M C Z Z
 B K M L N I I C Y K P B W V J Y N O N H A W T A E B Q U F I
 V Y N N D I F B Q I Q Y D E L E B G L J Z B E A U T I F U L
 L B V D Y D B C D Q F V L M J H K P I O Y S S B H K P E I C
 I Z S C I Z L B O E M A L I T L L V Y K S F A B Z N B T A B
 J K L V B P A P O S R B I N A B D E M Z E Z W D J I T N B K
 C U L O L Z E R K S C W C B B D O N R W K Z I V Q I H R N L
 J F B A O V Z E P H T G N E R T S J A W G E L Z B C J G V W
 H J M S W U C M Z O G Y P A V R H A U V Z S V Y M J M Q A F
 L U I K U D L H S E O B L S Q O Y H V H S G U O G H U A O I
 Q B O L P W W Y T Z W K O P O W Q N W W B Y A R B M N F W W
 H K B D W E C Y V P J Y P W V H K Y A S E M G C H U N W E K
 Y B K B C E A M G E V H D J Y J G W T R W B O C P J R E T O

ALMS
 BEAUTIFUL
 DAILY
 GOD
 GOLD
 JESUS CHRIST

JOHN
 LAME
 LIFTED
 PETER
 PRAISING
 PRAYER

RISE
 SILVER
 SOLOMON'S PORCH
 STRENGTH
 TEMPLE
 WALK



247. PETER AND JOHN HEAL A LAME MAN (ACTS 3:1-26)

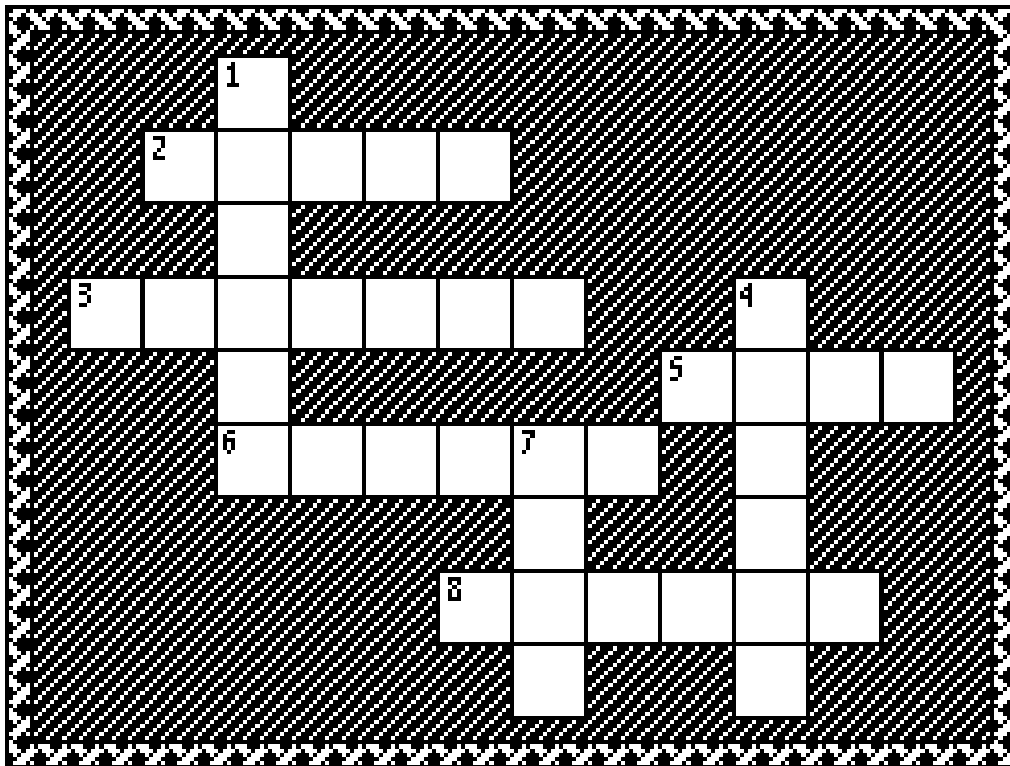

- 6 ACROSS "Now Peter and John went up together to the _____ at the hour of prayer, the ninth hour." **ACTS 3:1**
- 7 DOWN "And a certain man _____ from his mother's womb was carried, whom they laid daily at the gate of the temple which is called Beautiful, to ask alms from those who entered the temple." **ACTS 3:2**
- 5 ACROSS "Then Peter said, 'Silver and gold I do not have, but what I do have I give you: In the name of Jesus Christ of Nazareth, rise up and _____.'" **ACTS 3:6**
- 3 ACROSS "So he, _____ up, stood and walked and entered the temple with them, walking, leaping, and praising God." **ACTS 3:8**
- 8 ACROSS "Now as the lame man who was healed held on to Peter and John, all the people ran together to them in the porch which is called Solomon's, greatly _____." **ACTS 3:11**
- 4 DOWN "So when Peter saw it, he responded to the people: 'Men of Israel, why do you _____ at this? Or why look so intently at us, as though by our own power or godliness we had made this man walk?' " **ACTS 3:12**
- 1 DOWN "_____ therefore and be converted, that your sins may be blotted out, so that times of refreshing may come from the presence of the Lord." **ACTS 3:19**
- 2 ACROSS "To you first, God, having raised up His servant _____, sent Him to bless you, in turning away every one of you from your iniquities." **ACTS 3:26**

Bible Story 248

**PETER & JOHN
ARRESTED
AND RELEASED**

Acts 4:1-31

248. PETER AND JOHN ARRESTED AND RELEASED (ACTS 4:1-31)

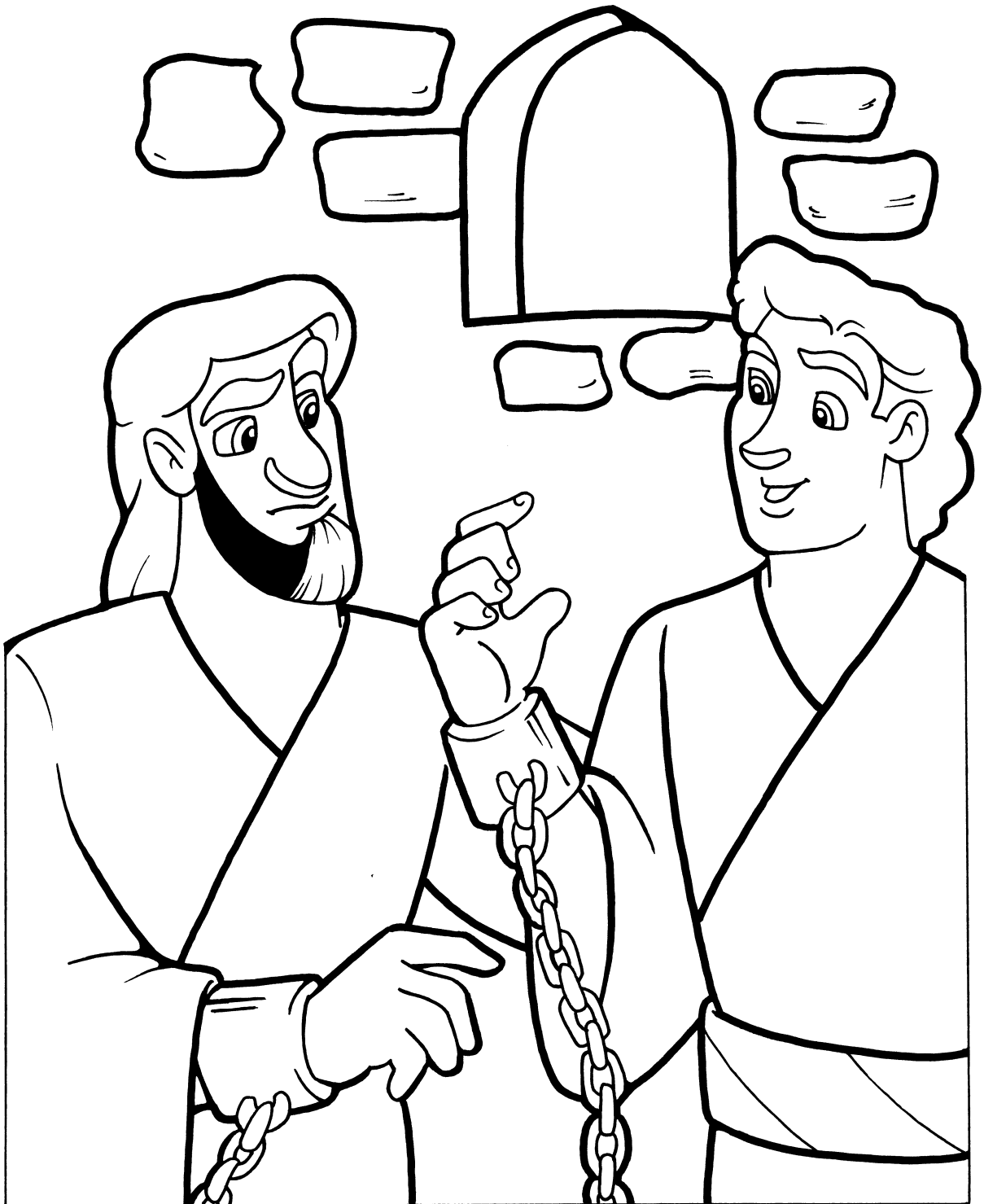

" And they laid hands on them, and put *them* in hold unto the next day: for it was now eventide."

ACTS 4:3

248. PETER AND JOHN ARRESTED AND RELEASED (ACTS 4:1-31)

MEMORY VERSE:

"Now when they saw the boldness of Peter and John, and perceived that they were uneducated and untrained men, they marveled. And they realized that they had been with Jesus." ACTS 4:13

TRUE OR FALSE:

1. "Now as they spoke to the people, the priests, the captain of the temple, and the Sadducees came upon them, being greatly disturbed that they taught the people and preached in Jesus the resurrection from the dead." **ACTS 4:1-2**

TRUE OR FALSE

2. "And they laid hands on them, and put them in custody until the next day, for it was already evening." **ACTS 4:3**

TRUE OR FALSE

CIRCLE THE CORRECT WORDS:

3. "However, many of those who heard the word believed; and the number of the men came to be about five (**HUNDRED, THOUSAND**)." **ACTS 4:4**
4. "And when they had set them in the midst, they asked, 'By what power or by what (**NAME, BLAME**) have you done this?' " **ACTS 4:7**
5. "Now when they saw the boldness of Peter and John, and perceived that they were uneducated and untrained men, they marveled. And they realized that they had been with (**SCHOLARS, JESUS**)." **ACTS 4:13**

TRUE OR FALSE:

6. "And seeing the man who had been healed standing with them, they could say nothing against it." **ACTS 4:14**

TRUE OR FALSE

7. And they called them and commanded them to speak and teach in the name of Jesus. **ACTS 4:18**

TRUE OR FALSE

CIRCLE THE CORRECT WORD:

8. "So when they had further threatened them, they let them go, finding no way of punishing them, because of the people, since they all glorified (**GOD, CAIAPHAS**) for what He had done." **ACTS 4:21**

TRUE OR FALSE:

9. "And being let go, they went to their own companions and reported all that the chief priests and elders had said to them." **ACTS 4:23**

TRUE OR FALSE

10. "And when they had prayed, the place where they were assembled together was shaken; and they were all filled with the Holy Spirit, and they spoke the word of God with boldness." **ACTS 4:31**

TRUE OR FALSE

248. PETER AND JOHN ARRESTED AND RELEASED (ACTS 4:1-31)

S S D B K V U I R C Y C C T F
 A M C R Y B E D H E U N E J N
 D O D P O O F O G M T M Z M I
 D A T P R L P G F P P E B E A
 U T T I R I P S Y L O H P L T
 C M B U G U T J E J O H N A P
 E Z B Z I V H E A L E D R S A
 E J G V K Z O J Y O H A P U C
 S N O I T C E R R U S E R R G
 V S E F B S S E N D L O B E A
 Z M D E I F I R O L G I S J M
 K P R A Y E D Y Q E A Z U P M
 F I V E T H O U S A N D S Q A
 F B I R A A N B D A E S E B O
 K P K K L I C N U O C N J Q K

BOLDNESS

CAPTAIN

COUNCIL

FIVE THOUSAND

GLORIFIED

GOD

HEALED

HOLY SPIRIT

JERUSALEM

JESUS

JOHN

LORD

PETER

PRAYED

RESURRECTION

SADDUCEES

TEMPLE

248. PETER AND JOHN ARRESTED AND RELEASED

(ACTS 4:1-31)

MEMORY VERSE:

"Now when they saw the boldness of Peter and John, and perceived that they were uneducated and untrained men, they marveled. And they realized that they had been with Jesus." ACTS 4:13

TRUE OR FALSE:

1. "Now as they spoke to the people, the priests, the captain of the temple, and the Sadducees came upon them, being greatly disturbed that they taught the people and preached in Jesus the resurrection from the dead." **ACTS 4:1-2**

TRUE OR FALSE

2. "And they laid hands on them, and put them in custody until the next day, for it was already evening." **ACTS 4:3**

TRUE OR FALSE

FILL IN THE BLANKS:

3. "However, many of those who heard the word believed; and the number of the men came to be about _____." **ACTS 4:4**
4. "And when they had set them in the midst, they asked, 'By what _____ or by what _____ have you done this?' " **ACTS 4:7**
5. "Now when they saw the boldness of Peter and John, and perceived that they were uneducated and untrained men, they marveled. And they realized that they had been with _____." **ACTS 4:13**

TRUE OR FALSE:

6. "And seeing the man who had been healed standing with them, they could say nothing against it." **ACTS 4:14**

TRUE OR FALSE

7. And they called them and commanded them to speak and teach in the name of Jesus. **ACTS 4:18**

TRUE OR FALSE

FILL IN THE BLANKS:

8. "So when they had further threatened them, they let them go, finding no way of punishing them, because of the people, since they all glorified _____ for what He had done." **ACTS 4:21**
9. "And being let go, they went to their own _____ and reported all that the chief priests and elders had said to them." **ACTS 4:23**

TRUE OR FALSE:

10. "And when they had prayed, the place where they were assembled together was shaken; and they were all filled with the Holy Spirit, and they spoke the word of God with boldness." **ACTS 4:31**

TRUE OR FALSE

248. PETER AND JOHN ARRESTED AND RELEASED (ACTS 4:1-31)

E V R A N O J P W C L V S U G S V U E J E E U D H B B M Z R
 L G B V A B B N A H B B P I H Q A Y M B Y A M D D I K B F B
 M S O C S H S B F R F B T I B U E E J B U E E R R V M Z N I
 G N S A S F M B B S P A W G L O R I F I E D S M S S I U B U
 M B L U L V R C T R S D B B V M I E Q K W Q Z J M M U I A Q
 B K S D P I J E A E L E H R S J S J V J I U P L B B B J D H
 P E K L R O T Y S M Y D N W U Q G A E K D O G P U I W L P C
 J K W O U O E D O U H W J D B L J V V U A T J O R E T E P C
 M O V Z T D L W M Q R T Y G L J P K V M C M E L A S U R E J
 W J J M N N A K J N B R K T H O Z U L B L V H L R R V M U N
 N Q B F D H A I K Y O L E B U T B O A Y H S D T S B B P B U
 G S W M R I U E G M I A P C Q W F Z I R O E C S J Q G B I B
 K P E Q A U E P H A R O N W T K B B L T L T U E L Y P E B S
 B M L S Z A N I G S F A B I T I B A R T Y B U E P C H C R U
 Y B V Q E F Q Y D V Y P K I A M O M B C S N S C B Z J O H N
 K B D V M F B B V Y B A G U P T K N B M P B Y U N A K H Q N
 P O T P D T N B F B D D P M L L P Z C P I Y J D S K H M I E
 U H D E W Q A P B I F Y S F J U M A Q M R Z G D L R C B J S
 Y S Z B M H Y P G W V S O O B G Z B C L I A A A P V O I L B
 F S Z Q Q P Q Y C L B E T E J C B T N C T B B S H Z V V J T
 K R O J B A L F Z W E M T D E L A E H L P U R P L Y N M V I
 T V W I I U U E H W H U W H H V I P R I A E B N Q E J T R L
 G N H C T U Q O K Z T B I P O U Z Z B C I D N R U H L Q R E
 E G Q T A T T J K O L S H K T U F F B N E K Y A I Z D V B I
 Y D I C L T H W R A U E J J J B S V B U Y G N P C C R U J A
 G P L J B D T S E K W J D F Y N Z A I O A C M L C S Z G S B
 M K H W Z D T S N U Q M U Y R H B F N C Q M Q Y M G B B F Q
 Q S T Y Z Q R I C N N G O T D B D H F D A N P M R I Y D Q Y
 H B Y J N C R A V U I O L W C A K N W S O Q L T B F A O V R
 V B O T B U W G C D S V O U G U B E L G Y R J F G L E N B B

BOLDNESS
CAPTAIN
COUNCIL
FIVE THOUSAND
GLORIFIED
GOD

HEALED
HOLY SPIRIT
JERUSALEM
JESUS
JOHN
LORD

PETER
PRAYED
RESURRECTION
SADDUCEES
TEMPLE

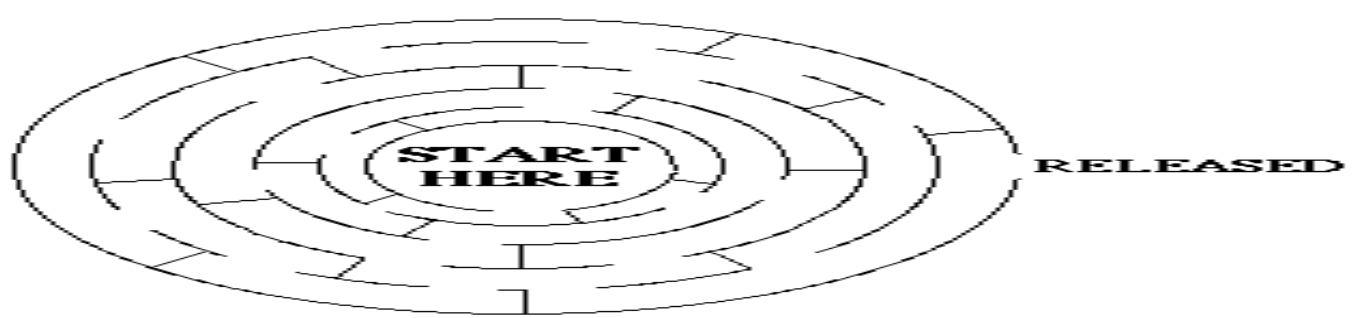

248. PETER AND JOHN ARRESTED AND RELEASED (ACTS 4:1-31)

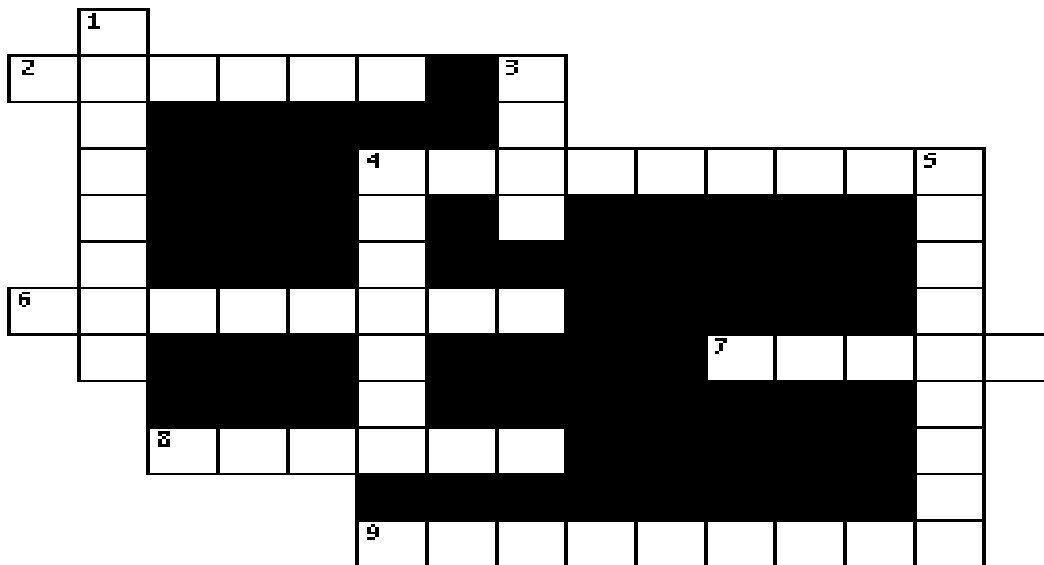

- 5 DOWN "Now as they spoke to the people, the priests, the captain of the temple, and the Sadducees came upon them, being greatly _____ that they taught the people and preached in Jesus the resurrection from the dead." **ACTS 4:1-2**
- 4 DOWN "And they laid hands on them, and put them in _____ until the next day, for it was already evening." **ACTS 4:3**
- 1 DOWN "However, many of those who heard the word _____; and the number of the men came to be about five thousand." **ACTS 4:4**
- 3 DOWN "And when they had set them in the midst, they asked, 'By what power or by what _____ have you done this?' " **ACTS 4:7**
- 7 ACROSS "Now when they saw the boldness of Peter and John, and perceived that they were uneducated and untrained men, they marveled. And they realized that they had been with _____." **ACTS 4:13**
- 2 ACROSS "And seeing the man who had been _____ standing with them, they could say nothing against it." **ACTS 4:14**
- 4 ACROSS "And they called them and _____ them not to speak at all nor teach in the name of Jesus." **ACTS 4:18**
- 9 ACROSS "So when they had further threatened them, they let them go, finding no way of punishing them, because of the people, since they all _____ God for what He had done." **ACTS 4:21**
- 6 ACROSS "And being let go, they went to their own companions and _____ all that the chief priests and elders had said to them." **ACTS 4:23**
- 8 ACROSS "And when they had _____, the place where they were assembled together was shaken; and they were all filled with the Holy Spirit, and they spoke the word of God with boldness." **ACTS 4:31**

Bible Story 249

**ANANIAS
& SAPPHIRA**

Acts 5:1-11

249. ANANIAS AND SAPPHIRA (ACTS 5:1-11)



"But a certain man named Ananias, with Sapphira his wife, sold a possession, and kept back *part* of the price, his wife also being privy *to it*, and brought a certain part, and laid *it* at the apostles' feet."

ACTS 5:1-2

249. ANANIAS AND SAPPHIRA

(ACTS 5:1-11)

MEMORY VERSE:

"And through the hands of the apostles many signs and wonders were done among the people. And they were all with one accord in Solomon's Porch." ACTS 5:12

CIRCLE THE CORRECT WORD:

1. "But a certain man named Ananias, with Sapphira his wife, sold a (POSSESSION, DECISION)." ACTS 5:1

TRUE OR FALSE:

2. "And he kept back part of the proceeds, his wife also being aware of it, and brought a certain part and laid it at the apostles' feet." ACTS 5:2

TRUE OR FALSE

3. "But Peter said, 'Ananias, why has Satan filled your heart to lie to the Holy Spirit and keep back part of the price of the land for yourself?' " ACTS 5:3

TRUE OR FALSE

CIRCLE THE CORRECT WORDS:

4. "While it remained, was it not your own? And after it was sold, was it not in your own control? Why have you conceived this thing in your heart? You have not lied to men but to (WOMEN, GOD)." ACTS 5:4

5. "Then Ananias, hearing these words, fell down and (BREATHED, LIED) his last." ACTS 5:5

6. "Now it was about three (HOURS, DAYS) later when his wife came in, not knowing what happened." ACTS 5:7

TRUE OR FALSE:

7. And Peter answered her, "Tell me whether you sold the land for so much?" And she said, "No, not that much." ACTS 5:8

TRUE OR FALSE

CIRCLE THE CORRECT WORDS:

8. "Then immediately she fell down at his feet and (BREATHED, LIED) her last. And the young men came in and found her dead, and carrying her out, buried her by her husband." ACTS 5:10

9. "So great (JOY, FEAR) came upon all the church and upon all who heard these things." ACTS 5:11

249. ANANIAS AND SAPPHIRA

(ACTS 5:1-11)

A G S M B T L A L H U E S P E
P N Z D A A Y H J Q D B U T R
O G F L N E Y Z C O S K H S A
S Z P D C J O Y V A J B P A E
T J A R I H P P A S H U E I F
L P G S W B J N T W Q R V N C
E N K V J B F J W V O I A A N
S U B R U P A T R A P E R N Q
B T I R I P S Y L O H D L A L
D O B B K N A B A S E H W I L
R F R E T E P B H M W C E C H
C L K M O Z H P P F S R J S E
P O S S E S S I O N O U U C A
G L C L I E F I W S L H O H R
R M U B D A E D J W D C E U T

ANANIAS
APOSTLES
BURIED
CHURCH
DEAD
FEAR

HEART
HOLY SPIRIT
LAND
LIE
PART
PETER

POSSESSION
SAPPHIRA
SOLD
WIFE

THE LIE BEGINS HERE

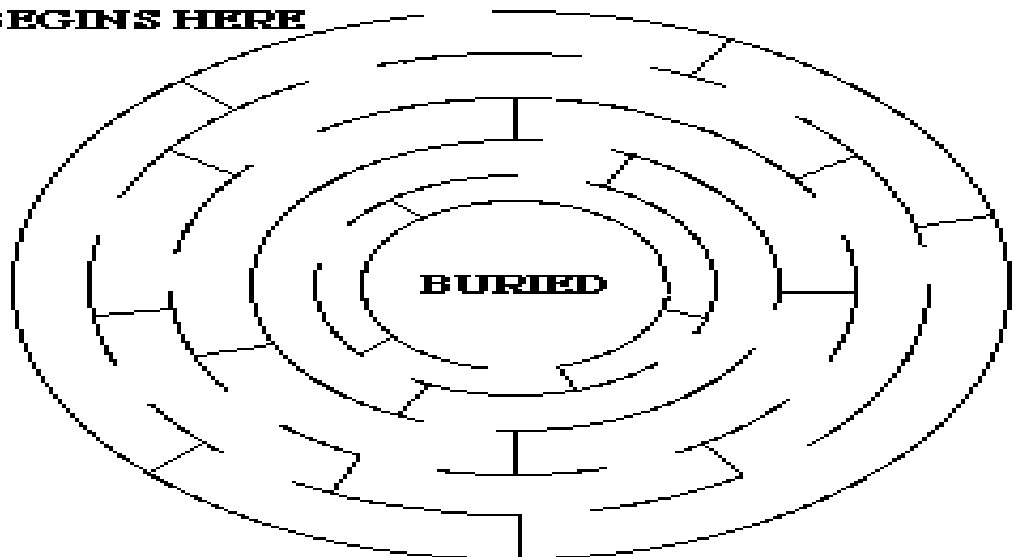

249. ANANIAS AND SAPPHIRA

(ACTS 5:1-11)

MEMORY VERSE:

"And through the hands of the apostles many signs and wonders were done among the people. And they were all with one accord in Solomon's Porch." ACTS 5:12

FILL IN THE BLANK:

1. "But a certain man named Ananias, with Sapphira his wife, sold a _____."
ACTS 5:1

TRUE OR FALSE:

2. "And he kept back part of the proceeds, his wife also being aware of it, and brought a certain part and laid it at the apostles' feet." **ACTS 5:2**
TRUE OR FALSE
3. "But Peter said, 'Ananias, why has Satan filled your heart to lie to the Holy Spirit and keep back part of the price of the land for yourself?' " **ACTS 5:3**
TRUE OR FALSE

FILL IN THE BLANKS:

4. "While it remained, was it not your own? And after it was sold, was it not in your own control? Why have you conceived this thing in your heart? You have not lied to men but to _____." **ACTS 5:4**
5. "Then Ananias, hearing these words, fell down and _____ his last." **ACTS 5:5**
6. "Now it was about three _____ later when his wife came in, not knowing what happened." **ACTS 5:7**

TRUE OR FALSE:

7. And Peter answered her, "Tell me whether you sold the land for so much?" And she said, "No, not that much." **ACTS 5:8**
TRUE OR FALSE

FILL IN THE BLANKS:

8. "Then immediately she fell down at his feet and _____ her last. And the young men came in and found her dead, and carrying her out, buried her by her husband." **ACTS 5:10**
9. "So great _____ came upon all the church and upon all who heard these things."
ACTS 5:11

249. ANANIAS AND SAPPHIRA

(ACTS 5:1-11)

C G U M B F B V F S Y K S I Y F C H V O L Q K K P
 G Q B N B A L U B C R P A U G Q B N Y W D E F E R
 H B B V Z B O D L N E Z U H M B V F B H O P T B V
 G F B S F R U W A P B S K I B H D G C J H E T M B
 Q C D L W F P E E C V T S P U M I I J S R G S S K
 P J C B E B W E S A I N A N A G A E N R C G T H G
 C K Z A B E C B Z E P V Y K V P M G B V H L O J P
 P V R M Y W P T C I A G B R O Q O W L J U Y Y L E
 Q O R I D G R D I L R W F S E W O K L D R T T B I
 B B D O E D E A D R T D T E Z G F O D U C P T B N
 V Y Y B I F F V L B I L L N U H E A R T H V G K A
 L D Q K R Z M N W C E P K A U B U I N V Y E F N V
 I G Q E U A E P C S T K S I I W D L K C Q N I P I
 J C H Y B N T Y A B O A I Y B D I D A G K J Y F W
 C B F T W I F E Z P J G Q P L I V S U O G A M H A
 J E O E L S L G S R Q N S Q Q O E U W Q O H R J M
 S O L D N H M N D E L O S F B C H S A P P H I R A
 H K I Z D U E W G M P I O R V P M J K A J N A K H
 L Y H Q C S Z Y P H V S E C B L N L Y E M Y U Z L
 D B H V V Y I Z C Y G S Z G W O B J Y G N W V W A
 Q N Q L O J I U V Y Y E P O Y P A T E A R C W W Z
 H Z A B B N D G U M Q S E W U D S B H T M N A V Y
 Y U U L K D Z F I B D S U J K Q P V L N I R T H E
 O F F R L Y P Y P Z O O V V Y J W Q B B F G Z W K
 F J U S D I Z I N R O P F H H J J O R K J I V S G

ANANIAS
 APOSTLES
 BURIED
 CHURCH
 DEAD
 FEAR

HEART
 HOLY SPIRIT
 LAND
 LIE
 PART

PETER
 POSSESSION
 SAPPHIRA
 SOLD
 WIFE

THE LIE BEGINS HERE

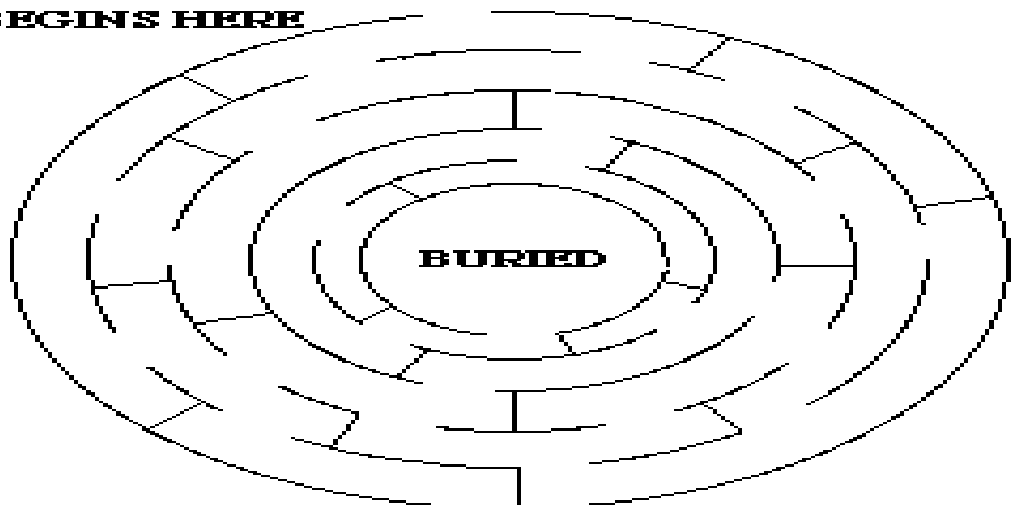

249. ANANIAS AND SAPPHIRA

(ACTS 5:1-11)

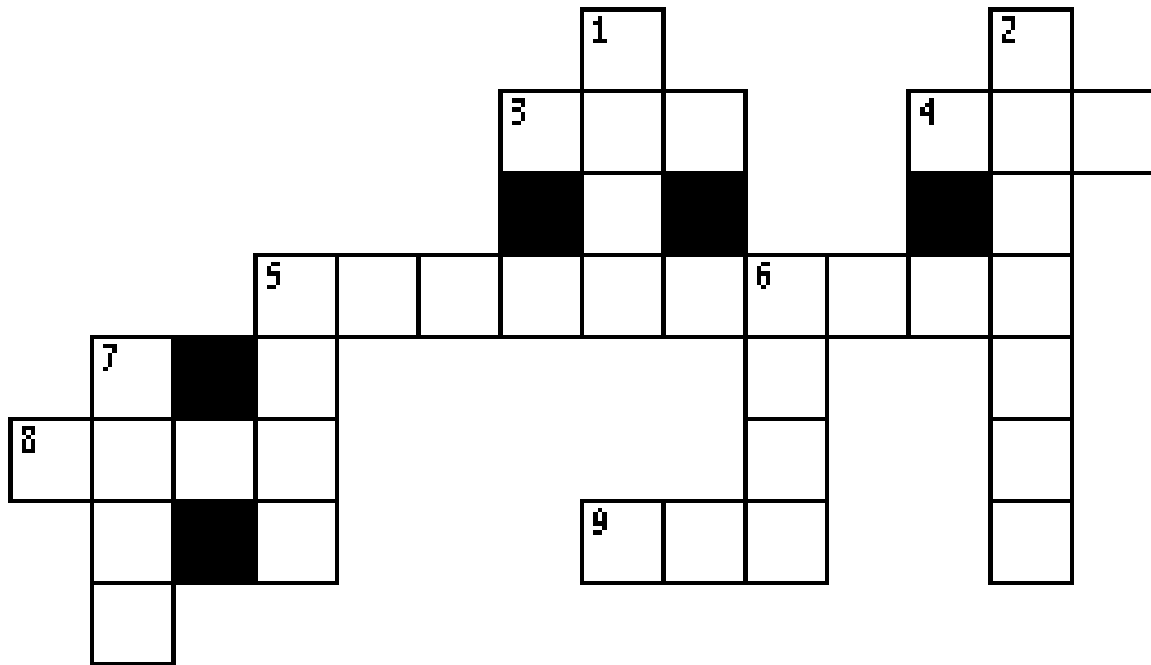

- 5 ACROSS "But a certain man named Ananias, with Sapphira his wife, sold a ____." **ACTS 5:1**
- 5 DOWN "And he kept back part of the proceeds, his wife also being aware of it, and brought a certain ____ and laid it at the apostles' feet." **ACTS 5:2**
- 3 ACROSS "But Peter said, 'Ananias, why has Satan filled your heart to ____ to the Holy Spirit and keep back part of the price of the land for yourself?' " **ACTS 5:3**
- 9 ACROSS "While it remained, was it not your own? And after it was sold, was it not in your own control? Why have you conceived this thing in your heart? You have not lied to men but to ____." **ACTS 5:4**
- 2 DOWN "Then ____, hearing these words, fell down and breathed his last." **ACTS 5:5**
- 1 DOWN "Now it was about three hours later when his ____ came in, not knowing what happened." **ACTS 5:7**
- 6 DOWN "And Peter answered her, 'Tell me whether you ____ the land for so much?' And she said, 'Yes, for so much.' " **ACTS 5:8**
- 7 DOWN "Then immediately she fell down at his feet and breathed her last. And the young men came in and found her ____, and carrying her out, buried her by her husband." **ACTS 5:10**
- 8 ACROSS "So great ____ came upon all the church and upon all who heard these things." **ACTS 5:11**
- 4 ACROSS "And through the hands of the apostles many signs and wonders were done among the people. And they were all with ____ accord in Solomon's Porch." **ACTS 5:12**

Bible Story 250

STEPHEN

Acts 6:1 - 8:2

250. STEPHEN
(ACTS 6:2-8:2)



"And they stoned Stephen, calling upon *God*, and saying, Lord Jesus, receive my spirit."
ACTS 7:59

250. STEPHEN

(ACTS 6:2-8:2)

MEMORY VERSE:

"And the word of God spread, and the number of the disciples multiplied greatly in Jerusalem, and a great many of the priests were obedient to the faith. And Stephen, full of faith and power, did great wonders and signs among the people." ACTS 6:7-8

TRUE OR FALSE:

1. "Then the twelve summoned the multitude of the disciples and said, 'It is not desirable that we should leave the word of God and serve tables.'" **ACTS 6:2**
TRUE OR FALSE

CIRCLE THE CORRECT WORD:

2. "Therefore, brethren, seek out from among you seven men of good reputation, full of the Holy Spirit and wisdom, whom we may appoint over this business; but we will give ourselves (**CONTINUALLY, OCCASIONALLY**) to prayer and to the ministry of the word." **ACTS 6:3-4**

TRUE OR FALSE:

3. "And the word of God spread, and the number of the disciples multiplied greatly in Jerusalem, and a great many of the priests were obedient to the faith." **ACTS 6:7**
TRUE OR FALSE
4. "And Stephen, full of faith and power, did great wonders and signs among the people." **ACTS 6:8**
TRUE OR FALSE
5. "Then there arose some from what is called the Synagogue of the Freedmen...disputing with Stephen." **ACTS 6:9**
TRUE OR FALSE

CIRCLE THE CORRECT WORD:

6. "And they stirred up the people, the elders, and the scribes; and they came upon him, seized him, and brought him to the (**JAIL, COUNCIL**)."
ACTS 6:12

UNDERLINE THE CORRECT ANSWER:

7. "Then they..." **ACTS 7:57-58**
 - a. cried out with a loud voice
 - b. stopped their ears
 - c. ran at him with one accord
 - d. cast him out of the city
 - e. stoned him
 - f. all of the above

TRUE OR FALSE:

8. "And they stoned Stephen as he was calling on God and saying, 'Lord Jesus, receive my spirit.' Then he knelt down and cried out with a loud voice, 'Lord, do not charge them with this sin.' And when he had said this, he fell asleep." **ACTS 7:59-60**
TRUE OR FALSE

250. STEPHEN

(ACTS 6:1-8:2)

W H I G H P R I E S T S V T N
 I Z S M E N S R B E S E C I N
 T F C A A H Y D S S G I P D B
 N P R H V E N S N S J Z J L C
 E E I L E H A T G E N E E C L
 S E B E N R G O I N B D S L O
 S L E U E P O N S T O O U B T
 E S S W S Q G E R I F S S A H
 L A O R T F U D J W R R A D E
 P P T U E M E E F E T E F U S
 O O V E P F D S D S I D A P L
 E G C W H G A L H L R N N R A
 P A A G E G E I P A I O G H Q
 F C O U N C I L T F P W E Q H
 W I S D O M C S M H S L L B C

ANGEL
 ASLEEP
 CLOTHES
 COUNCIL
 ELDERS
 FACE

FAITH
 FALSE WITNESSES
 HEAVEN
 HIGH PRIEST
 JESUS
 PEOPLE

POWER
 SAUL
 SCRIBES
 SEIZED
 SIGNS
 SPIRIT

STEPHEN
 STONED
 SYNAGOGUE
 WISDOM
 WITNESS
 WONDERS

START

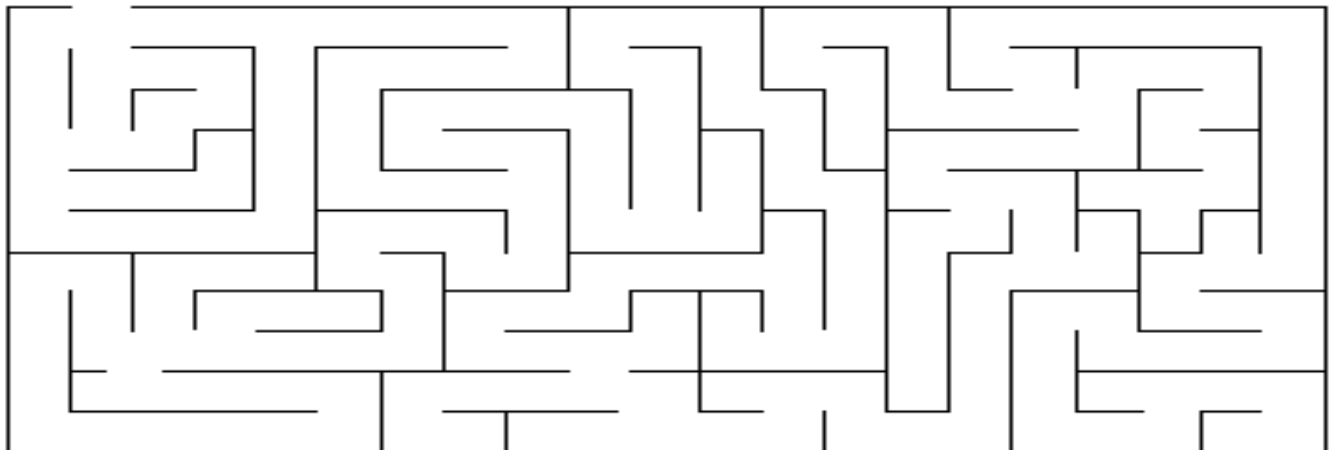

FINISH

250. STEPHEN

(ACTS 6:2-8:2)

MEMORY VERSE:

"And the word of God spread, and the number of the disciples multiplied greatly in Jerusalem, and a great many of the priests were obedient to the faith. And Stephen, full of faith and power, did great wonders and signs among the people." ACTS 6:7-8

TRUE OR FALSE:

1. "Then the twelve summoned the multitude of the disciples and said, 'It is not desirable that we should leave the word of God and serve tables.'" **ACTS 6:2**
TRUE OR FALSE

FILL IN THE BLANK:

2. "Therefore, brethren, seek out from among you seven men of good reputation, full of the Holy Spirit and wisdom, whom we may appoint over this business; but we will give ourselves _____ to prayer and to the ministry of the word." **ACTS 6:3-4**

TRUE OR FALSE:

3. "And the word of God spread, and the number of the disciples multiplied greatly in Jerusalem, and a great many of the priests were obedient to the faith." **ACTS 6:7**
TRUE OR FALSE
4. "And Stephen, full of faith and power, did great wonders and signs among the people." **ACTS 6:8**
TRUE OR FALSE

FILL IN THE BLANKS:

5. "Then there arose some from what is called the _____ of the Freedmen...disputing with Stephen." **ACTS 6:9**
6. "And they stirred up the people, the elders, and the scribes; and they came upon him, seized him, and brought him to the _____." **ACTS 6:12**
7. "But he, being full of the _____, gazed into heaven and saw the glory of God, and Jesus standing at the right hand of God, and said, 'Look! I see the heavens opened and the Son of Man standing at the right hand of God!' " **ACTS 7:55-56**

UNDERLINE THE CORRECT ANSWER:

8. "Then they..." **ACTS 7:57-58**
 - a. cried out with a loud voice
 - b. stopped their ears
 - c. ran at him with one accord
 - d. cast him out of the city
 - e. stoned him
 - f. all of the above

TRUE OR FALSE:

9. "And they stoned Stephen as he was calling on God and saying, 'Lord Jesus, receive my spirit.' Then he knelt down and cried out with a loud voice, 'Lord, do not charge them with this sin.' And when he had said this, he fell asleep." **ACTS 7:59-60**
TRUE OR FALSE

250. STEPHEN

(ACTS 6:1-8:2)

O J M R H A D F E Z B P K U P M B J Q B E E E D R I B B N Q
 J B Q A I U W B N O E A G M L L B A V K Y Q S R S V K Z B H
 Q W S Z U E K T C A H D P F J B K V E J U U Z M M S M U A C
 S E Q E A N I O V L W Y S W I T N E S S W T P J C M I I D C
 P L V M F Q F M C I I S O O B G C K V K I V J L B K B J P N
 M V P T F B E A S K T C T E J C L B V U A S H P R I B L U U
 B D B D I N P D L B L M N P H P O W E R E R E L P O E P W M K K
 B D Q W T R O J C S B U W U T V T O L M C E D O D E N O T S
 O Z J Q Q M I K H N E B I K O U H Z A B L S R E D N O W I S
 H Z I B H A I P R U W W H J J C E B I Y P T C L S R V P B U
 S O C I A Y Y G S D Q S I F Y B S A L R S K B T J K K B R N
 S W T T U Q B H E L N E J T R N M M R T Y N B N L Q G E Q E
 R H F A C E F G M U I J P Y N H Z Z U T N B S E P Y P C I S
 V Q C A U H E A V E N M D E D E B B U C A Y Y H B C H H J B
 N I J L T U B L I F S G U T E B S T S M G Z J P N Z K M L T
 G L W B T Q P E Q T V O O W C L I S C N O A G E S A H B J I
 D H S Z D T P G H L H V L U G A S P E P G B A T L K C I V L
 P T Y E D H Y N N I U S O G S U Z A Q S U I K S P R O V R E
 K Y J Z I T F A Y Y G P U H Q V F Z N M E U S P H V V M R I
 S O T N Q Z O D M H U H I B U A Z F R L A E R N L Z N T K A
 P A N K C T E V A B A T P S R E D L E S I D B R Q Y J Q J K
 P V A O U R J D S O D W I R M E B V U E E K N A U E L V S Q
 R C S B J R W B V I D B B V I I D F K B Y G Y P I H D U F Y
 B A L H K W S G Y R W H R S J E K H B I A C N L C Z R G Q R
 O L P F S P S C L F T J W U Q S S N I R Q M M Y C C Z B V B
 S O U V M N I Z K U L Y G B L G B T F C A N Q M M S B D B T
 L Z T I J K A H W Y A K T H J J U E W S O Q P T R G Y O R P
 K J E S U S G K L B A S K U T P Y E L C Y R L F B I A N B K
 W M N O T B W K W D O P W Q W Z E M J S E U J H G F E Z I Z
 V F D N A C A R W F A G I T K F E J B G A M D D B L M F U O

- | | | | |
|---------|-----------------|---------|-----------|
| ANGEL | FAITH | POWER | STEPHEN |
| ASLEEP | FALSE WITNESSES | SAUL | STONED |
| CLOTHES | HEAVEN | SCRIBES | SYNAGOGUE |
| COUNCIL | HIGH PRIEST | SEIZED | WISDOM |
| ELDERS | JESUS | SIGNS | WITNESS |
| FACE | PEOPLE | SPIRIT | WONDERS |

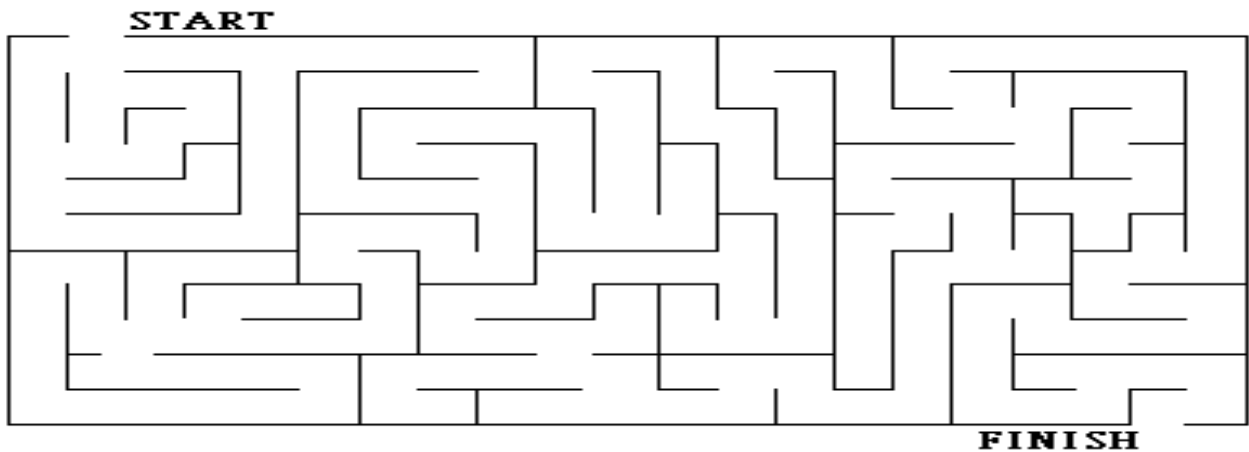

250. STEPHEN

(ACTS 6:2-8:2)

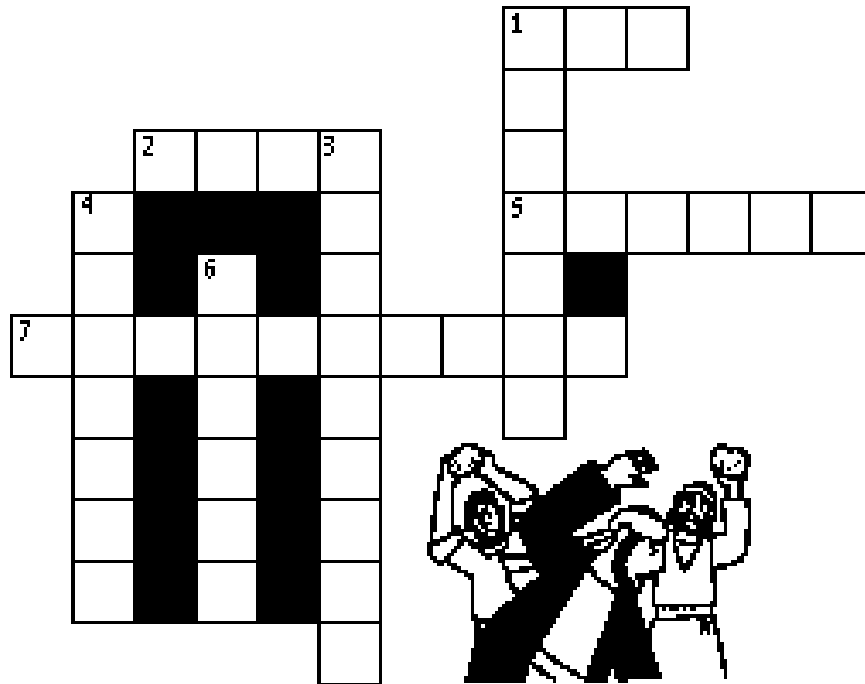

- 2 ACROSS "Then the twelve summoned the multitude of the disciples and said, 'It is not desirable that we should leave the _____ of God and serve tables.' " **ACTS 6:2**
- 5 ACROSS "Therefore, brethren, seek out from among you seven men of good reputation, full of the Holy Spirit and wisdom, whom we may appoint over this business; but we will give ourselves continually to _____ and to the ministry of the word." **ACTS 6:3-4**
- 7 ACROSS "And the word of God spread, and the number of the disciples _____ greatly in Jerusalem, and a great many of the priests were obedient to the faith." **ACTS 6:7**
- 1 DOWN "And _____, full of faith and power, did great wonders and signs among the people." **ACTS 6:8**
- 3 DOWN "Then there arose some from what is called the Synagogue of the Freedmen... _____ with Stephen." **ACTS 6:9**
- 4 DOWN "And they stirred up the people, the elders, and the scribes; and they came upon him, seized him, and brought him to the _____." **ACTS 6:12**
- 6 DOWN "Then they cried out with a loud voice, stopped their ears, and ran at him with one accord; and they cast him out of the city and _____ him." **ACTS 7:57-58**
- 1 ACROSS "And they stoned Stephen as he was calling on God and saying, 'Lord Jesus, receive my spirit.' Then he knelt down and cried out with a loud voice, 'Lord, do not charge them with this _____.' And when he had said this, he fell asleep." **ACTS 7:59-60**

Bible Story 251

**PHILIP
&
THE
ETHIOPIAN**

Acts 8:26-40

251. PHILIP AND THE ETHIOPIAN (ACTS 8:26-40)



"And when they were come up out of the water, the Spirit of the Lord caught away Philip, that the eunuch saw him no more: and he went on his way rejoicing."

ACTS 8:39

251. PHILIP AND THE ETHIOPIAN

(ACTS 8:26-40)

MEMORY VERSE:

"Now when they came up out of the water, the Spirit of the Lord caught Philip away, so that the eunuch saw him no more; and he went on his way rejoicing." ACTS 8:39

TRUE OR FALSE:

1. "Now an angel of the Lord spoke to Philip, saying, 'Arise and go toward the south along the road which goes down from Jerusalem to Gaza.' " **ACTS 8:26**

TRUE OR FALSE

CIRCLE THE CORRECT WORDS:

2. "So he arose and went. And behold, a man of (**EGYPT, ETHIOPIA**), a eunuch of great authority under Candace the queen of the (**EGYPTIANS, ETHIOPIANS**), who had charge of all her treasury, and had come to Jerusalem to worship." **ACTS 8:27**
3. "...And sitting in his chariot, he was reading (**ISAIAH, JONAH**) the prophet." **ACTS 8:28**

TRUE OR FALSE:

4. "Then the Spirit said to Philip, 'Go near and overtake this chariot.' " **ACTS 8:29**

TRUE OR FALSE

5. "So Philip ran to him, and heard him reading the prophet Isaiah, and said, 'Do you understand what you are reading?' " **ACTS 8:30**

TRUE OR FALSE

6. "And he said, 'How can I, unless someone guides me?' And he asked Philip to come up and sit with him." **ACTS 8:31**

TRUE OR FALSE

CIRCLE THE CORRECT WORDS:

7. "Then Philip opened his (**EAR, MOUTH**), and beginning at this Scripture, preached Jesus to him." **ACTS 8:35**
8. "Now as they went down the road, they came to some water. And the eunuch said, 'See, here is water. What hinders me from being baptized?' Then Philip said, 'If you believe with all your heart, you may.' And he answered and said, 'I (**BELIEVE, DON'T BELIEVE**) that Jesus Christ is the Son of God.'" **ACTS 8:36-37**
9. "Now when they came up out of the water, the Spirit of the Lord caught Philip away, so that the eunuch saw him no more; and he went on his way (**REJOICING, SAD**)." **ACTS 8:39**

251. PHILIP AND THE ETHIOPIAN

(ACTS 8:26-40)

P A N G E L G H W A T E R D I
H R O A D A C U B I J A U V Y
I K W D Z U M H A I A S I Z V
L T G A N G N I C I O J E R N
I O B U D S B Y F L B B T Y E
P I E P P N J O P A D C H O V
G R R T G R A E P V E Q I R E
N A U C U B E T S B Q K O C I
I H T P I Z I A S U W H P C L
D C P N D Z O L C R S C I U E
A G I B E Z L P T H E H A B B
E Z R D U E F Z S A E D N R W
R S C I K S W P A G D D N B E
Y B S V J G T I R I P S B U H
E E T G W Y U Z W O U L G P Z

ANGEL
BAPTIZED
BELIEVE
CHARIOT
ETHIOPIAN
EUNUCH
GAZA

GUIDE
ISAIAH
JESUS
PHILIP
PREACHED
READING

REJOICING
ROAD
SCRIPTURE
SPIRIT
UNDERSTAND
WATER

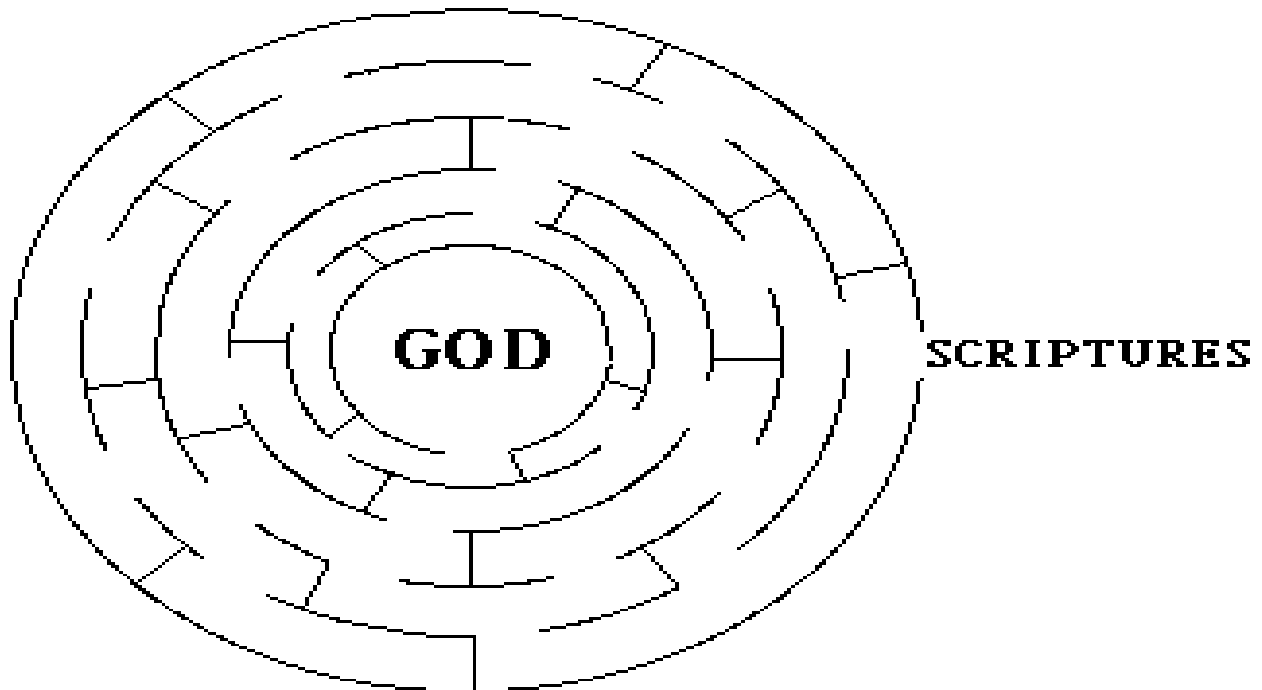

251. PHILIP AND THE ETHIOPIAN

(ACTS 8:26-40)

MEMORY VERSE:

"Now when they came up out of the water, the Spirit of the Lord caught Philip away, so that the eunuch saw him no more; and he went on his way rejoicing." ACTS 8:39

TRUE OR FALSE:

1. "Now an angel of the Lord spoke to Philip, saying, 'Arise and go toward the south along the road which goes down from Jerusalem to Gaza.'" **ACTS 8:26**

TRUE OR FALSE

FILL IN THE BLANKS:

2. "So he arose and went. And behold, a man of _____, a eunuch of _____ great authority under Candace the queen of the _____, who _____ had charge of all her treasury, and had come to Jerusalem to worship." **ACTS 8:27**

3. "...And sitting in his chariot, he was reading _____ the prophet." **ACTS 8:28**

TRUE OR FALSE:

4. "Then the Spirit said to Philip, 'Go near and overtake this chariot.'" **ACTS 8:29**

TRUE OR FALSE

5. "So Philip ran to him, and heard him reading the prophet Isaiah, and said, 'Do you understand what you are reading?'" **ACTS 8:30**

TRUE OR FALSE

6. "And he said, 'How can I, unless someone guides me?' And he asked Philip to come up and sit with him." **ACTS 8:31**

TRUE OR FALSE

FILL IN THE BLANKS:

7. "Then Philip opened his _____, and beginning at this Scripture, preached Jesus to him." **ACTS 8:35**

8. "Now as they went down the road, they came to some water. And the eunuch said, 'See, here is water. What hinders me from being baptized?' Then Philip said, 'If you believe with all your heart, you may.' And he answered and said, 'I _____ that Jesus Christ is the Son of God.'" **ACTS 8:36-37**

9. "Now when they came up out of the water, the Spirit of the Lord caught Philip away, so that the eunuch saw him no more; and he went on his way _____." **ACTS 8:39**

251. PHILIP AND THE ETHIOPIAN

(ACTS 8:26-40)

E D I U G F B I B D H Z L H E E U J L Y F M P V P
 Y D Z J L J U P V O K L G E J U K Z U B W U A B H
 U A B V N F L M B T W A E N L Z B T C D V Z V T Q
 W O C Q B E Y W H C Z B P P D B B T R Q B D T G O
 D R S D Z O L L C A W I K T Z E F I K N Q C P H Z
 O M L D S R H G O U B V S L P Q D E Z I T P A B F
 K G S D V I B E Y D L T N Z E A A J J N J A G Q L
 J G N V M Y K S V V N G I T B L Y I E B C B F Z Q
 Q T P V O S K Z K E N A U R L T B J S Y A B K T P
 B E M D N Y B R E I I V T T I B O P U V S L K W S
 Z L N K G D D O C N R L W S I P H I S Y B I O V B
 P S Q B I Y O I O V N T E B R I S B R B W H C B U
 Q V Q S C B O J J A Q L S B L E C B G A D V T W D
 L P H H N J F L I M C C R I A F D R W D H M N M Z
 A Z V P E O B P S U R E P H I H M N E F I C B V O
 L S Z R E J O L Z O A M C S R V U H U P A E U Z B
 L M U P B I Q A N D H U C M O E C B T N J Y Q Q U
 M B D R H C R G I B N G T H N A E R U T P I R C S
 S A F T P V K N W U N K P V E L A Q W I T Y D B O
 O K E B U G G H E M N M M R T C K K D A L S Y U B
 A I H N U W D G I G V P P Y V J I L C D T Q C W T
 L Y G G R H F N O I S A I A H I L E V L N E Z D L
 L E G N A H H W V Q G E S B B T O S S G J K R Y R
 K T U B J B L B M O R I D L K B Z Z U R O Y Y N F
 N F Q L Z B D W G T K P Q M C I I R K A I J S K F

ANGEL
 BAPTIZED
 BELIEVE
 CHARIOT
 ETHIOPIAN
 EUNUCH
 GAZA

GUIDE
 ISAIAH
 JESUS
 PHILIP
 PREACHED
 READING

REJOICING
 ROAD
 SCRIPTURE
 SPIRIT
 UNDERSTAND
 WATER



251. PHILIP AND THE ETHIOPIAN

(ACTS 8:26-40)

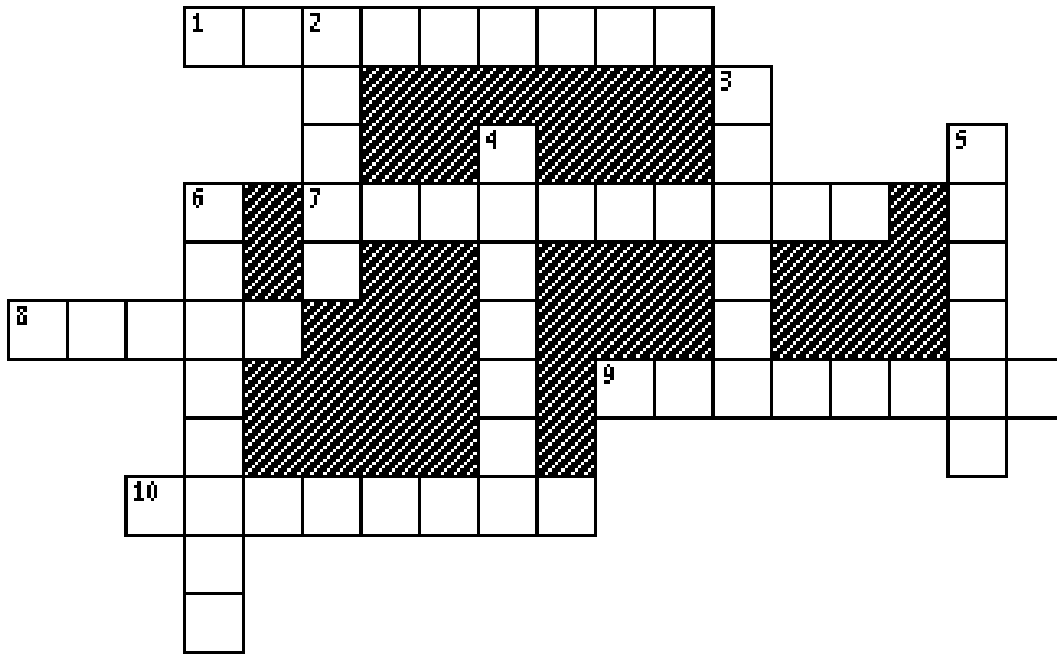

- 8 ACROSS "Now an ____ of the Lord spoke to Philip, saying, 'Arise and go toward the south along the road which goes down from Jerusalem to Gaza.' " **ACTS 8:26**
- 9 ACROSS "So he arose and went. And behold, a man of ____, a eunuch of great authority under Candace the queen of the Ethiopian, who had charge of all her treasury, and had come to Jerusalem to worship." **ACTS 8:27**
- 3 DOWN "...And sitting in his chariot, he was reading ____ the prophet." **ACTS 8:28**
- 6 DOWN "Then the Spirit said to Philip, 'Go near and ____ this chariot.' " **ACTS 8:29**
- 7 ACROSS "So Philip ran to him, and heard him reading the prophet Isaiah, and said, 'Do you ____ what you are reading?' " **ACTS 8:30**
- 5 DOWN "And he said, 'How can I, unless someone guides me?' And he asked ____ to come up and sit with him." **ACTS 8:31**
- 2 DOWN "Then Philip opened his mouth, and beginning at this Scripture, preached ____ to him." **ACTS 8:35**
- 10 ACROSS "Now as they went down the road, they came to some water. And the eunuch said, 'See, here is water. What hinders me from being ____?' " **ACTS 8:36**
- 4 DOWN "Then Philip said, 'If you ____ with all your heart, you may.' And he answered and said, 'I believe that Jesus Christ is the Son of God.' " **ACTS 8:37**
- 1 ACROSS "Now when they came up out of the water, the Spirit of the Lord caught Philip away, so that the eunuch saw him no more; and he went on his way ____." **ACTS 8:39**

Bible Story 252

SAUL IS CONVERTED

Acts 8:1-4; 9:1-22

252. SAUL IS CONVERTED

(ACTS 8:1-4, 9:1-22)



"And as he journeyed, he came near Damascus: and suddenly there shined round about him a light from heaven: And he fell to the earth, and heard a voice saying unto him, Saul, Saul, why persecutest thou me?"

ACTS 9:3-4

252. SAUL IS CONVERTED

(ACTS 8:1-4, 9:1-22)

MEMORY VERSE:

"But Saul increased all the more in strength, and confounded the Jews who dwelt in Damascus, proving that this Jesus is the Christ." ACTS 9:22

CIRCLE THE CORRECT WORD:

1. "...At that time a great persecution arose against the church which was at Jerusalem; and they were all scattered throughout the regions of Judea and Samaria, except the (PHARISEES, APOSTLES)." ACTS 8:1

TRUE OR FALSE:

2. "As for Saul, he made havoc of the church, entering every house, and dragging off men and women, committing them to prison." ACTS 8:3

TRUE OR FALSE

3. Therefore those who were scattered went everywhere hiding. ACTS 8:4

TRUE OR FALSE

CIRCLE THE CORRECT WORDS:

4. "And as he journeyed he came near Damascus, and suddenly a (LIGHT, RAINBOW) shone around him from heaven." ACTS 9:3

5. "Then he fell to the ground, and heard a voice saying to him, 'Saul, Saul, why are you (FOLLOWING, PERSECUTING) Me?' " ACTS 9:4

TRUE OR FALSE:

6. "So he, trembling and astonished, said, 'Lord, what do You want me to do?' And the Lord said to him, 'Arise and go into the city, and you will be told what you must do.' " ACTS 9:6

TRUE OR FALSE

CIRCLE THE CORRECT WORDS:

7. "Then Saul arose from the ground, and when his eyes were opened he saw no one. But they led him by the hand and brought him into Damascus. And he was three days (WITH, WITHOUT) sight, and neither ate nor drank." ACTS 9:8-9

TRUE OR FALSE:

8. "And Ananias went his way and entered the house; and laying his hands on him he said, 'Brother Saul, the Lord Jesus, who appeared to you on the road as you came, has sent me that you may receive your sight and be filled with the Holy Spirit.' " ACTS 9:17

TRUE OR FALSE

9. "But Saul increased all the more in strength, and confounded the Jews who dwelt in Damascus, proving that this Jesus is the Christ." ACTS 9:22

TRUE OR FALSE

252. SAUL IS CONVERTED

(ACTS 8:1-4, 9:1-22)

MEMORY VERSE:

"But Saul increased all the more in strength, and confounded the Jews who dwelt in Damascus, proving that this Jesus is the Christ." ACTS 9:22

FILL IN THE BLANK:

1. "...At that time a great persecution arose against the church which was at Jerusalem; and they were all scattered throughout the regions of Judea and Samaria, except the _____." **ACTS 8:1**

TRUE OR FALSE:

2. "As for Saul, he made havoc of the church, entering every house, and dragging off men and women, committing them to prison." **ACTS 8:3**

TRUE OR FALSE

3. Therefore those who were scattered went everywhere hiding. **ACTS 8:4**

TRUE OR FALSE

FILL IN THE BLANKS:

4. "And as he journeyed he came near Damascus, and suddenly a _____ shone around him from heaven." **ACTS 9:3**

5. "Then he fell to the ground, and heard a voice saying to him, 'Saul, Saul, why are you _____ Me?' " **ACTS 9:4**

TRUE OR FALSE:

6. "So he, trembling and astonished, said, 'Lord, what do You want me to do?' And the Lord said to him, 'Arise and go into the city, and you will be told what you must do.' " **ACTS 9:6**

TRUE OR FALSE

FILL IN THE BLANK:

7. "Then Saul arose from the ground, and when his eyes were opened he saw no one. But they led him by the hand and brought him into Damascus. And he was three days _____ sight, and neither ate nor drank." **ACTS 9:8-9**

TRUE OR FALSE:

8. "And Ananias went his way and entered the house; and laying his hands on him he said, 'Brother Saul, the Lord Jesus, who appeared to you on the road as you came, has sent me that you may receive your sight and be filled with the Holy Spirit.' " **ACTS 9:17**

TRUE OR FALSE

9. "But Saul increased all the more in strength, and confounded the Jews who dwelt in Damascus, proving that this Jesus is the Christ." **ACTS 9:22**

TRUE OR FALSE

252. SAUL IS CONVERTED

(ACTS 8:1-4; 9:1-22)

T G S M G V I A Z M D A S L J B Q N W W A W S A P
 B N D H Y G Q I U G S V E S S E L R A V Z G G R H
 L L G Y Q W S P U Q U S U D S K E G T H Y B E W L
 M W I Y D D S Q I W F P J N R L P I Z W E A Y I U
 E Y P N O K O F B G F W D K V D G K V S C T M L A
 Z Z C M D A E R Q B E J L E J O H F K H D D B V B
 I U G N I Y A R P W R H J A Z I G T E R A P O U G
 I G V B O G Z G B D I N T U G I S D B V M T L A D
 D F U P S S P C N I M F B H D C T S M B A C F G V
 Z Y I R E A N A N I A S P W A H L P S K S P W O Z
 P I P Y L A E G V C T R V L U Y Y T A G C N U J Y
 Z F N R P U U O B P I U E K V Q T O H B U B U S O
 V B S E I S V W W E O S C Y C K P Y J P S I U D R
 V L C B C A F J S L O G Q E G G V T L E N S Y E C
 U O N V S U I T Y O F I O Y S O E T B I E V O Q C
 D A I T I L U V U P U E V E O R N G B J V G L W U
 W E P C D K D H K D D G Y H Q J E F K N A U P D B
 E Z C O E E H Y Y Q I W B L A M J P N A E K Z U R
 E C B J Z S I G G N I R A E H N A I P V H J P A M
 B L C A K Y P M H J V K C B E R H Y F I K W Z B T
 D W M Q P B K T I R I P S Y L O H M H W G S B C H
 V A X L Z F R B F J E O J R G M N R J A Z F F Q E
 N C P P S L E U Q C M I N O A I Y A K M S Z P K W
 P A R D R O L V B B N L B W T F W U Z H B Z T H A
 Y Z E V T K N E H V B D L H N J C V W L E E S C Y

AMAZED
 ANANIAS
 BAPTIZED
 BLIND
 DAMASCUS
 DISCIPLES

HEARING
 HEAVEN
 HIGH PRIEST
 HOLY SPIRIT
 JESUS

LORD
 PERSECUTING
 PRAYING
 PREACHED
 SAUL

SCALES
 SUFFER
 THE WAY
 VESSEL
 VOICE

THE ROAD BEGINS HERE

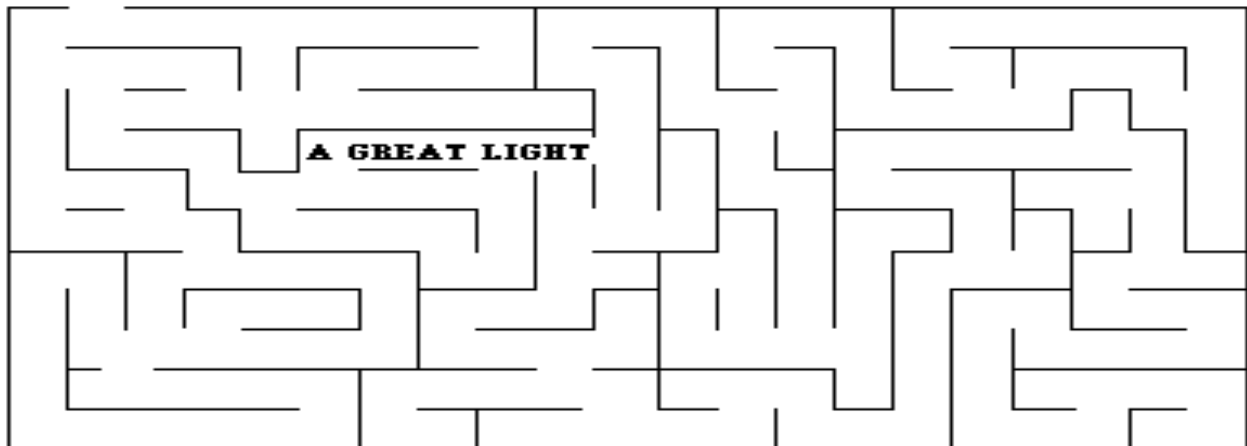

DAMASCUS

252. SAUL IS CONVERTED

(ACTS 8:1-4, 9:1-22)

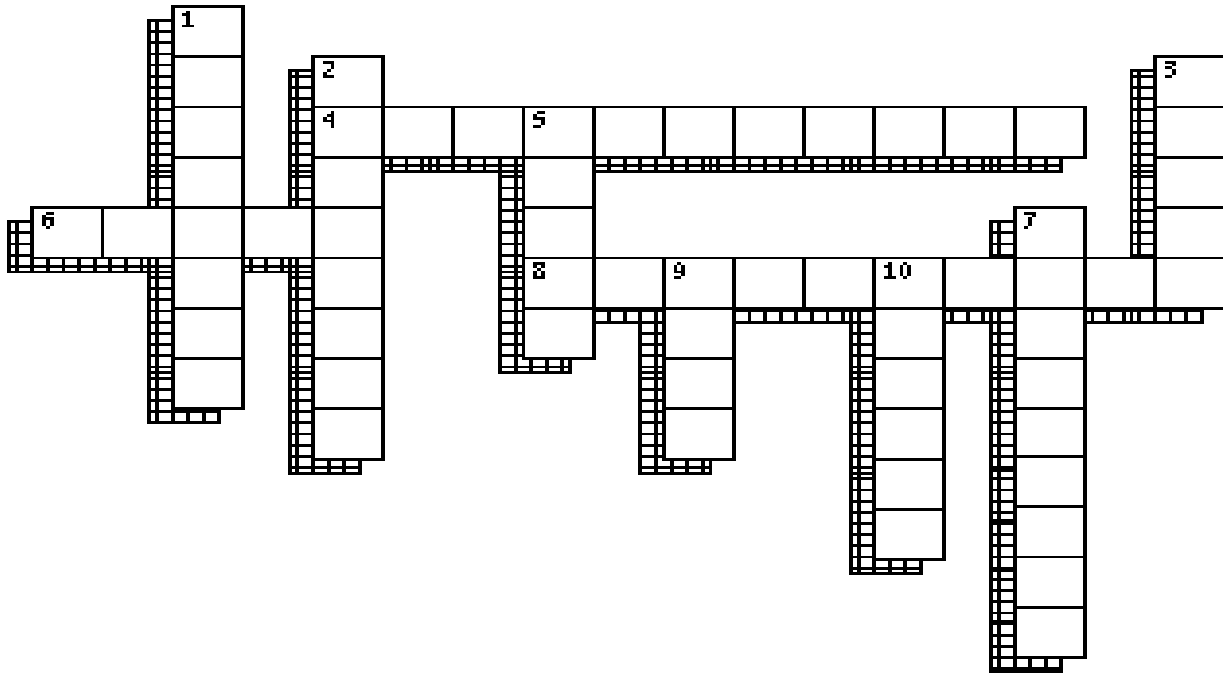

- 2 DOWN "...At that time a great persecution arose against the church which was at Jerusalem; and they were all scattered throughout the regions of Judea and Samaria, except the ____." **ACTS 8:1**
- 10 DOWN "As for Saul, he made havoc of the church, entering every house, and dragging off men and women, committing them to ____." **ACTS 8:3**
- 7 DOWN "Therefore those who were scattered went everywhere ____ the word." **ACTS 8:4**
- 3 DOWN "And as he journeyed he came near Damascus, and suddenly a ____ shone around him from heaven." **ACTS 9:3**
- 4 ACROSS "Then he fell to the ground, and heard a voice saying to him, 'Saul, Saul, why are you ____ Me?' " **ACTS 9:4**
- 9 DOWN "So he, trembling and astonished, said, '____, what do You want me to do?' And the Lord said to him, 'Arise and go into the city, and you will be told what you must do.'" **ACTS 9:6**
- 1 DOWN "Then Saul arose from the ground, and when his eyes were opened he saw no one. But they led him by the hand and brought him into ____." **ACTS 9:8**
- 5 DOWN "And he was three days without ____, and neither ate nor drank." **ACTS 9:9**
- 8 ACROSS "And Ananias went his way and entered the house; and laying his hands on him he said, 'Brother Saul, the Lord Jesus, who appeared to you on the road as you came, has sent me that you may receive your sight and be filled with the ____ ____.'" **ACTS 9:17**
- 6 ACROSS "But Saul increased all the more in strength, and confounded the Jews who dwelt in Damascus, proving that this ____ is the Christ." **ACTS 9:22**

Bible Story 253

PETER RAISES TABITHA

Acts 9:36-43

253. PETER RAISES TABITHA (ACTS 9:36-43)



"But Peter put them all forth, and kneeled down, and prayed; and turning *him* to the body said, Tabitha, arise. And she opened her eyes: and when she saw Peter, she sat up."

ACTS 9:40

253. PETER RAISES TABITHA

(ACTS 9:36-43)

MEMORY VERSE:

"Then he gave her his hand and lifted her up; and when he called the saints and widows, he presented her alive. And it became known throughout all Joppa, and many believed on the Lord." ACTS 9:41-42

UNDERLINE THE CORRECT ANSWERS:

1. "At Joppa, there was a certain disciple named Tabitha, which is translated Dorcas. This woman was _____." **ACTS 9:36**
 - a. very mean
 - b. full of good works and charitable deeds which she did

TRUE OR FALSE:

2. "But it happened in those days that she became sick and died..." **ACTS 9:37**
TRUE OR FALSE

CIRCLE THE CORRECT WORD:

3. "And since Lydda was near Joppa, and the disciples had heard that (**PETER, PAUL**) was there, they sent two men to him, imploring him not to delay in coming to them." **ACTS 9:38**

TRUE OR FALSE:

4. Then Peter arose but would not go with them... **ACTS 9:39**
TRUE OR FALSE

CIRCLE THE CORRECT WORDS:

5. "...they brought him to the upper room. And all the widows stood by him weeping, showing the (**TUNICS, TUNA**) and garments which Dorcas had made while she was with them." **ACTS 9:39**

6. "But Peter put them all out, and knelt down and (**CRIED, PRAYED**)..." **ACTS 9:40**

TRUE OR FALSE:

7. "...And turning to the body he said, 'Tabitha, arise.' And she opened her eyes, and when she saw Peter she sat up." **ACTS 9:40**
TRUE OR FALSE

8. "And it became known throughout all Joppa, and many believed on the Lord." **ACTS 9:42**
TRUE OR FALSE

253. PETER RAISES TABITHA

(ACTS 9:36-43)

U	L	I	D	E	E	D	S	S	I	C	K	B	H	V
V	D	F	E	A	N	T	A	B	I	T	H	A	J	B
C	O	J	R	N	Y	F	E	V	I	L	A	B	B	B
G	H	I	P	J	M	O	O	R	R	E	P	P	U	G
O	S	Q	G	E	G	A	R	M	E	N	T	S	Z	P
E	Y	S	B	E	L	I	E	V	E	D	M	D	W	E
Q	Q	K	G	P	W	B	T	J	A	A	S	I	W	I
A	K	R	L	E	C	T	A	F	O	T	H	E	V	A
E	G	O	Y	T	N	S	G	T	U	P	J	D	H	D
G	O	W	T	E	R	T	N	I	I	Z	P	N	W	D
A	J	D	P	R	G	O	O	D	O	R	C	A	S	Y
T	M	O	V	A	I	Y	M	Y	V	V	A	P	S	L
N	N	O	W	E	E	P	I	N	G	K	L	H	R	N
B	R	G	E	H	K	T	S	M	W	B	B	F	C	A
K	M	S	C	I	N	U	T	R	D	E	Y	A	R	P

ALIVE
ARISE
BELIEVED
CHARITABLE
DEEDS
DIED
DORCAS

GARMENTS
GOOD WORKS
JOPPA
LYDDA
PETER
PRAYED

SICK
SIMON
TABITHA
TUNICS
UPPER ROOM
WEEPING



253. PETER RAISES TABITHA (ACTS 9:36-43)

MEMORY VERSE:

"Then he gave her his hand and lifted her up; and when he called the saints and widows, he presented her alive. And it became known throughout all Joppa, and many believed on the Lord." ACTS 9:41-42

UNDERLINE THE CORRECT ANSWER:

1. "At Joppa, there was a certain disciple named Tabitha, which is translated Dorcas. This woman was _____." **ACTS 9:36**
- very mean
 - full of good works and charitable deeds which she did

TRUE OR FALSE:

2. "But it happened in those days that she became sick and died..." **ACTS 9:37**
TRUE OR FALSE

FILL IN THE BLANK:

3. "And since Lydda was near Joppa, and the disciples had heard that _____ was there, they sent two men to him, imploring him not to delay in coming to them." **ACTS 9:38**

TRUE OR FALSE:

4. Then Peter arose but would not go with them... **ACTS 9:39**
TRUE OR FALSE

FILL IN THE BLANKS:

5. "...they brought him to the upper room. And all the widows stood by him weeping, showing the _____ and garments which Dorcas had made while she was with them." **ACTS 9:39**
6. "But Peter put them all out, and knelt down and _____..." **ACTS 9:40**
7. "...And turning to the body he said, 'Tabitha, arise.' And she _____ her eyes, and when she saw Peter she sat up." **ACTS 9:40**

TRUE OR FALSE:

8. "And it became known throughout all Joppa, and many believed on the Lord." **ACTS 9:42**
TRUE OR FALSE

253. PETER RAISES TABITHA (ACTS 9:36-43)

Z Y L S D E E D E L B A T I R A H C U W
 O D R Z A S T M V G T V K M S A Q X H Z
 V H Z N W B K F B S N Y J T L B Q V Y F
 L I P O C B C R I I S I N D D Y F E J O
 C I D W H C V I O S A E P E K Z E H A J
 E A P M H B S E F W M H Y E V R Z C L L
 G L E O O Z H V B R D E T I E I H K C N
 V N T O F A D M A B Y O J I G W L Z Q A
 T F E R B K L G L W T O O R B Q F A Y Y
 Y R R R D I H N Y J P Z E G C A K M V O
 E D H E O L Z I E P G V Z G A V T C F P
 R K M P R U E M A F E P Y K B D M J I B
 B S Y P C H S J Q I R A R F B E D A D S
 W F U U A B Q C L K R A R I S E C Y Q E
 I B B B S P U E T G K U B Q V Y G P L A
 S I M O N P B W B A U D I E D B J N D Q
 B Y S I X Y Z D E Y A R P N K P O E I T
 U D S T U N I C S Z P Y I I G B X P D S
 W C V Z Z J F G B I S E D G V N F X B C
 N P Y A G V N G K N Q D A J E Y O U V T

- | | | |
|------------------|------------|------------|
| ALIVE | GARMENTS | SICK |
| ARISE | GOOD WORKS | SIMON |
| BELIEVE | JOPPA | TABITHA |
| CHARITABLE DEEDS | LYDDA | TUNICS |
| DIED | PETER | UPPER ROOM |
| DORCAS | PRAYED | WEEPING |

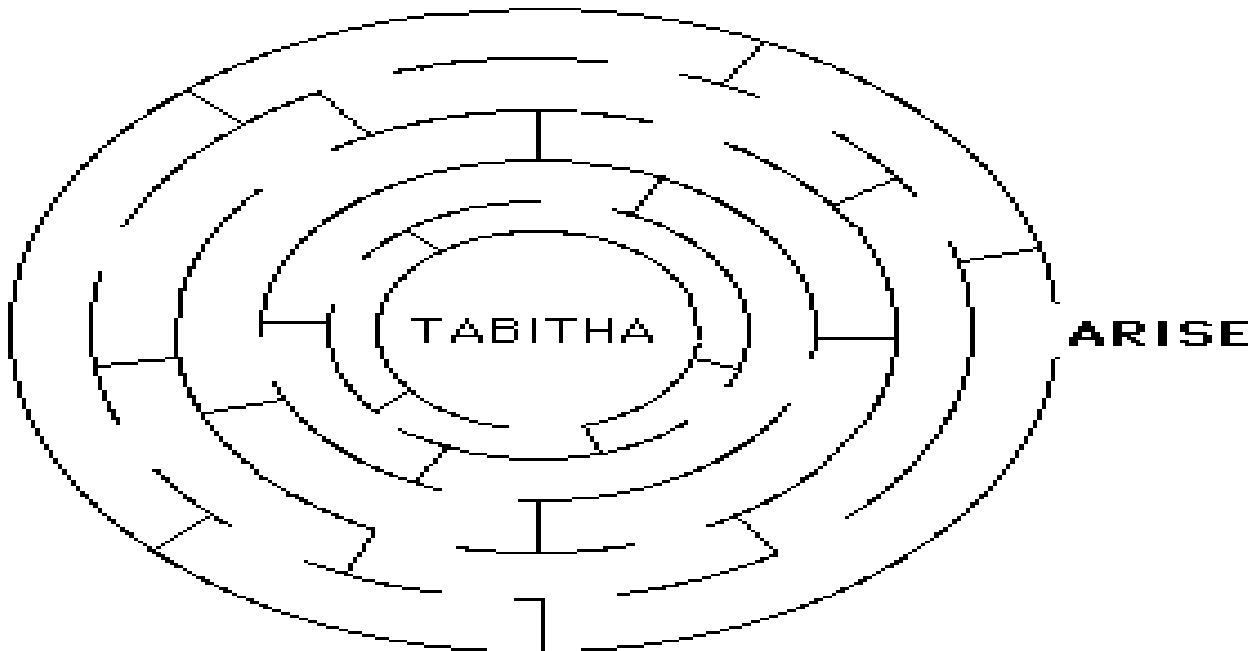

253. PETER RAISES TABITHA

(ACTS 9:36-43)

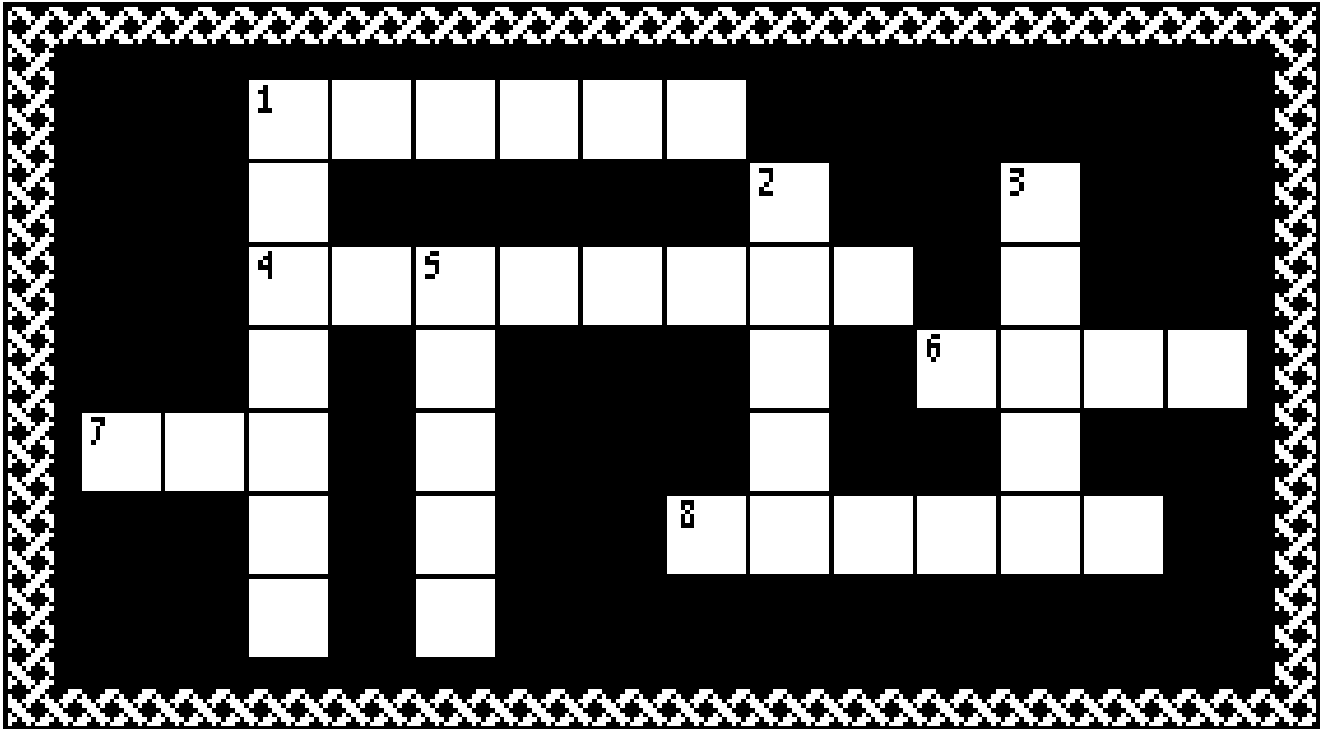

- 1 DOWN "At Joppa, there was a certain disciple named _____, which is translated Dorcas. This woman was full of good works and charitable deeds which she did." **ACTS 9:36**
- 6 ACROSS "But it happened in those days that she became sick and _____." **ACTS 9:37**
- 5 DOWN "And since _____ was near Joppa, and the disciples had heard that Peter was there, they sent two men to him, imploring him not to delay in coming to them." **ACTS 9:38**
- 2 DOWN "Then _____ arose and went with them..." **ACTS 9:39**
- 1 ACROSS "...they brought him to the upper room. And all the widows stood by him weeping, showing the _____ and garments which Dorcas had made while she was with them." **ACTS 9:39**
- 8 ACROSS "But Peter put them all out, and knelt down and _____." **ACTS 9:40**
- 7 ACROSS "...And turning to the body he said, 'Tabitha, arise.' And she opened her eyes, and when she saw Peter she _____ up." **ACTS 9:40**
- 3 DOWN "Then he gave her his hand and lifted her up; and when he called the saints and widows, he presented her _____." **ACTS 9:41**
- 4 ACROSS "And it became known throughout all Joppa, and many _____ on the Lord." **ACTS 9:42**

Bible Story 254

**PETER
& CORNELIUS**

Acts 10:1-8, 24-48

254. PETER AND CORNELIUS

(ACTS 10:1-8, 24-48)



"He saw in a vision evidently about the ninth hour of the day an angel of God coming in to him, and saying unto him, Cornelius. And when he looked on him, he was afraid, and said, What is it, Lord? And he said unto him, Thy prayers and thine alms are come up for a memorial before God."

ACTS 10:3-4

254. PETER AND CORNELIUS

(ACTS 10:1-8, 24-48)

MEMORY VERSE:

"To Him all the prophets witness that, through His name, whoever believes in Him will receive remission of sins." ACTS 10:43

TRUE OR FALSE:

1. "There was a certain man in Caesarea called Cornelius, a centurion of what was called the Italian Regiment..." ACTS 10:1

TRUE OR FALSE

2. "...a devout man and one who feared God with all his household, who gave alms generously to the people, and prayed to God always." ACTS 10:2

TRUE OR FALSE

CIRCLE THE CORRECT WORD:

3. "About the ninth hour of the day he saw clearly in a (**CHARIOT**, **VISION**) an angel of God coming in and saying to him, 'Cornelius!' " ACTS 10:3

TRUE OR FALSE:

4. "And when he observed him, he was afraid, and said 'What is it lord?' So he said to him, 'Your prayers and your alms have come up for a memorial before God. Now send men to Joppa, and send for Simon whose surname is Peter.'" ACTS 10:4-5

TRUE OR FALSE

CIRCLE THE CORRECT WORDS:

5. "And the following day they entered (**CAESAREA**, **CAPERNAUM**). Now Cornelius was waiting _____ for them, and had called together his relatives and close friends." ACTS 10:24

6. "Then Peter opened his mouth and said: 'In truth I perceive that God shows no partiality. But in every nation whoever fears Him and works righteousness is (**ACCEPTED**, **REJECTED**) by Him.'" ACTS 10:34-35

7. "While Peter was still speaking these words, the (**ROOF**, **HOLY SPIRIT**) fell upon all those who heard the word." ACTS 10:44

TRUE OR FALSE:

8. "And he commanded them to be baptized in the name of the Lord..." ACTS 10:48

TRUE OR FALSE

254. PETER AND CORNELIUS

(ACTS 10:1-8, 24-48)

D D S M E M A X H U D G P D T K V J M N
 R E S J N A K O T A Y O G U B J S H J H
 R W V K C S T I L J E S U S C H R I S T
 W K S O S V U I U D S V K O W F U T Q B
 A I I E U I N R R D G E N E R O U S L A
 N E A G V T M N O I R U T N E C B J J U
 G P G H V I U O W W P S G L I Y H Y T V
 E I W G C Y T F N T M S P O U A L M S A
 L Y A D C K D A R T U P Y U M T U R W E
 H B F V F A L Y L E H T D L D R O W K I
 S C B B C A E B Q E T E S E O W Q D M S
 I B O G H W S S N L R E T I Z H T C L G
 W P A R R L U T A A B W P A D I P G U J
 E P P C N W F D I R S B O N N E T S G P
 J Y P Z E E L F I N E H T I O N Y P C Z
 P F O H M G L B S O G A W B O M E A A F
 N O J K Q W O I V A E J I M F U I R R B
 K J T K N Z Y D U P J Y M R O G L S V P
 B G E N T I L E S S M O H W E H J Q U B
 C W O R Y O H E U A C K J G P B B U B B

ALMS
 ANGEL
 BAPTIZED
 CAESAREA
 CENTURION
 COMMON

CORNELIUS
 DEVOUT
 FASTING
 GENEROUS
 GENTILES

GOD
 HOLY SPIRIT
 JESUS CHRIST
 JEWISH
 JOPPA

PRAYED
 RELATIVES
 SIMON PETER
 SIMON THE TANNER
 WORD

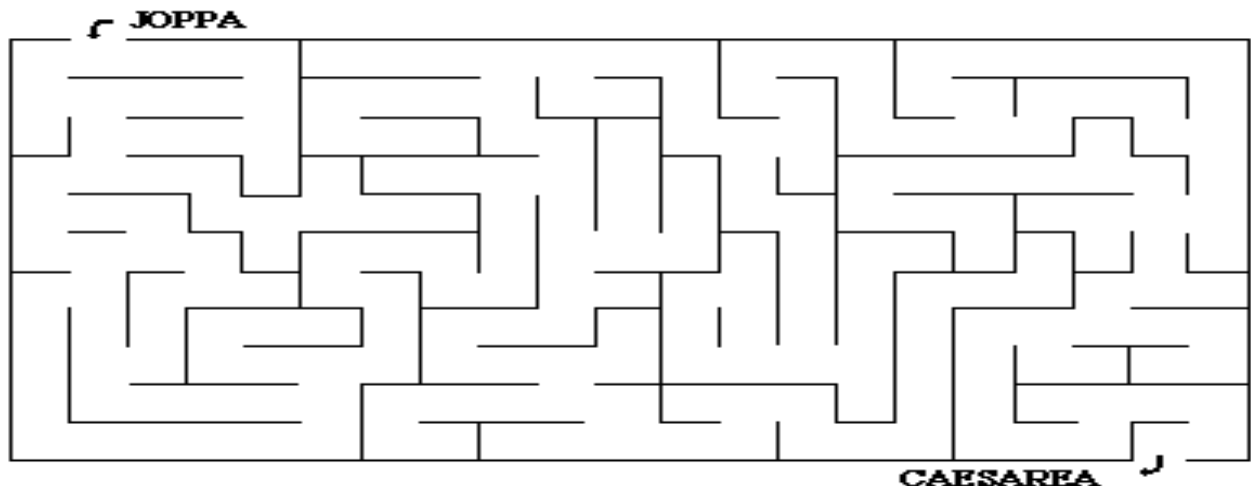

254. PETER AND CORNELIUS

(ACTS 10:1-8, 24-48)

MEMORY VERSE:

"To Him all the prophets witness that, through His name, whoever believes in Him will receive remission of sins." ACTS 10:43

TRUE OR FALSE:

1. "There was a certain man in Caesarea called Cornelius, a centurion of what was called the Italian Regiment..." **ACTS 10:1**
TRUE OR FALSE
2. "...a devout man and one who feared God with all his household, who gave alms generously to the people, and prayed to God always." **ACTS 10:2**
TRUE OR FALSE

FILL IN THE BLANK:

3. "About the ninth hour of the day he saw clearly in a _____ an angel of God coming in and saying to him, 'Cornelius!'" **ACTS 10:3**

TRUE OR FALSE:

4. "And when he observed him, he was afraid, and said 'What is it lord?' So he said to him, 'Your prayers and your alms have come up for a memorial before God. Now send men to Joppa, and send for Simon whose surname is Peter.'" **ACTS 10:4-5**
TRUE OR FALSE

FILL IN THE BLANKS:

5. "And the following day they entered _____. Now Cornelius was waiting for them, and had called together his relatives and close friends." **ACTS 10:24**
6. "Then Peter opened his mouth and said: 'In truth I perceive that God shows no partiality. But in every nation whoever fears Him and works righteousness is _____ by Him.'" **ACTS 10:34-35**
7. "While Peter was still speaking these words, the _____ _____ fell upon all those who heard the word." **ACTS 10:44**

TRUE OR FALSE:

8. "And he commanded them to be baptized in the name of the Lord..." **ACTS 10:48**
TRUE OR FALSE

254. PETER AND CORNELIUS

(ACTS 10:1-8, 24-48)

D E Y A R P L O U N J E W I S H I K Y A A P T K R
 N T L J W Q L J O N M P M A L A J G B S B G G P S
 P U L Z H R A S B V P M H I B Y I W F B F F H H M
 M O N F H K G Z M G E S V R F B J T P W L K Q Q L
 N V B J B D H N G R I D Y O H C B D N D I K Z O A
 Q E Z F B F G W Q K P Q X N V M N O I R U T N E C
 Q D S E B H N S O R L S L T E U B C I I H O T Z F
 H V V O U L W I E Z E T E V L A R V D A V C W F F
 V V M R L D B O T V S N M L C S B S L J M T V L Z
 A P P O J I W V H I I H N B I K U U G T E N B Q R
 Z D O I Y P B M R L E T E A J T Q I R L Y B W P F
 U K N Y A M V H K B R E A K T I N G L N Y U M S M
 D B G S L N C G W E C N J L I E K E O E S Q V B C
 F S I Y H S G D T I P O B H E L H K G D N D Z U R
 H H C D U W B E W V K A M S O R L T T J Q R Q D I
 G P N S B L P O L V P P U M T L E Y N O K Y O Z P
 U P E Y K N H T B T S O L C O O Y F A O N C B C Z
 Q J E B O G C C I T R T D E B N S S F O M G U O V
 J R B M K S O Z L E N L Z U I Z Z D P I Y I U B Q
 V B I O B Z E U N L U Z P Z U I R Q W I J Z S E Q
 Q S P J D D Y E R C W T E B K J L N V M R Y W U S
 D N U C O R G V Q C A E S A R E A N B U P I D O U
 G N I T S A F N C M S T B E B Z U F Q Z A S T X S
 D G U V F O K V R G C B L Q B T C Y J D V V Y T D
 D B R G B J E M H K T S I A F T R V C C T B N L E

ALMS
 ANGEL
 BAPTIZED
 CAESAREA
 CENTURION
 COMMON

CORNELIUS
 DEVOUT
 FASTING
 GENEROUS
 GENTILES

GOD
 HOLY SPIRIT
 JESUS CHRIST
 JEWISH
 JOPPA

PRAYED
 RELATIVES
 SIMON PETER
 SIMON THE TANNER
 TONGUES

JOPPA

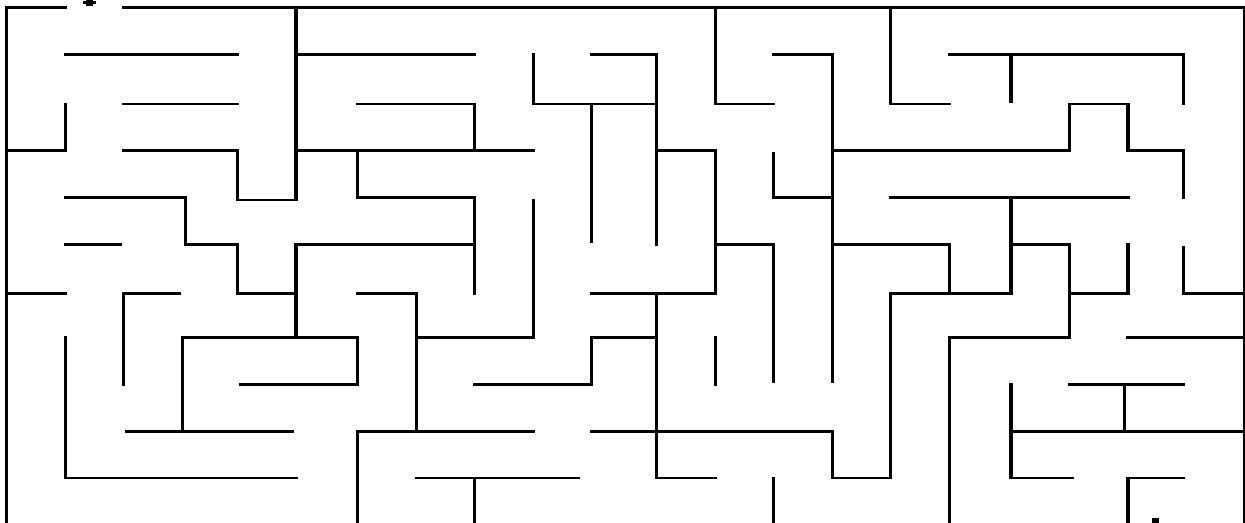

CAESAREA

254. PETER AND CORNELIUS

(ACTS 10:1-8, 24-48)

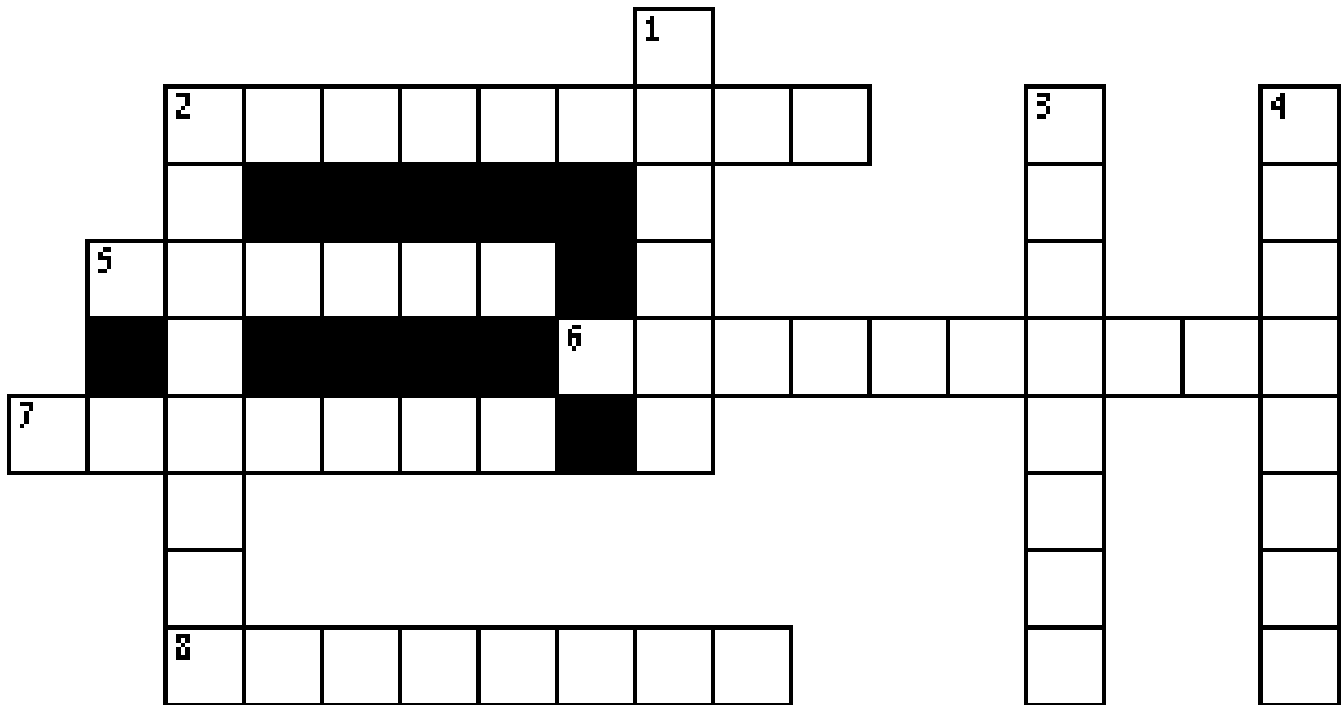

- 2 ACROSS "There was a certain man in Caesarea called Cornelius, a _____ of what was called the Italian Regiment..." **ACTS 10:1**
- 5 ACROSS "...a _____ man and one who feared God with all his household, who gave alms generously to the people, and prayed to God always." **ACTS 10:2**
- 1 DOWN "About the ninth hour of the day he saw clearly in a _____ an angel of God coming in and saying to him, 'Cornelius!' " **ACTS 10:3**
- 7 ACROSS "And when he observed him, he was afraid, and said 'What is it lord?' So he said to him, 'Your _____ and your alms have come up for a memorial before God. Now send men to Joppa, and send for Simon whose surname is Peter.' " **ACTS 10:4-5**
- 2 DOWN "And the following day they entered _____. Now Cornelius was waiting for them, and had called together his relatives and close friends." **ACTS 10:24**
- 8 ACROSS "Then Peter opened his mouth and said: 'In truth I perceive that God shows no partiality. But in every nation whoever fears Him and works righteousness is _____ by Him.'" **ACTS 10:34-35**
- 6 ACROSS "While Peter was still speaking these words, the _____ _____ fell upon all those who heard the word." **ACTS 10:44**
- 3 DOWN "To Him all the prophets witness that, through His name, whoever _____ in Him will receive remission of sins." **ACTS 10:43**
- 4 DOWN "And he commanded them to be _____ in the name of the Lord..." **ACTS 10:48**

Bible Story 255

PETER'S VISION

Acts 10:9-16

255. PETER'S VISION (ACTS 10:9-16)



"And saw heaven opened, and a certain vessel descending unto him,
as it had been a great sheet knit at the four corners, and let down to the earth:"

ACTS 10:11

255. PETER'S VISION

(ACTS 10:9-16)

MEMORY VERSE:

"...*What God has cleansed you must not call common.*" ACTS 10:15

FILL IN THE BLANK:

1. "The next day, as they went on their journey and drew near to the city, Peter went up on the housetop to _____, about the sixth hour." **ACTS 10:9**

TRUE OR FALSE:

2. "Then he became very hungry and wanted to eat; but while they made ready, he fell into a trance and saw an object like a great sheet bound at the four corners, descending to him and let down to the earth." **ACTS 10:10-11**

TRUE OR FALSE

UNDERLINE THE CORRECT ANSWER:

3. "In it were..." **ACTS 10:12**
- a. all kinds of four-footed animals of the earth
 - b. wild beasts
 - c. creeping things
 - d. birds of the air
 - e. all of the above

TRUE OR FALSE:

4. "And a voice came to Peter saying, 'Rise, Peter; kill and eat.' But Peter said, 'Not so, Lord! For I have never eaten anything common or unclean.'" **ACTS 10:13-14**

TRUE OR FALSE

CIRCLE THE CORRECT WORD:

5. "And a voice spoke to him again the second time, 'What (**GOD, MAN**) has cleansed you must not call common.'" **ACTS 10:15**

TRUE OR FALSE:

6. This was done two times... **ACTS 10:16**

TRUE OR FALSE

7. "...And the object was taken up into heaven again." **ACTS 10:16**

TRUE OR FALSE

255. PETER'S VISION

(ACTS 10:9-16)

B E A S T S D H Y P A K Q C K
K C P V D J T E E H S E R V I
G D L B N O C T Y K V E A T L
W Q N E I O E C S Y E O D T L
T N I Q A R I V O P T C Y S B
D N D J A N A S I R P T L G W
H E A V E N S N I J N A C H M
C Y L C J I G E Q V M E Z Q V
V F A A T T B M D I G N R Z Z
S Y G R H M F E N P F B Y S Q
B V R I P U L A U N C L E A N
K Y N T H R E E T I M E S I R
Y G A S L Z I S D R I B S T B
S B F B A S L E E P K U V W U
F F W W N H O U S E T O P V W

ANIMALS
ASLEEP
BEASTS
BIRDS
CLEANSED
CORNERS

CREEPING THINGS
EAT
HEAVEN
HOUSETOP
KILL
PETER

PRAY
RISE
SHEET
THREE TIMES
UNCLEAN
VISION

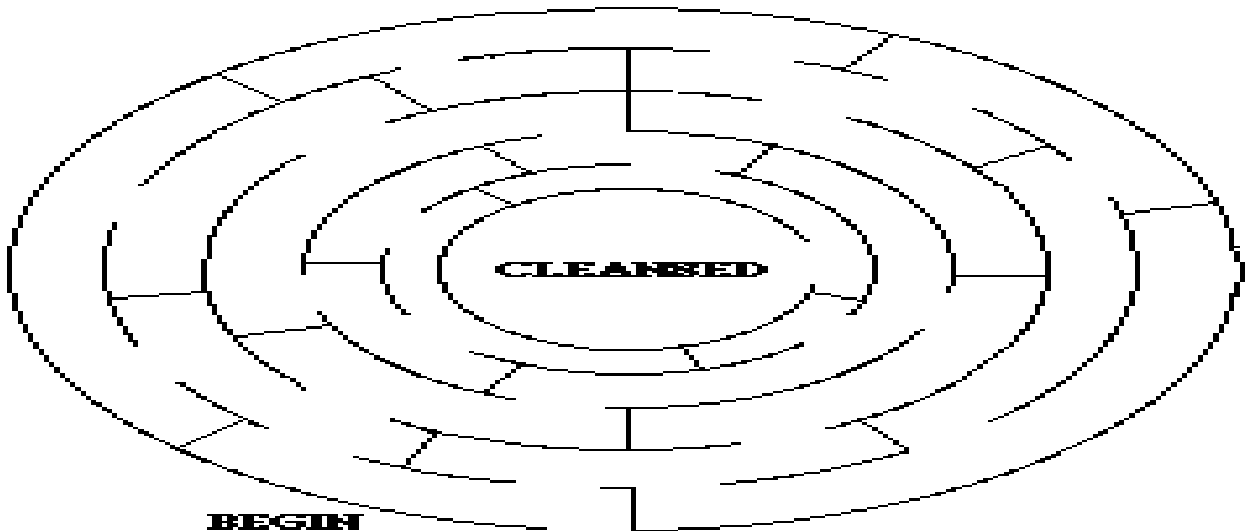

255. PETER'S VISION (ACTS 10:9-16)

MEMORY VERSE:

"...What God has cleansed you must not call common." ACTS 10:15

FILL IN THE BLANKS:

1. "The next day, as they went on their journey and drew near to the city, Peter went up on the housetop to _____, about the sixth hour." **ACTS 10:9**
2. "Then he became very hungry and wanted to eat; but while they made ready, he fell into a trance and saw an object like a great _____ bound at the four corners, descending to him and let down to the earth." **ACTS 10:10-11**

UNDERLINE THE CORRECT ANSWER:

3. "In it were..." **ACTS 10:12**
 - a. all kinds of four-footed animals of the earth
 - b. wild beasts
 - c. creeping things
 - d. birds of the air
 - e. all of the above

TRUE OR FALSE:

4. "And a voice came to Peter saying, 'Rise, Peter; kill and eat.' But Peter said, 'Not so, Lord! For I have never eaten anything common or unclean.'" **ACTS 10:13-14**
TRUE OR FALSE

FILL IN THE BLANK:

5. "And a voice spoke to him again the second time, 'What _____ has cleansed you must not call common.'" **ACTS 10:15**

TRUE OR FALSE:

6. This was done two times... **ACTS 10:16**
TRUE OR FALSE
7. "...And the object was taken up into heaven again." **ACTS 10:16**
TRUE OR FALSE

255. PETER'S VISION

(ACTS 10:9-16)

Y B E B S E M I T E E R H T Z D A S F H A C B K U
 V B R Y W B P D X R Z M E Q M Q Q Q N A J S C I O
 Z H B D K B Y I E R Y E B Q J D T E A G L O V Z B
 Y Z W C I Z J E B S H D B F A I V U B A L Y C U Z
 U Y I P Z G V V K S N I V E P A S R M K T Y A W S
 V Q B L A F T M S K R A K Z E D C I E S A C W A E
 M P U R A B C N I U E R E H N B N G G U E Y Z T J
 Y V W Z S C V I S A B G G L E A T L G L L D Z C M
 A M N P T B S M T P I R V H C V B Y H M B W E O B
 J V Y D S Z H J B S C I E F P H O U S E T O P B T
 R O D H A A D C W Q R S A M B W H F B O D S T U B
 O T H M E P L W J V E E B C U S G V Y T M A Q M K
 M J I Y B E H G F Y E K Y G D Z A B I J M B H P Q
 Q Z I U D T Z G K E P F Z R U F K O B S M T D A A
 D O A K L E E V G Z I Q I J H O E W A B I Q D J Q
 T V L S I R S B A P N B R O Y J N B P H B O S Y T
 O L N S W K Q I Z A G N Q B P R A Y E Z O T N K V
 N A E L C N U B I C T I V F J L C C U J R I F Q I
 U C F V W I U B O U H G E O A N B W R L H B N K J
 K I L L C L Z R N Y I J Y B L A C A B L P A V Y I
 C E R Y H U N L T E N L B V C Y C V M B N C W O Z
 H G D Z H E F Y S D G D P E Q O T W K Y T D T O V
 E V K N R H N E Y K S K B H Y P B P E E L S A Y L
 Q T S S O B M Q T J D G N C V B W B N C Y N U D G
 J Y F O F P F T G Y A C Y K B E R P B Z L V R Y N

ANIMALS
 ASLEEP
 BIRDS
 CLEANSED
 CORNERS
 CREEPING THINGS

EAT
 HEAVEN
 HOUSETOP
 KILL
 PETER
 PRAY

RISE
 SHEET
 THREE TIMES
 UNCLEAN
 VISION
 WILD BEASTS

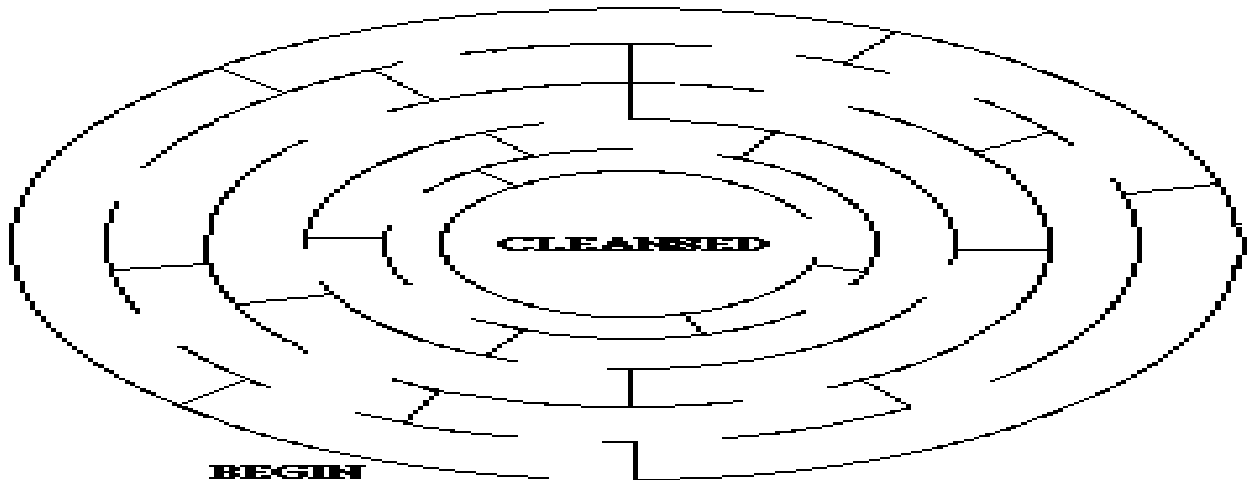

255. PETER'S VISION (ACTS 10:9-16)

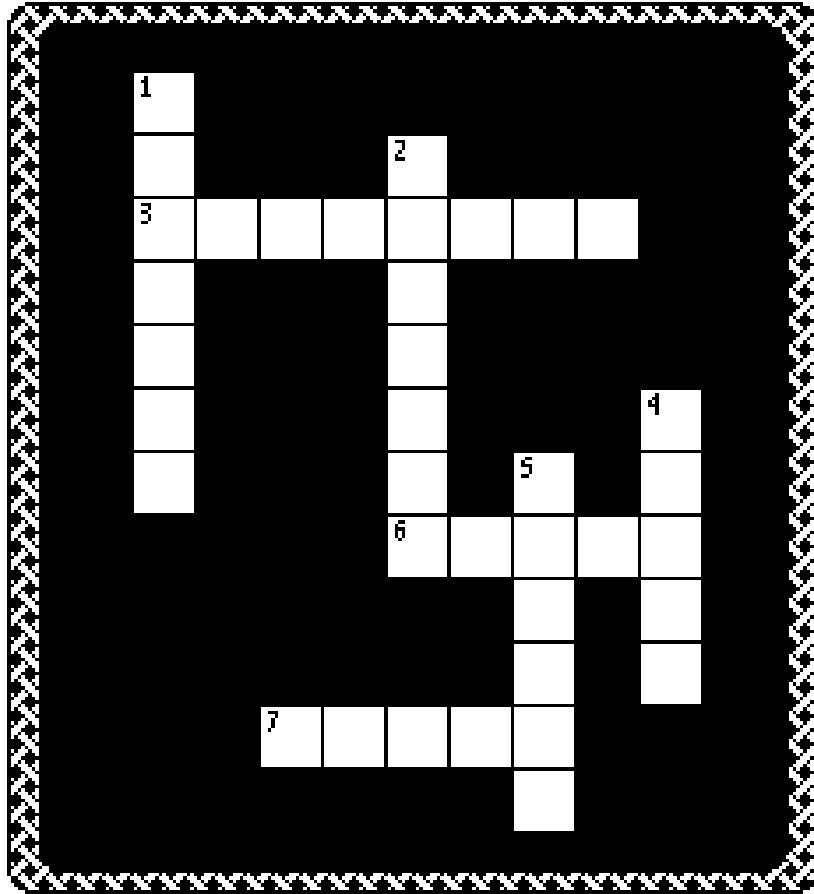

- 4 DOWN "The next day, as they went on their journey and drew near to the city, _____ went up on the housetop to pray, about the sixth hour." **ACTS 10:9**
- 6 ACROSS "Then he became very hungry and wanted to eat; but while they made ready, he fell into a trance and saw an object like a great _____ bound at the four corners, descending to him and let down to the earth." **ACTS 10:10-11**
- 2 DOWN "In it were all kinds of four-footed _____ of the earth, wild beasts, creeping things, and birds of the air." **ACTS 10:12**
- 1 DOWN "And a voice came to Peter saying, 'Rise, Peter; kill and eat.' But Peter said, 'Not so, Lord! For I have never eaten anything common or _____.'" **ACTS 10:13-14**
- 3 ACROSS "And a voice spoke to him again the second time, 'What God has _____ you must not call common.'" **ACTS 10:15**
- 7 ACROSS "This was done _____ times..." **ACTS 10:16**
- 5 DOWN "...And the object was taken up into _____ again." **ACTS 10:16**

Bible Story 256

**THE
CHURCH
IN ANTIOCH**

Acts 11:19-30

256. THE CHURCH IN ANTIOCH (ACTS 11:19-30)

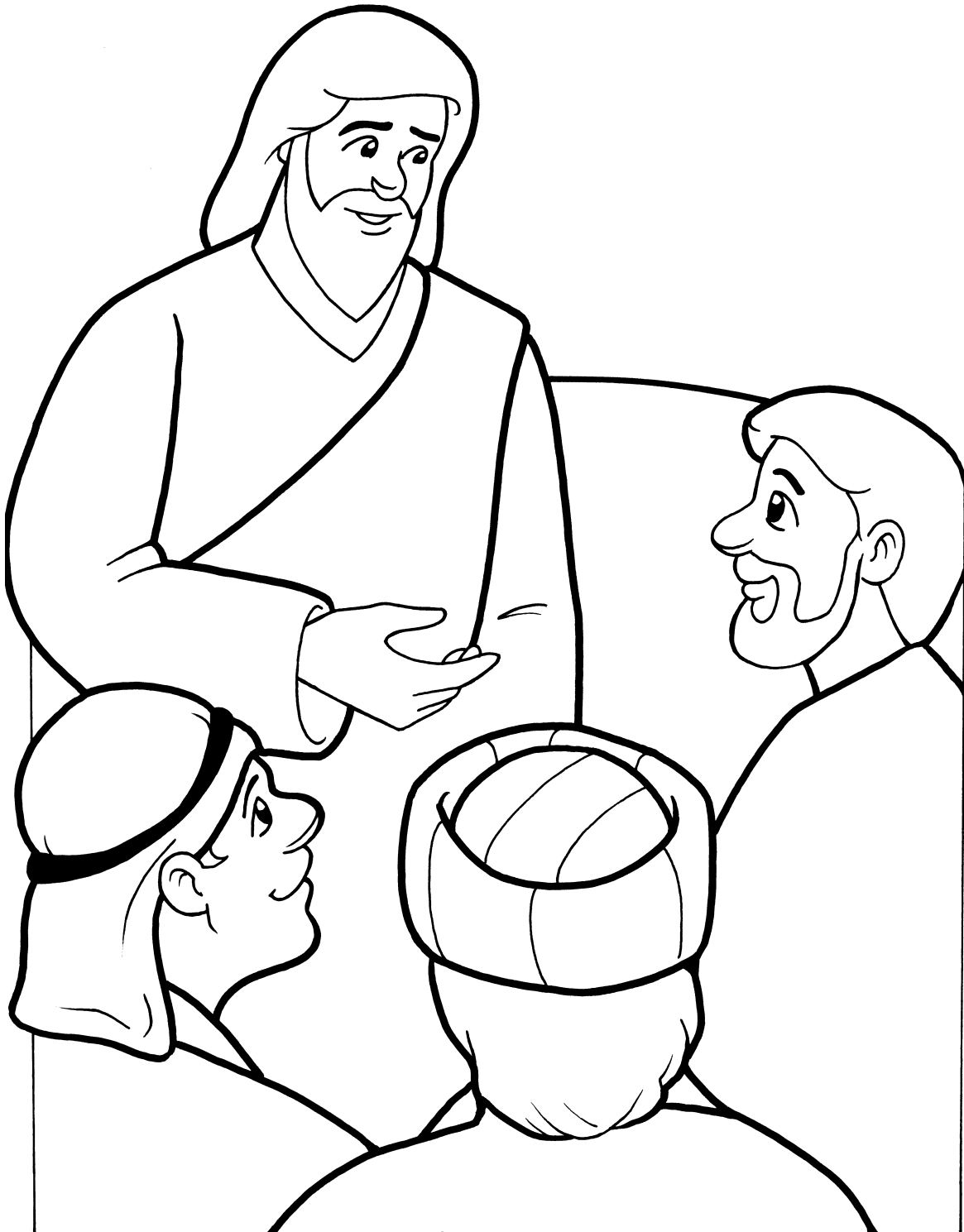

"Then departed Barnabas to Tarsus, for to seek Saul: And when he had found him, he brought him unto Antioch. And it came to pass, that a whole year they assembled themselves with the church, and taught much people. And the disciples were called Christians first in Antioch." **ACTS 11:25-26**

256. THE CHURCH IN ANTIOCH

(ACTS 11:19-30)

MEMORY VERSE:

"And the hand of the Lord was with them, and a great number believed and turned to the Lord." ACTS 11:21

CIRCLE THE CORRECT WORD:

1. "Now those who were (**SCATTERED, GATHERED**) after the persecution that arose over Stephen traveled as far as Phoenicia, Cyprus, and Antioch, preaching the word to no one but the Jews only." **ACTS 11:19**

FILL IN THE BLANKS:

2. "But some of them were men from Cyprus and Cyrene, who, when they had come to Antioch, spoke to the Hellenists, preaching the _____." **ACTS 11:20**

TRUE OR FALSE:

3. "And the hand of the Lord was with them, and a great number believed and turned to the Lord." **ACTS 11:21**

TRUE OR FALSE

CIRCLE THE CORRECT WORDS:

4. "Then news of these things came to the ears of the church in Jerusalem, and they sent out (**BARNABAS, SIMON**) to go as far as Antioch." **ACTS 11:22**
5. "When he came and had seen the (**TEMPLE, GRACE**) of God, he was glad, and encouraged them all that with purpose of heart they should continue with the Lord." **ACTS 11:23**
6. "Then Barnabas departed for Tarsus to seek Saul. And when he had found him, he brought him to (**ANTIOCH, HEBRON**). So it was that for a whole year they assembled with the church and taught a great many people..." **ACTS 11:25-26**

TRUE OR FALSE:

7. "...And the disciples were first called Christians in Antioch." **ACTS 11:25-26**

TRUE OR FALSE

256. THE CHURCH IN ANTIOCH

(ACTS 11:19-30)

D R E L I E F S A B A N R A B
 I A D D E D L O R D J E S U S
 S G R P Q Z O H C O I T N A M
 C F N I B T I R I P S Y L O H
 I D A Y N H E L L E N I S T S
 P V D I C O F M W L U A S P S
 L Z E V T H I A M C H L R M C
 E Y G N M H R T M J G E T Q A
 S O A S W E J I U I A Q F P T
 C P R O P H E T S C N P O B T
 H R U W G P Y P H T E E R T E
 L C O E B A K I K H I S U H R
 U C C H H K N G N M Q A R J E
 A U N Z P G Z K I U J W N E D
 B B E J N W U L I J W E A S P

ADDED
 ANTIOCH
 BARNABAS
 CHRISTIANS
 DISCIPLES
 ENCOURAGED

FAITH
 FAMINE
 HELLENISTS
 HOLY SPIRIT
 JEWS
 LORD JESUS

PERSECUTION
 PREACHING
 PROPHETS
 RELIEF
 SAUL
 SCATTERED

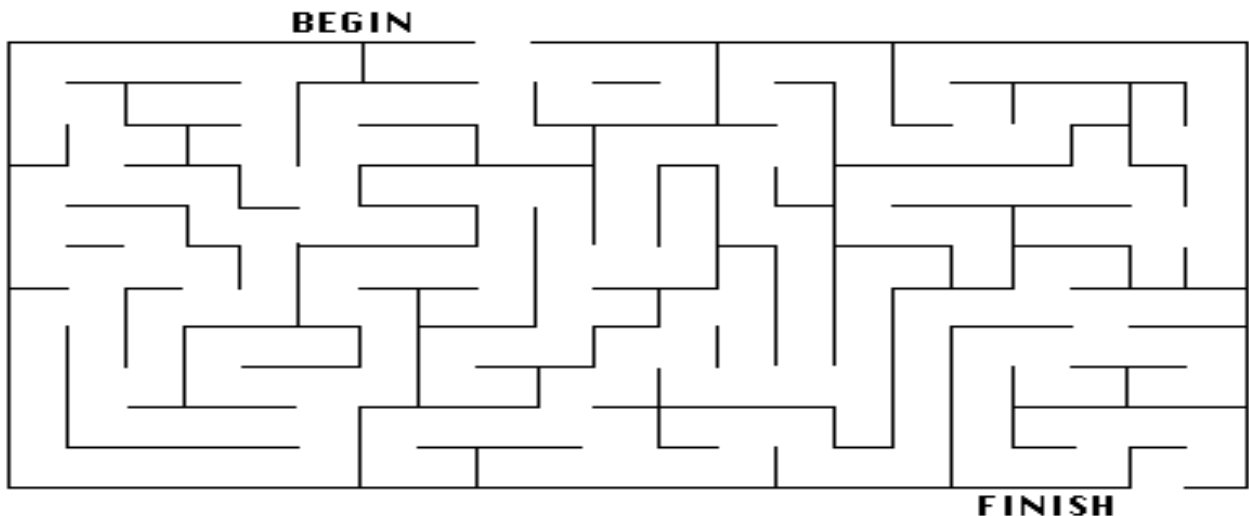

256. THE CHURCH IN ANTIOCH (ACTS 11:19-30)

MEMORY VERSE:

"And the hand of the Lord was with them, and a great number believed and turned to the Lord." ACTS 11:21

FILL IN THE BLANKS:

1. "Now those who were _____ after the persecution that arose over Stephen traveled as far as Phoenicia, Cyprus, and Antioch, preaching the word to no one but the Jews only."
ACTS 11:19
2. "But some of them were men from Cyprus and Cyrene, who, when they had come to Antioch, spoke to the Hellenists, preaching the _____."
ACTS 11:20

TRUE OR FALSE:

3. "And the hand of the Lord was with them, and a great number believed and _____ turned to the Lord."
ACTS 11:21

TRUE OR FALSE

FILL IN THE BLANKS:

4. "Then news of these things came to the ears of the church in Jerusalem, and they sent out _____ to go as far as Antioch."
ACTS 11:22
5. "When he came and had seen the _____ of God, he was glad, and encouraged them all that with purpose of heart they should continue with the Lord."
ACTS 11:23
6. "Then Barnabas departed for Tarsus to seek Saul. And when he had found him, he brought him to _____. So it was that for a whole year they assembled with the church and taught a great many people..."
ACTS 11:25-26

TRUE OR FALSE:

7. "...And the disciples were first called Christians in Antioch."
ACTS 11:25-26

TRUE OR FALSE

256. THE CHURCH IN ANTIOCH

(ACTS 11:19-30)

Q N F Q Q Y F B M U B W M S G G R T J A Z Q M Y D
 S D V C T B U B A D E T G O T H D W P V F N P E K
 Q R I U H B T R S L H L O T B B C B Z K V R M A G
 V A O J T P O E S U T C H R I S T I A N S U L E C
 P Z S B T P E C V F L A V W W V G M F U F B C Q M
 B E N E R P A R Y L U S A U L S S S A B A N R A B
 Q M H S L T M N S G N I H C A E R P B O H B S U N
 J D I M T P J C B E W A S I I U Q L B Z N I G T Q
 I W U E R Y I V W Y C O D H U B H U B B E F E V R
 C Q R J W F B C L H Q U P D M H E G M D E W Y S U
 T E A T P A G C S B N A T J E U L C Z E M L U E M
 D B F A N R N C W I I P T I F D L V B G J J W T E
 C I F A B O E T W O D A W D O Q E U I A Q B I K S
 J T L U B J H L I I S D B U O N N B Z R V B A S Z
 W A T O C W G H I O V Y H O E T I N F U E B C W P
 Y L Q E R S D H O E C S J L P P S H Z O V J L E J
 J B H N D D V R Z L F H Y O F L T B B C V K P J H
 T Z A Q W S J E O E Y M B A B J S A D N L U A N D
 N Z U B B I B E N R U S I U J B U U B E A M I B C
 A N U N I A G I S F U T P I F J M V B A I B E Y U
 S K T A E G M M A U H U P I Y H J A U M L Y Y Z U
 L O T Y P A C Q B Y S B G I R T Q E Y Z R R A A S
 P B D Q F W Z N U B A S B B T I L I E B U T Q X Y
 U P R O P H E T S D D E G R W J T S E T U T A U J
 T H D U I A H Y N F D J P W U Y J G J P C C O E G

ADDED
ANTIOCH
BARNABAS
CHRISTIANS
DISCIPLES
ENCOURAGED

FAITH
FAMINE
HELLENISTS
HOLY SPIRIT
JEWS
LORD JESUS

PERSECUTION
PREACHING
PROPHETS
RELIEF
SAUL
SCATTERED

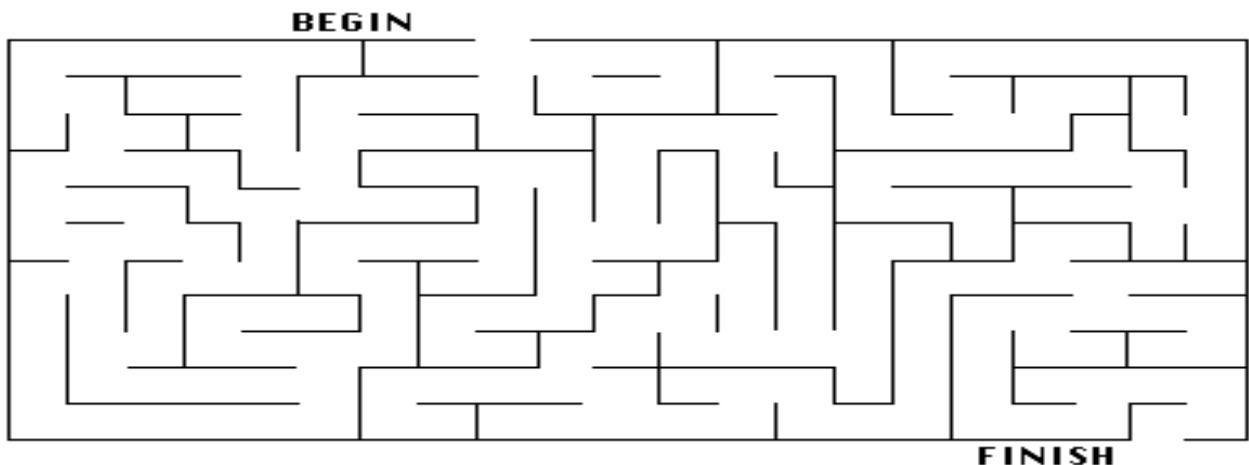

256. THE CHURCH IN ANTIOCH (ACTS 11:19-30)

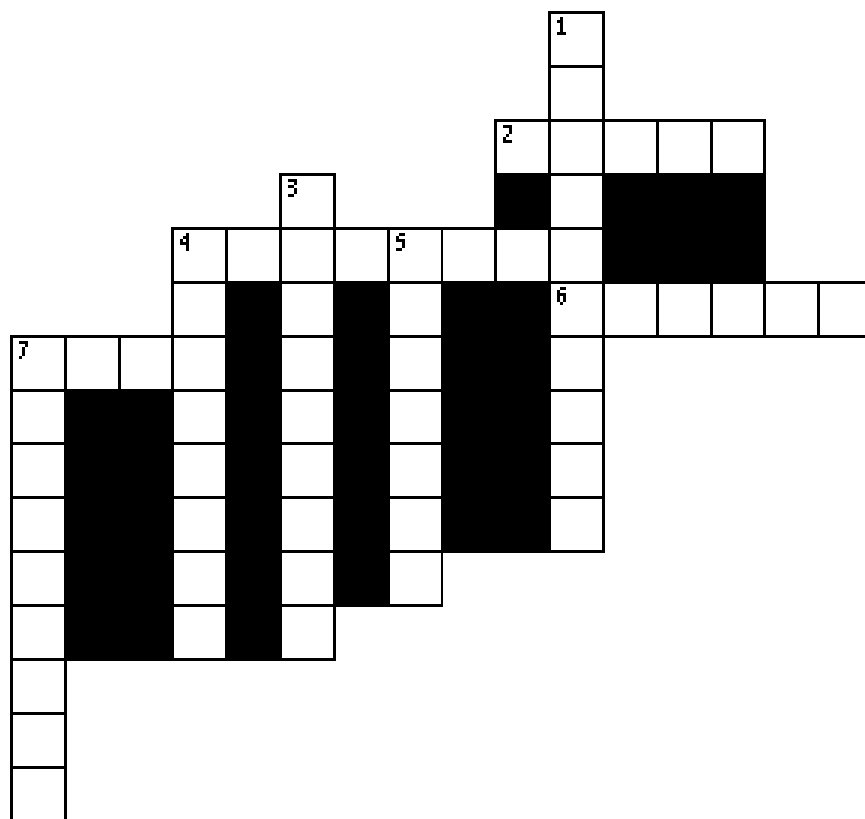

- 7 DOWN "Now those who were _____ after the persecution that arose over Stephen traveled as far as Phoenicia, Cyprus, and Antioch, preaching the word to no one but the Jews only." **ACTS 11:19**
- 3 DOWN "But some of them were men from Cyprus and Cyrene, who, when they had come to Antioch, spoke to the Hellenists, _____ the Lord Jesus." **ACTS 11:20**
- 4 DOWN "And the hand of the Lord was with them, and a great number _____ and turned to the Lord." **ACTS 11:21**
- 4 ACROSS "Then news of these things came to the ears of the church in Jerusalem, and they sent out _____ to go as far as Antioch." **ACTS 11:22**
- 2 ACROSS "When he came and had seen the _____ of God, he was glad, and encouraged them all that with purpose of heart they should continue with the Lord." **ACTS 11:23**
- 7 ACROSS "Then Barnabas departed for Tarsus to seek _____." **ACTS 11:25**
- 5 DOWN "And when he had found him, he brought him to _____." **ACTS 11:26**
- 6 ACROSS "So it was that for a whole year they assembled with the church and _____ a great many people..." **ACTS 11:26**
- 1 DOWN "...And the disciples were first called _____ in Antioch." **ACTS 11:25-26**

Bible Story 257

**PETER
IS RELEASED
FROM PRISON**

Acts 12:1-19

257. PETER IS RELEASED FROM PRISON

(ACTS 12:1-19)



"And, behold, the angel of the Lord came upon *him*, and a light shined in the prison:
and he smote Peter on the side, and raised him up, saying, Arise up quickly.
And his chains fell off from *his* hands."

ACTS 12:7

257. PETER IS RELEASED FROM PRISON

(ACTS 12:1-19)

MEMORY VERSE:

"And when Peter had come to himself, he said, 'Now I know for certain that the Lord has sent His angel, and has delivered me from the hand of Herod and from all the expectation of the Jewish people.' " ACTS 12:11

CIRCLE THE CORRECT WORD:

1. "Now about that time (**HAROLD, HEROD**) the king stretched out his hand to harass some of the church."
ACTS 12:1

TRUE OR FALSE:

2. "Then he killed James the brother of John with the sword." ACTS 12:2
TRUE OR FALSE
3. And because he saw that it displeased the Jews, he proceeded further to free Peter also... ACTS 12:3
TRUE OR FALSE

CIRCLE THE CORRECT WORDS:

4. "So when he had apprehended him, he put him in (**PRISON, STORAGE**), and delivered him to four squads of soldiers to keep him, intending to bring him before the people after Passover." ACTS 12:4
5. "Peter was therefore kept in prison, but constant (**PRAYER, ACCUSATION**) was offered to God for him by the church." ACTS 12:5

TRUE OR FALSE:

6. "And when Herod was about to bring him out, that night Peter was sleeping, bound with two chains between two soldiers; and the guards before the door were keeping the prison." ACTS 12:6
TRUE OR FALSE

CIRCLE THE CORRECT WORD:

7. "Now behold, an angel of the Lord stood by him, and a light shone in the prison; and he struck Peter on the side and raised him up, saying, 'Arise quickly!' And his (**GLOVES, CHAINS**) fell off his hands." ACTS 12:7

TRUE OR FALSE:

8. "When they were past the first and the second guard posts, they came to the iron gate that leads to the city, which opened to them of its own accord; and they went out and went down one street, and immediately the angel departed from him." ACTS 12:10
TRUE OR FALSE
9. "But when Herod had searched for him and not found him, he examined the guards and commanded that they should be put to death..." ACTS 12:19
TRUE OR FALSE

257. PETER IS RELEASED FROM PRISON

(ACTS 12:1-19)

P A S S O V E R I B R G S N X
B I Q A L T K N O C K I N G S
L R S L C B C J J Q L W U W F
M O N B N D M G I K U T O F P
E N I R E I E Z U L C R K H N
J T A E R U U R J A D D C J I
L V H T H K A T E E R R Y A D
D B C E T B K P B V U D F M L
Z K H P E B I R B H I C S E G
P C E F R F E I C S R L D S R
E E R H B Y L S K I L L E D A
B U O V A A O O J E W S Q D F
L Z D R G Y Z N R Z K V N Y W
I B P O J B I T A N G E L V V
A E D E I S O L D I E R S Y B

ANGEL
BRETHREN
CHAINS
CHURCH
DELIVERED
GOD

GUARDS
HEROD
JAMES
JEWS
KILLED
KNOCKING

PASSOVER
PETER
PRAYER
PRISON
SOLDIERS
SWORD

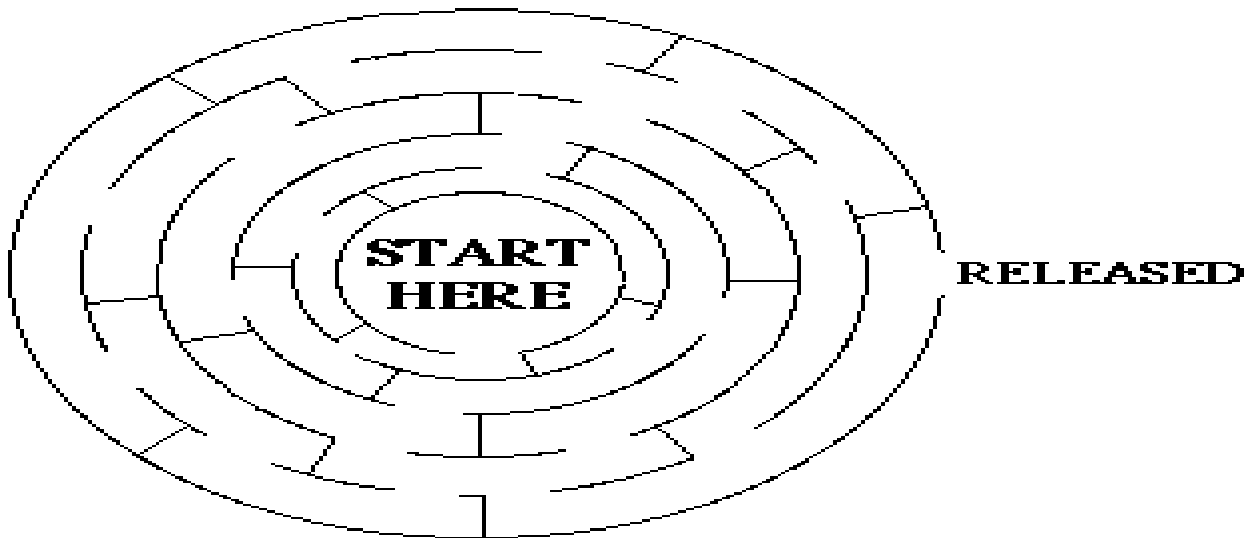

257. PETER IS RELEASED FROM PRISON

(ACTS 12:1-19)

MEMORY VERSE:

"And when Peter had come to himself, he said, 'Now I know for certain that the Lord has sent His angel, and has delivered me from the hand of Herod and from all the expectation of the Jewish people.' " ACTS 12:11

FILL IN THE BLANK:

1. "Now about that time _____ the king stretched out his hand to harass some of the church."
ACTS 12:1

TRUE OR FALSE:

2. "Then he killed James the brother of John with the sword." ACTS 12:2
TRUE OR FALSE
3. And because he saw that it displeased the Jews, he proceeded further to free Peter also... ACTS 12:3
TRUE OR FALSE

FILL IN THE BLANKS:

4. "So when he had apprehended him, he put him in _____, and delivered him to four squads of soldiers to keep him, intending to bring him before the people after Passover." ACTS 12:4
5. "Peter was therefore kept in prison, but constant _____ was offered to God for him by the church." ACTS 12:5

TRUE OR FALSE:

6. "And when Herod was about to bring him out, that night Peter was sleeping, bound with two chains between two soldiers; and the guards before the door were keeping the prison." ACTS 12:6
TRUE OR FALSE

FILL IN THE BLANK:

7. "Now behold, an angel of the Lord stood by him, and a light shone in the prison; and he struck Peter on the side and raised him up, saying, 'Arise quickly!' And his _____ fell off his hands." ACTS 12:7

TRUE OR FALSE:

8. "When they were past the first and the second guard posts, they came to the iron gate that leads to the city, which opened to them of its own accord; and they went out and went down one street, and immediately the angel departed from him." ACTS 12:10
TRUE OR FALSE
9. "But when Herod had searched for him and not found him, he examined the guards and commanded that they should be put to death..." ACTS 12:19
TRUE OR FALSE

257. PETER IS RELEASED FROM PRISON (ACTS 12:1-19)

O S Y C Z F T U P O D Q U H O T D W H Q X D F K S
 J L O T E V D E N J V N D T A W U I U L A K H B G
 Q K A C M I D N G W B Y L L P B O U Q J U X N I E
 S W V J D A Q Q C N G P A S S O V E R T V U E F Y
 P V S W W O N H K S I M U U A H L M T W A Y E W U
 M J C N Q N U G B S C K P E T E R D E L L I K L W
 B B A Y I R C B E I Z A C W D J O F P K E E M J I
 B W L J C A U N C L H S F O Y Y U O L M I E J B A
 O E O H B H H A D A O V L Q N K I E J L S J Q B C
 H L Z T I I J C W G K F Y N S K I P B N G A V K L
 S G O D P R I S O N S Y T I M P B K J E J V E J P
 S V M N T U K Y K W K D H H U G R J H R P K V K A
 R D F A A A S Q I A R K R S E K W F T H Z U V U I
 V D P S L F E U E F E W B A B L G Y J T F O L M E
 N Z M R B F M D P U N L O V U G O T Y E B Z A B Y
 G Z Q L A T A Q E T C W I U S G T R R R B B I Y A
 D O S P Z Y J T I L V W R U E P K W D B K A L R Q
 P W Q U Z Q E H Y O I Z F A J S S U D U M M R T A
 K H V T N H S R B M C V Y D M O R G C G Z Z U T O
 S Q P N K W S T B J C O E D G T E H G C X B U C Y
 P I B D E A M D P K H A B R O W I B S V I T C M E
 P L Q J O U J T R G R K D W E I D V Q U Z P Q P A
 R H J R B U T R P O E U F T V D L S U B F Z N M E
 B H E R O D A R Y H W N B L S H O U M N Z F R L Q
 O T I A H T A W F G M S E A P J S B J H B V B C U

ANGEL OF THE LORD
 BRETHREN
 CHAINS
 CHURCH
 DELIVERED
 GOD

GUARDS
 HEROD
 JAMES
 JEWS
 KILLED
 KNOCKING

PASSOVER
 PETER
 PRAYER
 PRISON
 SOLDIERS
 SWORD

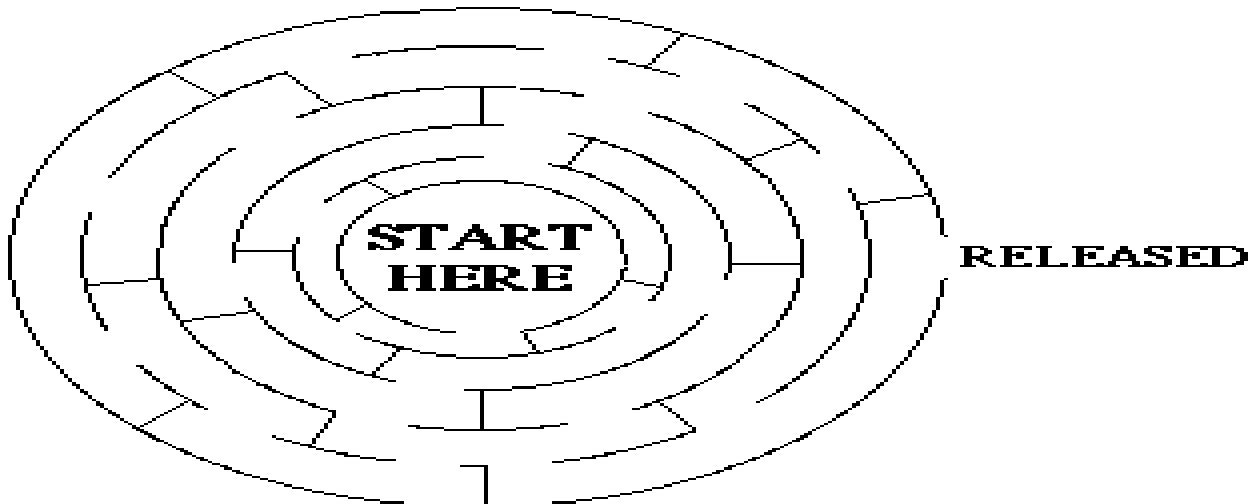

257. PETER IS RELEASED FROM PRISON

(ACTS 12:1-19)

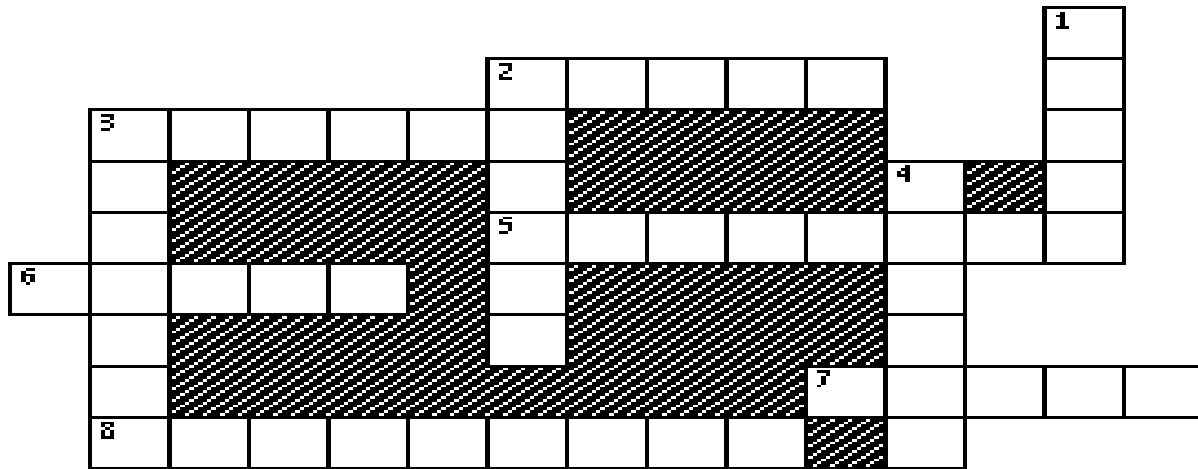

- 1 DOWN "Now about that time _____ the king stretched out his hand to harass some of the church." **ACTS 12:1**
- 6 ACROSS "Then he killed _____ the brother of John with the sword." **ACTS 12:2**
- 3 DOWN "And because he saw that it _____ the Jews, he proceeded further to seize Peter also..." **ACTS 12:3**
- 2 DOWN "So when he had apprehended him, he put him in _____, and delivered him to four squads of soldiers to keep him, intending to bring him before the people after Passover." **ACTS 12:4**
- 3 ACROSS "Peter was therefore kept in prison, but constant _____ was offered to God for him by the church." **ACTS 12:5**
- 2 ACROSS "And when Herod was about to bring him out, that night _____ was sleeping, bound with two chains between two soldiers; and the guards before the door were keeping the prison." **ACTS 12:6**
- 4 DOWN "Now behold, an angel of the Lord stood by him, and a light shone in the prison; and he struck Peter on the side and raised him up, saying, 'Arise quickly!' And his _____ fell off his hands." **ACTS 12:7**
- 7 ACROSS "When they were past the first and the second guard posts, they came to the iron gate that leads to the city, which opened to them of its own accord; and they went out and went down one street, and immediately the _____ departed from him." **ACTS 12:10**
- 8 ACROSS "And when Peter had come to himself, he said, 'Now I know for certain that the Lord has sent His angel, and has _____ me from the hand of Herod and from all the expectation of the Jewish people.'" **ACTS 12:11**
- 5 ACROSS "But when Herod had _____ for him and not found him, he examined the guards and commanded that they should be put to death..." **ACTS 12:19**

Bible Story 258

PAUL'S FIRST MISSIONARY JOURNEY

Acts 12:25 - 13:52

258. PAUL'S FIRST MISSIONARY JOURNEY (ACTS 12:25-13:52)



"As they ministered to the Lord, and fasted, the Holy Ghost said, Separate me Barnabas and Saul for the work whereunto I have called them." **ACTS 13:2**

"So they, being sent forth by the Holy Ghost, departed unto Seleucia; and from thence they sailed to Cyprus." **ACTS 13:4**

258. PAUL'S FIRST MISSIONARY JOURNEY

(ACTS 12:25-13:52)

MEMORY VERSE:

"For so the Lord has commanded us: 'I have set you to be a light to the Gentiles, that you should be for salvation to the ends of the earth.' " ACTS 13:47

CIRCLE THE CORRECT WORDS:

1. "Now in the church that was at (**ANTIOCH, PHILIDELPHIA**) there were certain prophets and teachers: Barnabas, Simeon who was called Niger, Lucius of Cyrene, Manaen who had been brought up with Herod the tetrarch, and Saul." **ACTS 13:1**
2. "As they ministered to the Lord and fasted, the (**PEOPLE, HOLY SPIRIT**) said, 'Now separate to Me Barnabas and Saul for the work to which I have called them.' " **ACTS 13:2**

TRUE OR FALSE:

3. "So, being sent out by the Holy Spirit, they went down to Seleucia, and from there they sailed to Cyprus." **ACTS 13:4**
TRUE OR FALSE
4. "And when they arrived in Salamis, they preached the word of God in the synagogues of the Jews. They also had John as their assistant." **ACTS 13:5**
TRUE OR FALSE

CIRCLE THE CORRECT WORDS:

5. "Now when Paul and his party set sail from Paphos, they came to Perga in Pamphylia; and John (**STAYING, DEPARTING**) from them, returned to Jerusalem." **ACTS 13:13**
6. "But when they departed from Perga, they came to Antioch in Pisidia, and went into the (**SYNAGOGUE, POOL**) on the Sabbath Day and sat down."

TRUE OR FALSE:

7. "And after the reading of the Law and the Prophets, the rulers of the synagogue sent to them, saying, 'Men and brethren, if you have any word of exhortation for the people, say on.' " **ACTS 13:15**
TRUE OR FALSE
8. "Then Paul stood up, and motioning with his hand said, Men of Israel, and you who fear God, listen." **ACTS 13:16**
TRUE OR FALSE

CIRCLE THE CORRECT WORDS:

9. "And when the Jews went out of the synagogue, the (**EGYPTIANS, GENTILES**) begged that these words might be preached to them the next Sabbath." **ACTS 13:42**
10. "And the next Sabbath almost the whole city came together to hear the word of God. But when the Jews saw the multitudes, they were filled with (**JOY, ENVY**); and contradicting and blaspheming, they opposed the things spoken by Paul." **ACTS 13:45**
11. "But the Jews stirred up the devout and prominent women and chief men of the city, raised up persecution against Barnabas and Paul, and (**EXPULSED, HID**) them from their region." **ACTS 13:50**
12. "And the (**JEWS, DISCIPLES**) were filled with joy and the Holy Spirit." **ACTS 13:52**

258. PAUL'S FIRST MISSIONARY JOURNEY (ACTS 12:25-13:52)

G N B L D M P M I L U A S B C Y I S U Y
 O E L X I E T E J O H N M A R K D S Z S
 J V N I P S Y J R E T A I R R F I B D D
 S M R T L D L A O Q S Y J X K M L W U Q
 Z U S U I C U L R A D B Z Q E D G S C B
 N O Q V E L Z N N P N C T O G Q T D G Y
 W X C V P Q E L O T A M N K W N R L A J
 I M R T K E T S I I H U T L T N O I J P
 M A N A E N T R T L T A I E D R A A O A
 O G H L S H I A Y B B U J S I F F J Y V
 V P A U L P T R R F I P C F C Y W T B T
 M Q N C S E T D V A B P I E V V V L F P
 G O N Y N S B Z B H P E R Z S Y B N L G
 D T L M I D S P K V D E L E S R Q J I F
 O O V N U E M E C E U I S I A B E O H K
 H H I G W T H B E L K D I R E C J P V K
 T M G K S S V L U C B L R L U V H I M O
 C K R M C A Y I Z J B O J O K F E E E C
 U W K P T F B A B I F Z X U L P C D D T
 V W Z E P N L B A R N A B A S N A M Y N

BARNABAS
 BELIEVED
 DUST
 FASTED
 GENTILES
 GLORIFIED
 HANDS

HOLY SPIRIT
 JOHN MARK
 JOY
 LORD
 LUCIUS
 MANAEN
 MINISTRY

PAUL
 PERSECUTION
 PRAYED
 PREACHED
 SAUL
 SEPARATE
 SIMEON

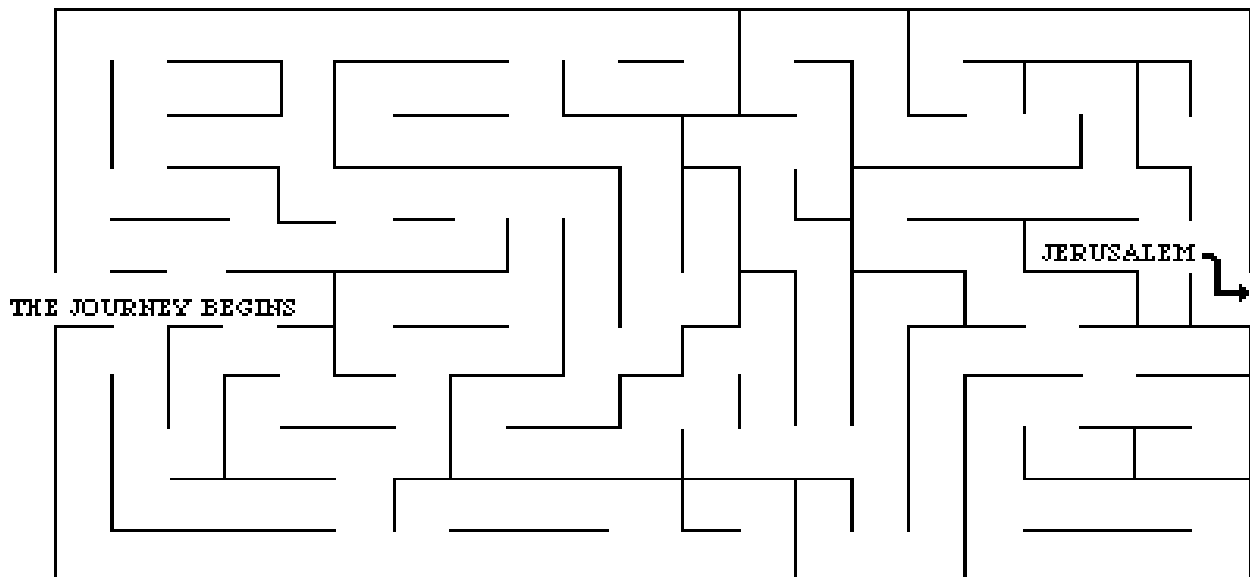

258. PAUL'S FIRST MISSIONARY JOURNEY

(ACTS 12:25-13:52)

MEMORY VERSE:

"For so the Lord has commanded us: 'I have set you to be a light to the Gentiles, that you should be for salvation to the ends of the earth.' " ACTS 13:47

FILL IN THE BLANKS:

1. "Now in the church that was at Antioch there were certain _____ and _____: Barnabas, Simeon who was called Niger, Lucius of Cyrene, Manaen who had been brought up with Herod the tetrarch, and Saul." **ACTS 13:1**
2. "As they ministered to the Lord and fasted, the _____ said, 'Now separate to Me Barnabas and Saul for the work to which I have called them.' " **ACTS 13:2**

TRUE OR FALSE:

3. "So, being sent out by the Holy Spirit, they went down to Seleucia, and from there they sailed to Cyprus." **ACTS 13:4**
TRUE OR FALSE
4. "And when they arrived in Salamis, they preached the word of God in the synagogues of the Jews. They also had John as their assistant." **ACTS 13:5**
TRUE OR FALSE

FILL IN THE BLANKS:

5. "Now when Paul and his party set sail from Paphos, they came to Perga in Pamphylia; and John _____ from them, returned to Jerusalem." **ACTS 13:13**
6. "But when they departed from Perga, they came to Antioch in Pisidia, and went into the _____ on the Sabbath Day and sat down."

TRUE OR FALSE:

7. "And after the reading of the Law and the Prophets, the rulers of the synagogue sent to them, saying, 'Men and brethren, if you have any word of exhortation for the people, say on.' " **ACTS 13:15**
TRUE OR FALSE
8. "Then Paul stood up, and motioning with his hand said, Men of Israel, and you who fear God, listen." **ACTS 13:16**
TRUE OR FALSE

FILL IN THE BLANKS:

9. "And when the Jews went out of the synagogue, the _____ begged that these words might be preached to them the next Sabbath." **ACTS 13:42**
10. "And the next Sabbath almost the whole city came together to hear the word of God. But when the Jews saw the multitudes, they were filled with _____; and contradicting and blaspheming, they opposed the things spoken by Paul." **ACTS 13:45**
11. "But the Jews stirred up the devout and prominent women and chief men of the city, raised up persecution against Barnabas and Paul, and _____ them from their region." **ACTS 13:50**
12. "And the _____ were filled with joy and the Holy Spirit." **ACTS 13:52**

258. PAUL'S FIRST MISSIONARY JOURNEY (ACTS 12:25-13:52)

O H R J C U O I Y T C A P H W K T J N K J P S P B M M D T N
 B E O G J B B B W H A S B Y S D L S B N F M L T O J A C I Q
 Z A Z A T B V O Y Z B M K J G N O J P O J P W G V W H R D D
 Z T G Z H T D E D N N U S T T M R E T I Q S G S B W L D L C
 N E E T H G H J S M B Z U G B U D F G T L S F P Z O E E C U
 O H C U L B Q L T B I O I P U G Y H C U L N L B O S U S L A
 E D J J Z G B B T O G L O R I F I E D C B Z M U A Z R S K E
 M I X Q R A K N W M B B I M C S U B U E R Y L K C S U B A I
 I L P K L L Q Z N C G H Y R G Q B M A S Y M C K R I W R D H
 S Q D P R E A C H E D W U Y B P I H Q R M R B V Y U U S P T
 V S J K P L I H G A A C W L A H G T O E Q Y P M B D A S R J
 X Z P V J V J Z O C H E Y E K B R D A P U F F T V U G J H B
 O G D H Z J G Q F L Q R F H E B E L B J U Q T P L C N F Q K
 A I Q S S C O B O B Y Z Y R N Q Y T B P M D F A S T E D B K
 O K A T Z D P H B X Q S O I Y T K Q R F R W V Z R Q H H N P
 H W F O U B N B N N Y D P V I Y C F J G I M R K L Q E P N E
 B B A L P B C A R M U B S I Y J O Y D E T A R A P E S M B I
 W N H S F B Q P H S A P U K R O D E A R C G K R N H H S A G
 B K D T Q F I M T I C R B T Q I V R H N B R S O Q Q B P G Q T
 K C W R N H I G N M L M K R S E T D B C Q L J Y M S Q J H G
 Y H Y B B N S A B A N R A B I E O H Z D J R D D V B P N C M
 N P F Z I O Y D S Q V B U L W B B K H S U Y D U S F R U G Y
 B U Z S Q C R T A F B U E A U Q F P P O V M D P C O A O I B
 J M T U C G N M G U O B G L K P K P Y M R P W F L Z Y F I O
 J R W O J E G E N T I L E S T W Q P J L F N C L S F E O J Q
 Y J G W A S O P L N B F O J P Q U R U W J S N S D O D L P Z
 G B Z N Y M I U U U I S B K E B S B G R S I S W M G F V B H
 J O A E C E T R W Q A U N S B O R J P J A S P U V T M C Z N
 V M T C T Z E P O G B P T V O G T L C W O J C F C V G P F I
 N J T U G B H T W T B Y D H G B F Q M H I M K B U A G F U W

BARNABAS
 BELIEVED
 DUST
 FASTED
 GENTILES
 GLORIFIED
 HANDS

HOLY SPIRIT
 JOHN MARK
 JOY
 LORD
 LUCIUS
 MANAEN
 MINISTRY

PAUL
 PERSECUTION
 PRAYED
 PREACHED
 SAUL
 SEPARATE
 SIMEON

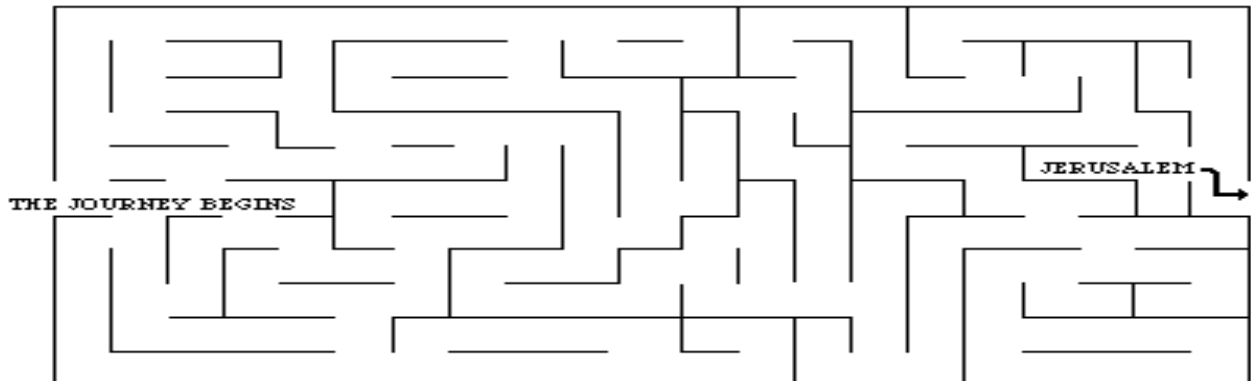

258. PAUL'S FIRST MISSIONARY JOURNEY (ACTS 12:25-13:52)

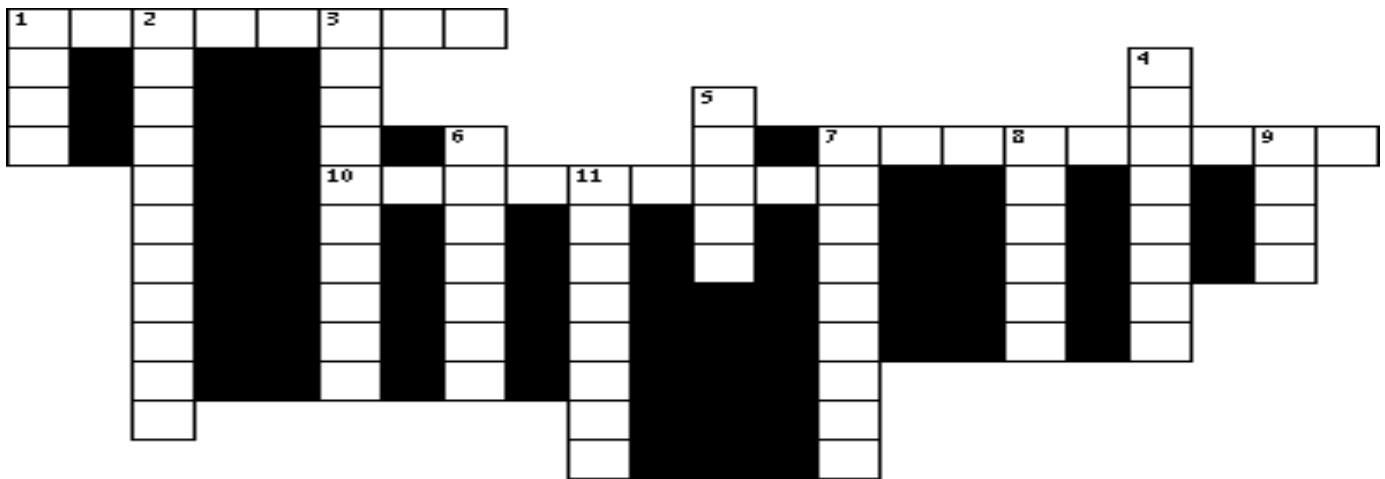

- 6 DOWN "Now in the church that was at _____ there were certain prophets and teachers..." **ACTS 13:1**
- 3 DOWN "As they ministered to the Lord and fasted, the _____ said, 'Now separate to Me Barnabas and Saul for the work to which I have called them.'" **ACTS 13:2**
- 8 DOWN "So, being sent out by the Holy Spirit, they went down to Seleucia, and from there they sailed to _____." **ACTS 13:4**
- 1 ACROSS "And when they arrived in Salamis, they _____ the word of God in the synagogues of the Jews. They also had John as their assistant." **ACTS 13:5**
- 7 DOWN "Now when Paul and his party set sail from Paphos, they came to Perga in Pamphylia; and John _____ from them, returned to Jerusalem." **ACTS 13:13**
- 10 ACROSS "But when they departed from Perga, they came to Antioch in Pisidia, and went into the _____ on the Sabbath Day and sat down." **ACTS 13:14**
- 2 DOWN "...the rulers of the synagogue sent to them, saying, 'Men and brethren, if you have any word of _____ for the people, say on.'" **ACTS 13:15**
- 1 DOWN "Then _____ stood up, and motioning with his hand said, 'Men of Israel, and you who fear God, listen.'" **ACTS 13:16**
- 11 DOWN "And when the Jews went out of the synagogue, the _____ begged that these words might be preached to them the next Sabbath." **ACTS 13:42**
- 9 DOWN "...But when the Jews saw the multitudes, they were filled with _____; and contradicting and blaspheming, they opposed the things spoken by Paul." **ACTS 13:45**
- 5 DOWN "...I have set you to be a _____ to the Gentiles,..." **ACTS 13:47**
- 4 DOWN "But the Jews stirred up the devout and prominent women and chief men of the city, raised up persecution against Barnabas and Paul, and _____ them from their region." **ACTS 13:50**
- 7 ACROSS "And the _____ were filled with joy and the Holy Spirit." **ACTS 13:52**

Bible Story 259

**THE
JERUSALEM
COUNCIL**

Acts 15:1-29

259. THE JERUSALEM COUNCIL (ACTS 15:1-29)



"And the apostles and elders came together for to consider of this matter."
ACTS 15:6

259. THE JERUSALEM COUNCIL

(ACTS 15:1-29)

MEMORY VERSE:

"But we believe that through the grace of the Lord Jesus Christ we shall be saved in the same manner as they." ACTS 15:11

TRUE OR FALSE:

1. "And certain men came down from Judea and taught the brethren, 'Unless you are circumcised according to the custom of Moses, you cannot be saved.'" **ACTS 15:1**
TRUE OR FALSE

CIRCLE THE CORRECT WORD:

2. "Therefore, when Paul and Barnabas had no small dissension and dispute with them, they determined that Paul and Barnabas and certain others of them should go up to (JERUSALEM, BETHLEHEM), to the apostles and elders, about this question." **ACTS 15:2**

TRUE OR FALSE:

3. But the apostles and elders did not come together to consider this matter. **ACTS 15:6**
TRUE OR FALSE

CIRCLE THE CORRECT WORDS:

4. "Now therefore, why do you test God by putting a (YOKE, CHOKE) on the neck of the disciples which neither our fathers nor we were able to bear?" **ACTS 15:10**
5. *"But we believe that through the grace of the Lord Jesus Christ we shall be (LOST, SAVED) in the same manner as they."* **ACTS 15:11**

TRUE OR FALSE:

6. "And after they had become silent, James answered, saying, 'Men and brethren, listen to me: Simon has declared how God at the first visited the Gentiles to take out of them a people for His name.'" **ACTS 15:13-14**
TRUE OR FALSE
7. "For it seemed good to the Holy Spirit, and to us, to lay upon you no greater burden than these necessary things: that you abstain from things offered to idols, from blood, from things strangled, and from immorality. If you keep yourselves from these, you will do well."
ACTS 15:28-29
TRUE OR FALSE

259. THE JERUSALEM COUNCIL

(ACTS 15:1-29)

U J G M I R A C L E S N E S Y
F A I T H R B A R N A B A S P
F M Q E K G W D E V A S P B Z
A A A N C Y T I L A R O M M I
M R T G T S T R A N G L E D E
T U M H P I I Q J P F V C L I
Q N E O E H R D L M I A D Q C
Y N L H S R A I O B A E O B S
O R A L U E S R P L R O O M R
K S S W A Q S A I S S W L I E
E R U Z E W E B F S Y E B T D
P E R G T A J M Z R E L V N N
B T E G E N T I L E S E O B O
T E J V N F N M A Z B T S H W
H P S E L T S O P A U L T P X

APOSTLES
BARNABAS
BLOOD
ELDERS
FAITH
FATHERS

GENTILES
HEART
HOLY SPIRIT
IDOLS
IMMORALITY
PETER

JERUSALEM
LAW
MIRACLES
MOSES
PAUL

PHARISEES
SAVED
STRANGLED
WONDERS
YOKE

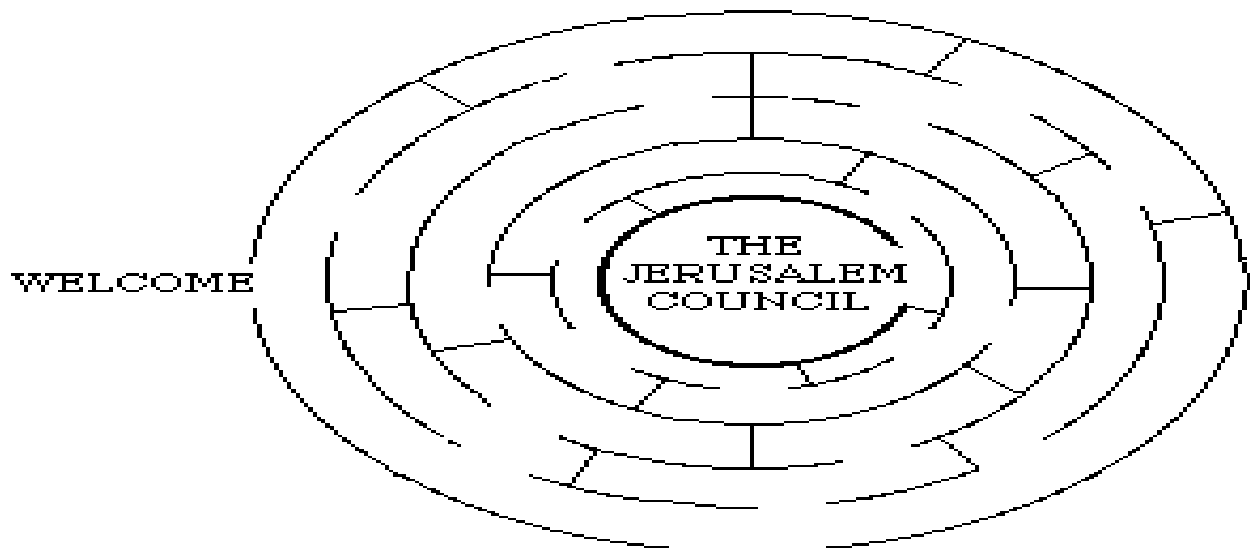

259. THE JERUSALEM COUNCIL

(ACTS 15:1-29)

MEMORY VERSE:

"But we believe that through the grace of the Lord Jesus Christ we shall be saved in the same manner as they." ACTS 15:11

TRUE OR FALSE:

1. "And certain men came down from Judea and taught the brethren, 'Unless you are circumcised according to the custom of Moses, you cannot be saved.'" **ACTS 15:1**
TRUE OR FALSE

FILL IN THE BLANK:

2. "Therefore, when Paul and Barnabas had no small dissension and dispute with them, they determined that Paul and Barnabas and certain others of them should go up to _____, to the apostles and elders, about this question." **ACTS 15:2**

TRUE OR FALSE:

3. But the apostles and elders did not come together to consider this matter. **ACTS 15:6**
TRUE OR FALSE

FILL IN THE BLANKS:

4. "Now therefore, why do you test God by putting a _____ on the neck of the disciples which neither our fathers nor we were able to bear?" **ACTS 15:10**
5. "But we believe that through the grace of the Lord Jesus Christ we shall be _____ in the same manner as they." **ACTS 15:11**

TRUE OR FALSE:

6. "And after they had become silent, James answered, saying, 'Men and brethren, listen to me: Simon has declared how God at the first visited the Gentiles to take out of them a people for His name.'" **ACTS 15:13-14**
TRUE OR FALSE
7. "For it seemed good to the Holy Spirit, and to us, to lay upon you no greater burden than these necessary things: that you abstain from things offered to idols, from blood, from things strangled, and from immorality. If you keep yourselves from these, you will do well."
ACTS 15:28-29
TRUE OR FALSE

259. THE JERUSALEM COUNCIL

(ACTS 15:1-29)

B W L Z S E E S I R A H P S Y O E C E J M S Z C S
 H I R A B T F S S E F C R F J J N W S B M A E O E
 Z B Z A P C I Q E D Q E E O A L C A U H M B T B J
 Y U P W P V E T Y L H B Y B L N B A R Z X T Q U M
 Q W D C Y S V B T T T B B V C A B V B J O Q H M B
 P N H H J H M B A K N S P E N A C H M L R T D P T
 V Y M H V D N F G J I V O R Q Y C W T L H I D A B
 M D Y O D L I K R D I K A P Y O T B K I P B S J K
 V H O F E H M S O Y G B B H A T B P N B A A F Y Q
 O I K B L Z J L R Z H G N C Y L I F B Y N F N K A
 T I E B G E S I K Y O V Y K A P W L H C T C V Q Q
 J A Y Z N H C S U R L E Q W V B R W A Z Y D W K T
 Z L U G A E W B P B Y A Q Z F E S A O R L N T Y V
 O N K F R A G W S I S B F M D A Q B L N O V U O I
 V F S B T R G J Q D P Y E J Q Q U E A U D M R O J
 L R S C S T V F V A I M Z A D T R G G A A E M Y I
 C D V B J S B K Y D R O H P B L O O D J C P R I Z
 E K Y Z E Q I G E G I S F N I S G G K L O B K S V
 G S Z A R U F V E M T E M E D C L H S T Y C I D L
 V F N K U Z A N E D J S C P B T Y B U A Y V Z Y G
 R B O I S S T A Z S R E D L E B F Y L E C C U U N
 E Y W L A I B Z P I L Z G B V H B B M L Y A W O N
 T D K U L F L I A R D R J U W G O S E L C A R I M
 E C I E E N Y N U G K Q O U Z A W A O B D W A X Y
 P P S H M M E T Y K G V B H F K B P T D W Z T Z T

APOSTLES
BARNABAS
BLOOD
ELDERS
FAITH
FATHERS

GENTILES
HEART
HOLY SPIRIT
IDOLS
IMMORALITY
PETER

JERUSALEM
LAW
MIRACLES
MOSES
PAUL

PHARISEES
SAVED
STRANGLER
WONDERS
YOKE

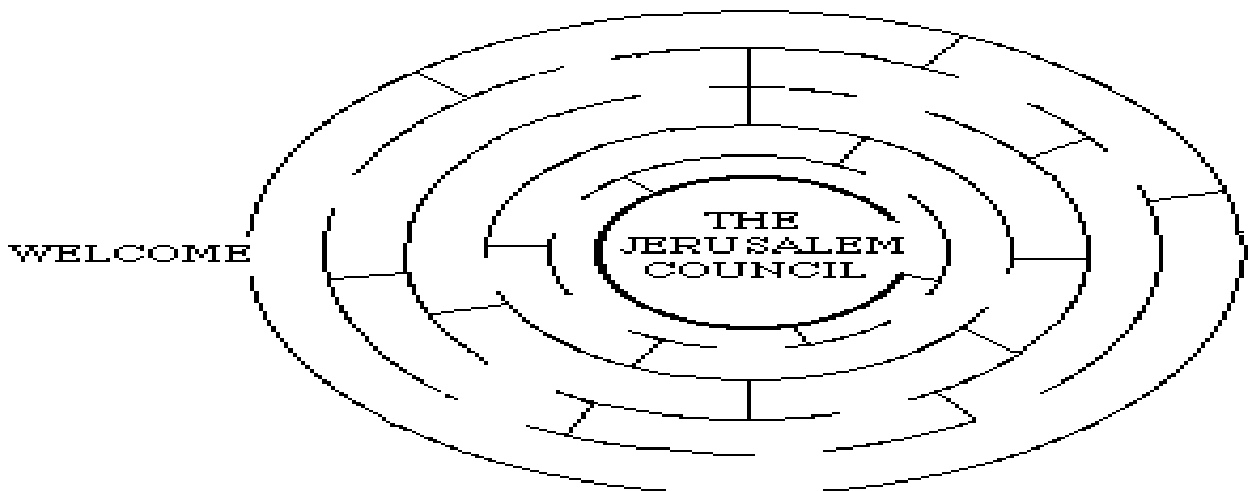

259. THE JERUSALEM COUNCIL

(ACTS 15:1-29)

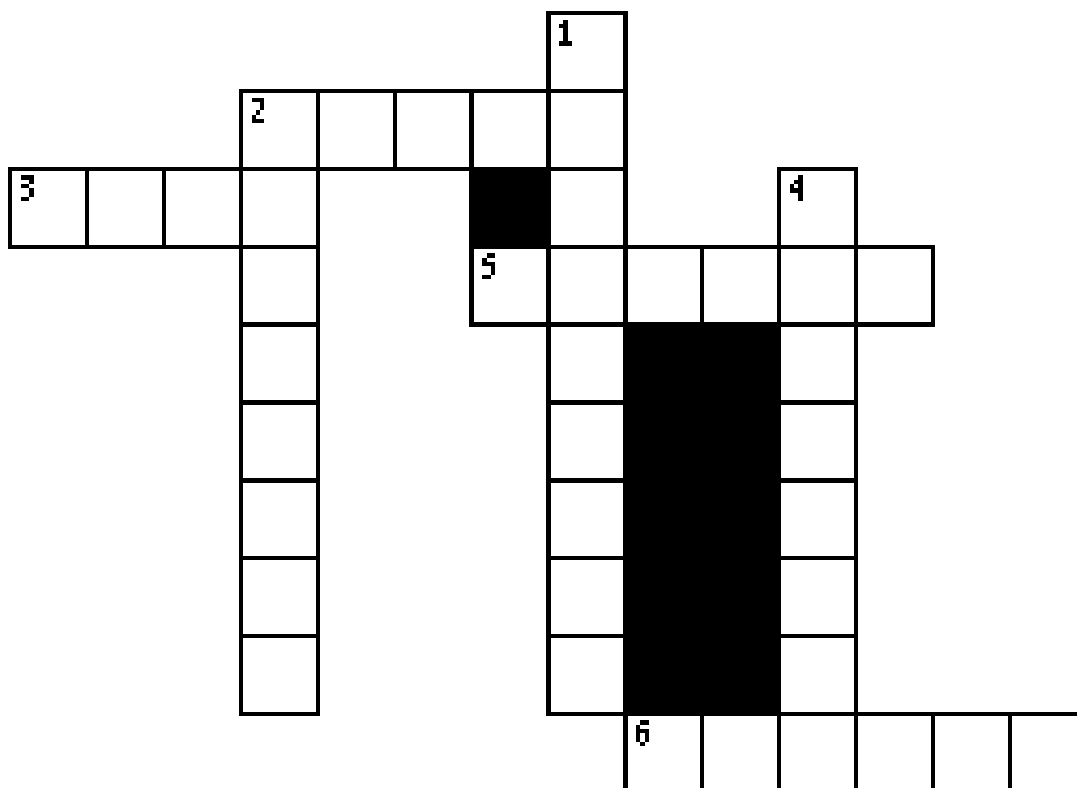

- 5 ACROSS "And certain men came down from Judea and taught the brethren, 'Unless you are circumcised according to the _____ of Moses, you cannot be saved.'" **ACTS 15:1**
- 1 DOWN "Therefore, when Paul and Barnabas had no small dissension and dispute with them, they determined that Paul and Barnabas and certain others of them should go up to _____, to the apostles and elders, about this question." **ACTS 15:2**
- 4 DOWN "So the apostles and elders came _____ to consider this matter." **ACTS 15:6**
- 3 ACROSS "Now therefore, why do you test God by putting a _____ on the neck of the disciples which neither our fathers nor we were able to bear?" **ACTS 15:10**
- 2 ACROSS "But we believe that through the _____ of the Lord Jesus Christ we shall be saved in the same manner as they." **ACTS 15:11**
- 2 DOWN "And after they had become silent, James answered, saying, 'Men and brethren, listen to me: Simon has declared how God at the first visited the _____ to take out of them a people for His name.'" **ACTS 15:13-14**
- 6 ACROSS "For it seemed good to the Holy Spirit, and to us, to lay upon you no greater _____ than these necessary things: that you abstain from things offered to idols, from blood, from things strangled, and from immorality. If you keep yourselves from these, you will do well." **ACTS 15:28-29**

Bible Story 260

**TIMOTHY
JOINS
PAUL & SILAS**

Acts 16:1-5

260. TIMOTHY JOINS PAUL AND SILAS (ACTS 16:1-5)



"So the churches were in the faith, and increased in number daily."
ACTS 16:5

260. TIMOTHY JOINS PAUL AND SILAS (ACTS 16:1-5)

MEMORY VERSE:

"So the churches were in the faith, and increased in number daily." ACTS 16:5

TRUE OR FALSE:

1. "Then he came to Derbe and Lystra. And behold, a certain disciple was there, named Timothy..." ACTS 16:1

TRUE OR FALSE

CIRCLE THE CORRECT WORD:

2. "...the son of a certain Jewish woman who (**BELIEVED, DENIED**), but his father was Greek." ACTS 16:1

TRUE OR FALSE:

3. He was ill spoken of by the brethren who were at Lystra and Iconium. ACTS 16:2

TRUE OR FALSE

4. "Paul wanted to have him go on with him..." ACTS 16:3

TRUE OR FALSE

CIRCLE THE CORRECT WORD:

5. "And as they went through the cities, they delivered to them the (**DECREES, FOOD**) to keep, which were determined by the apostles and elders at Jerusalem." ACTS 16:4

TRUE OR FALSE:

6. "So the churches were strengthened in the faith, and increased in number daily." ACTS 16:5

TRUE OR FALSE

260. TIMOTHY JOINS PAUL AND SILAS

(ACTS 16:1-5)

J Y H T O M I T L U X T Y P W
E V J P W W Y N M M A E Y L E
W M J J D U B G S D C J O J B
I A E H Y E D Z Z L W K J C R
S Z E L P I C S I D J K F V E
H S G G P F R R F D A I L Y D
A H A R Z I C J E S U P A T V
Y M W E E B G P P E K Z H W M
Y D E S A E R C N I S M A H F
O B L U W G K N G V O U H P S
F S H T I A F B K R I I Z J S
V V Z W B Y R O B C P N Y H I
C H U R C H E S B M A O N Q L
B O B D M P G F B L U C J O A
S A R T S Y L L C B L I T A S

CHURCHES

DAILY

DECREES

DERBE

DISCIPLE

FAITH

GREEK

ICONIUM

INCREASED

TIMOTHY

JEWISH

LYSTRA

PAUL

SILAS

260. TIMOTHY JOINS PAUL AND SILAS (ACTS 16:1-5)

MEMORY VERSE:

"So the churches were in the faith, and increased in number daily." ACTS 16:5

TRUE OR FALSE:

1. "Then he came to Derbe and Lystra. And behold, a certain disciple was there, named Timothy..." ACTS 16:1

TRUE OR FALSE

FILL IN THE BLANK:

2. "...the son of a certain Jewish woman who _____, but his father was Greek."
ACTS 16:1

TRUE OR FALSE:

3. He was ill spoken of by the brethren who were at Lystra and Iconium. ACTS 16:2

TRUE OR FALSE

4. "Paul wanted to have him go on with him..." ACTS 16:3

TRUE OR FALSE

FILL IN THE BLANK:

5. "And as they went through the cities, they delivered to them the _____ to keep, which were determined by the apostles and elders at Jerusalem." ACTS 16:4

TRUE OR FALSE:

6. "So the churches were strengthened in the faith, and increased in number daily." ACTS 16:5

TRUE OR FALSE

260. TIMOTHY JOINS PAUL AND SILAS

(ACTS 16:1-5)

U P O D P D Q A P B K D D P U P M J Z U T Y M P T G B Z A C
G U H D B W H Y P G W F Y S M L L P B C T A N L F B K U D N
I Y S Z Q Q A Q Y C L B S O F J U Z A Q C Q Q J H I M I P U
C F S Z L B U U F Y G E M I C O N I U M M A R D D V I J U K
E K R U J I J Q O R H H U T O B L F M N P O U D R S U L K S
U T A O I T U E E Z W T B W E J Y B Z R M Y M R S M B M I U
B P V W C A T E W H W T O I P H S B B U L E E M M K W P B N
M G N H T L K T J I Z L S M K T T K T K C A S J C I V B R E
K E G Q C B T H W K S U E H I J R M P B S S E E R C E D Q S
U Y D I J Z D T S K O H J J J T A Z Z I G E Z L U R K E I B
Y G P L W Z D T S R A W W D F Y G B F F D Q P P R K G C J T
Y M K H Y N Q R I E K Q M O Y R C I V W I U J S S Q P H L I
R Q S T J K C R A N U N S U M D V Z F L S T H E J Y H M J L
F H P Y T O U W G C N I G A T A U F H J C V D H L C K B V E
H V P O N B J P W V U S O O L C N Z N B I S C C P Z H I R I
E V R A A H K N A C D V V L W I B B E B P E U R B A C V R A
L G D V S F S K I C L U S O U G S D E K L T U U N K O M K K
M S B A L V M B F N U U P U G S N K M J E K S H S R V T J Q
G N O C I I J C U H C A T I H Q H B J K E N Y C L V N Q S Y
M B S A P L T D T R F R W I B U B U Q U Y B J O P Z J V F R
B K L L U O Y W O E L D E H T I A F V R U Y G L H Y L U Q X
P K K O T N A K M M Y D B A V M A Y E E W Z A T L E D G V T
M O W Z N H A I J Q H W H B S J U E V H I A K P Q H R B B P
W J V M D I U E K N B T J R S E V E V T A B R N U Z Z D R K
N Q J F R U E P G Y O L Y W U Q D J L A C U B R I C B O B Z
G S B M A A N I E M I A K G B L A A A F L E N A C S Y N I O
K P W Q Z F Q B H A R O P T H J E V I M P D Y P C G A Z U V
B M E S E F R Y G S F A B K U T I K L B A K N L M I E F Q L
Y B L Q M E B B D V Y P K W Q W S U R Y I G M Y R F M N H C
K B V V D T N B V Y B A G I T K G O U R E C Q M B L B B C Y

CHURCHES

DAILY

DECREES

DERBE

DISCIPLE

FAITH

FATHER

GREEK

ICONIUM

INCREASED

JEWISH WOMAN

LYSTRA

PAUL

SILAS

TIMOTHY

260. TIMOTHY JOINS PAUL AND SILAS (ACTS 16:1-5)

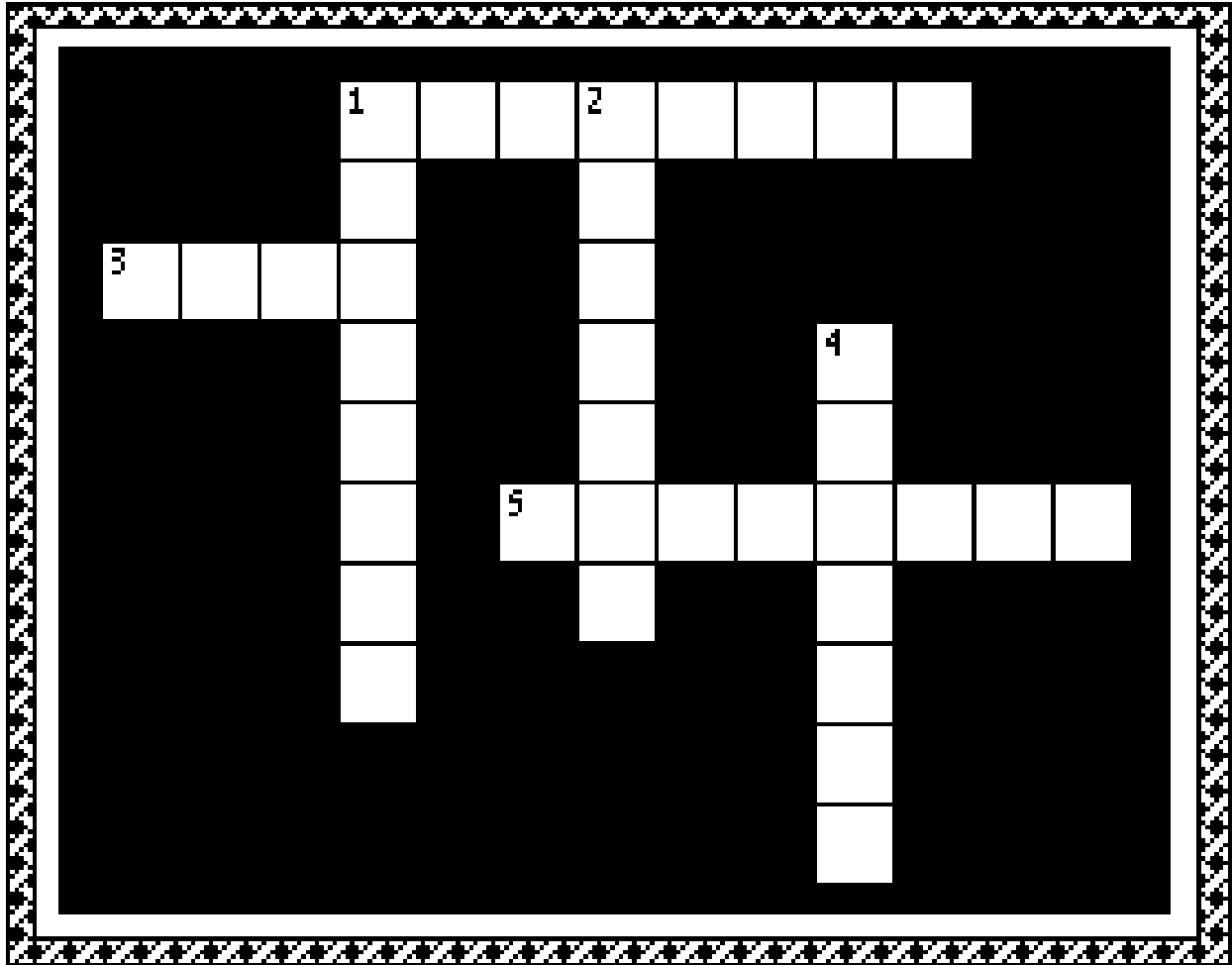

- 2 DOWN "Then he came to Derbe and Lystra. And behold, a certain disciple was there, named _____." **ACTS 16:1**
- 1 DOWN "...the son of a certain Jewish woman who _____, but his father was Greek." **ACTS 16:1**
- 1 ACROSS "He was well spoken of by the _____ who were at Lystra and Iconium." **ACTS 16:2**
- 3 ACROSS "_____ wanted to have him go on with him..." **ACTS 16:3**
- 4 DOWN "And as they went through the cities, they delivered to them the _____ to keep, which were determined by the apostles and elders at Jerusalem." **ACTS 16:4**
- 5 ACROSS "So the _____ were strengthened in the faith, and increased in number daily." **ACTS 16:5**

Bible Story 261

**THE CALL
TO
MACEDONIA**

Acts 16:6-10

261. THE CALL TO MACEDONIA

(ACTS 16:6-10)



"And a vision appeared to Paul in the night; There stood a man of Macedonia, and prayed him, saying, Come over into Macedonia, and help us."

ACTS 16:9

261. THE CALL TO MACEDONIA

(ACTS 16:6-10)

MEMORY VERSE:

"Go therefore and make disciples of all the nations, baptizing them in the name of the Father and of the Son and of the Holy Spirit, teaching them to observe all things that I have commanded you; and lo, I am with you always, even to the end of the age." Amen.

MATTHEW 28:19-20

CIRCLE THE CORRECT WORD:

1. "Now when they had gone through Phrygia and the region of Galatia, they were **(FORBIDDEN, LED)** by the Holy Spirit to preach the word in Asia." **ACTS 16:6**

TRUE OR FALSE:

2. "After they had come to Mysia, they tried to go into Bithynia, but the Spirit did not permit them." **ACTS 16:7**

TRUE OR FALSE

3. So stopping in Mysia, they rested. **ACTS 16:8**

TRUE OR FALSE

CIRCLE THE CORRECT WORD:

4. "And a **(STAR, VISION)** appeared to Paul in the night..." **ACTS 16:9**

TRUE OR FALSE:

5. "...A man of Macedonia stood and pleaded with him, saying, 'Come over to Macedonia and help us.'" **ACTS 16:9**

TRUE OR FALSE

CIRCLE THE CORRECT WORD:

6. "Now after he had seen the vision, immediately we sought to go to Macedonia, concluding that the **(MAN, LORD)** had called us to preach the gospel to them." **ACTS 16:10**

261. THE CALL TO MACEDONIA

(ACTS 16:6-10)

P P T L O R D P J V B F B L M
 R V V K M E V I S I O N W O O
 Y G G Y Q U I A V E V Q D P O
 R Y S S S A I N O D E C A M F
 E I W Y T N P Q F G B E I D U
 A Q D B Y I K O A Z M B C Q H
 B D K H S V R L H O W H P C D
 V O T F O B A I C U Y M A J P
 T I A L I T R F P U U E L J L
 B O G D I F E R Y S R G E C E
 O K D A E I N C G P Y Q P B H
 J E S K Z U A G M I K L S V A
 N P A P E R M I T B Y W O D S
 Q Z U I P H I O B Q H G G H I
 L S S A O R T W U L U A P I A

ASIA
 BITHYNIA
 COME
 FORBIDDEN
 GALATIA
 GOSPEL

HELP
 HOLY SPIRIT
 LORD
 MACEDONIA
 MYSIA

PAUL
 PERMIT
 PREACH
 TROAS
 VISION

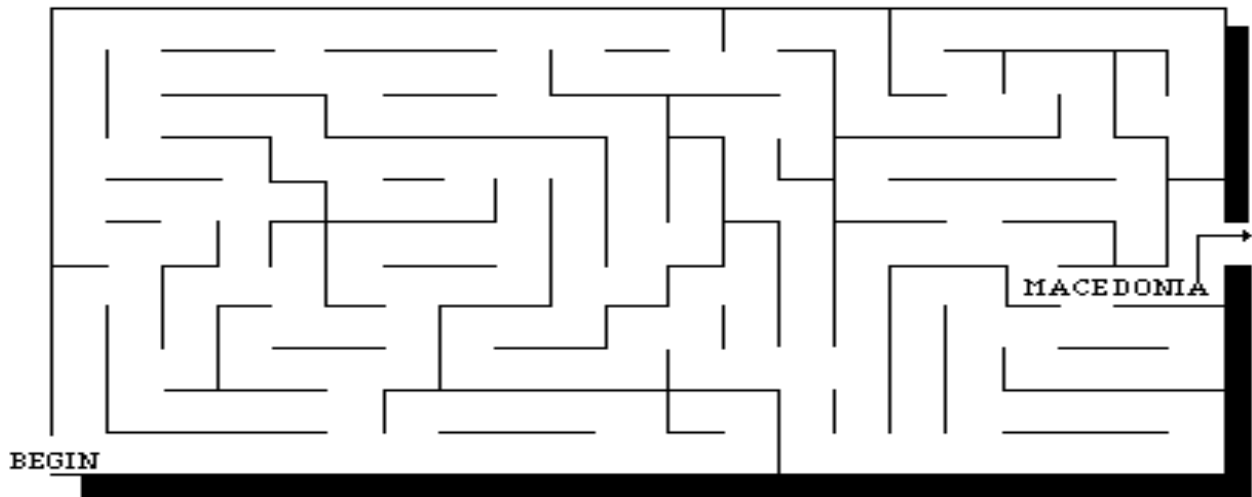

261. THE CALL TO MACEDONIA

(ACTS 16:6-10)

MEMORY VERSE:

"Go therefore and make disciples of all the nations, baptizing them in the name of the Father and of the Son and of the Holy Spirit, teaching them to observe all things that I have commanded you; and lo, I am with you always, even to the end of the age." Amen.
MATTHEW 28:19-20

FILL IN THE BLANK:

1. "Now when they had gone through Phrygia and the region of Galatia, they were _____ by the Holy Spirit to preach the word in Asia." **ACTS 16:6**

TRUE OR FALSE:

2. "After they had come to Mysia, they tried to go into Bithynia, but the Spirit did not permit them." **ACTS 16:7**

TRUE OR FALSE

3. So stopping in Mysia, they rested. **ACTS 16:8**

TRUE OR FALSE

FILL IN THE BLANK:

4. "And a _____ appeared to Paul in the night..." **ACTS 16:9**

TRUE OR FALSE:

5. "...A man of Macedonia stood and pleaded with him, saying, 'Come over to Macedonia and help us.'" **ACTS 16:9**

TRUE OR FALSE

FILL IN THE BLANK:

6. "Now after he had seen the vision, immediately we sought to go to Macedonia, concluding that the _____ had called us to preach the gospel to them." **ACTS 16:10**

261. THE CALL TO MACEDONIA

(ACTS 16:6-10)

M W W Z Q T D G C O G M R G L T B K Y J K V Z P V E D K S E
 O P B H L F D I V F H G Q K Z V F L V T Y B F Z Z D G S D H
 Y W B R A Z V C G B G D C M T B A E Y L J T L V R B W J R M
 D V Y A L B V N W Q N O M P T K Y S B N P G Q Q K I Z F F U
 V G K E L C D E H R W T Y E B C B Z F J A H P Q Q E Z A R N N
 U J Y A M S K B H K B C S I S E C R P O V Q S U G F K C V C
 B T T J M O B P A D W U I P M U M L N I T Z B S I A Z R V A
 S F P Y S L C U I N B T A L H Z U U I T I M R E P K E B B J
 S G S G O S S U N F O V I E V B A C D M P T U D V Q I L W K
 O J J H A N H R O H V I R R Y E K R L U G W D E M T A S J R
 V W V S L P P J D L B N S P I Q I L U A P V Z B H S H P B L
 Z J D E K M P R E A C H H I B P L K G Z F B O Y V W V E E C
 D H T Q N N P Z C D H V N K V A S G R S K W N B D Y L F D B
 C G T M M Q R F A I C M N S L L O Y A D K I X U R U V Z C X
 B B Q B G Q B J M P O U A N M B Z O L C A M U Q O F R L V B
 O A F X G H N F B M Y I V U E F R W A O O V O J L I E V H U
 P B N C T V G E B W T O G W J T I T F A H Z B A O E R O H J
 O H F B E Z B O B A K B R S L H J D W B C Q T D V O T L A Y
 R P T B L U L R L L E M K C D V Z C V F T B L I O Z Q Z H Z
 J T H Y S D L A U G O G Z T Z E T V B L N U R O F E S J B D
 Y Q D U V F G I L S J Q L P P L T S Q N E D D I B R O F E D
 M X T W P H N Y Y Z S O B M E C I U J I B W F B B R W P U H
 G O N D Z G B S L R Z T I S B J J K C H U D F E J I S E D I
 U N Y O S G O Y H O N H V D L I I Y A V Q Y Z O Y Y J N J G
 U C B K M U Z S X J W K P Q I T J F S M D N R N T M R R T A
 O B P J B Q S D P L I L V H A B B D B E Y K F R B S Q B Q F
 V B B Q A J V Y K E E W T E I I B Q W Y C P M L H I U I B W
 V I U B K V M B K H L W L N R U R N D Y Z H C B Q L S R U Z
 R F L Z I Q O O B L O B C P O K B N I S Y Q R D A N O B V W
 F A N P Y D N J D A V L M T N B Q F A Q S O I A I S A V D R

ASIA
 BITHYNIA
 COME
 FORBIDDEN
 GALATIA
 GOSPEL

HELP
 HOLY SPIRIT
 LORD
 MACEDONIA
 MYSIA

PAUL
 PERMIT
 PREACH
 TROAS
 VISION

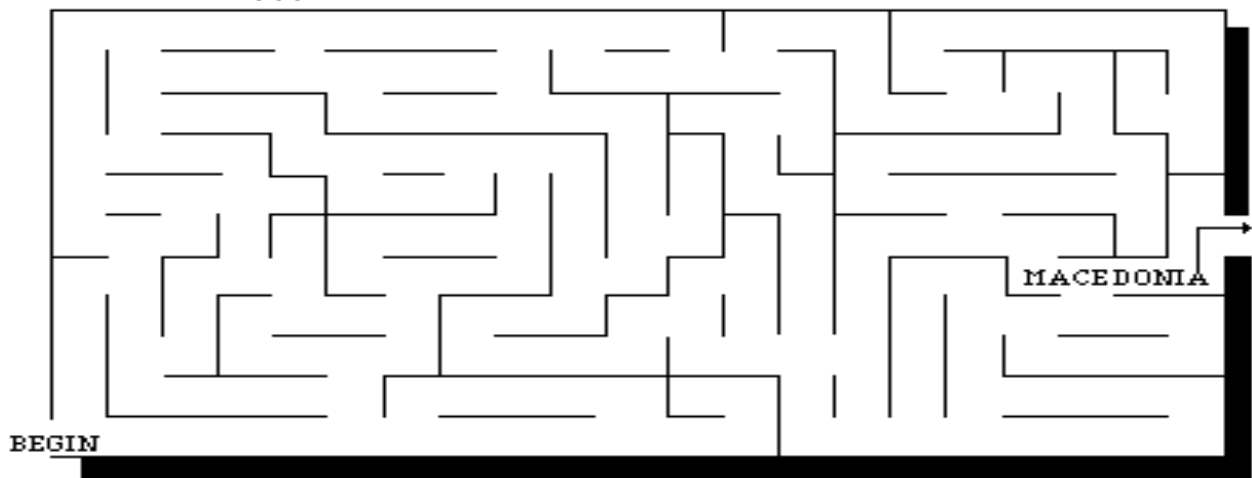

261. THE CALL TO MACEDONIA

(ACTS 16:6-10)

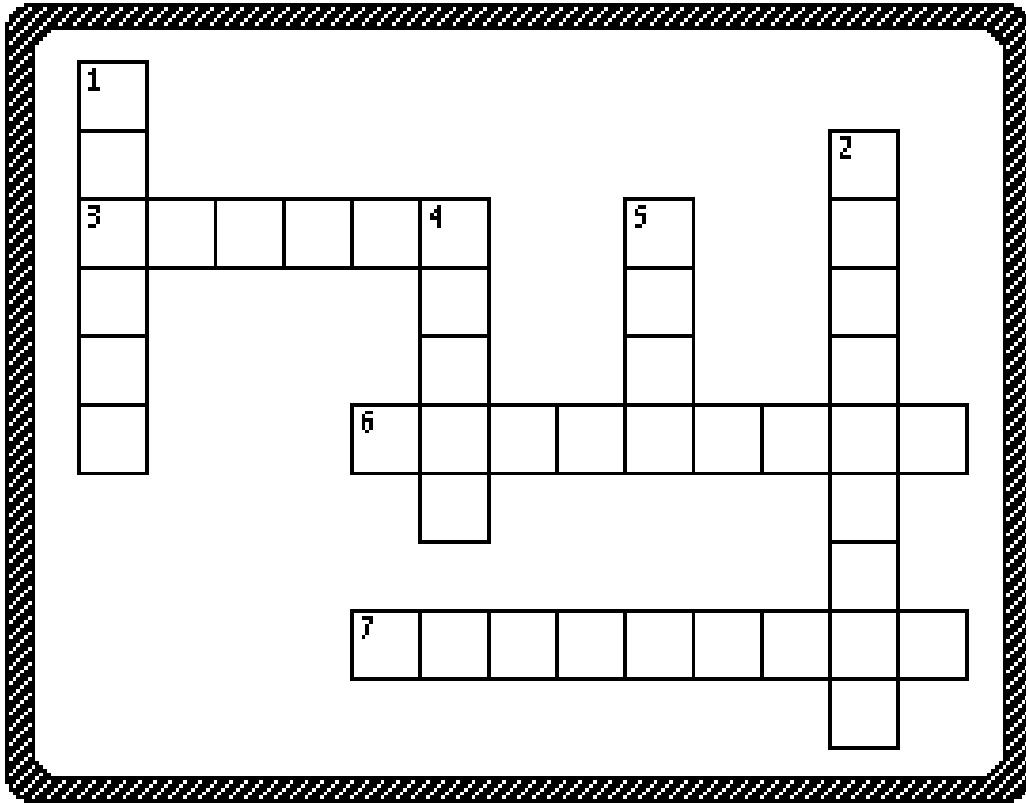

- 2 DOWN "Go therefore and make _____ of all the nations, baptizing them in the name of the Father and of the Son and of the Holy Spirit, teaching them to observe all things that I have commanded you; and lo, I am with you always, even to the end of the age.' Amen." **MATTHEW 28:19-20**
- 7 ACROSS "Now when they had gone through Phrygia and the region of Galatia, they were _____ by the Holy Spirit to preach the word in Asia." **ACTS 16:6**
- 3 ACROSS "After they had come to Mysia, they tried to go into Bithynia, but the _____ did not permit them." **ACTS 16:7**
- 4 DOWN "So passing by Mysia, they came down to _____." **ACTS 16:8**
- 1 DOWN "And a _____ appeared to Paul in the night..." **ACTS 16:9**
- 6 ACROSS "...A man of _____ stood and pleaded with him, saying, 'Come over to Macedonia and help us.' " **ACTS 16:9**
- 5 DOWN "Now after he had seen the vision, immediately we sought to go to Macedonia, concluding that the _____ had called us to preach the gospel to them." **ACTS 16:10**

Bible Story 262

**PAUL & SILAS
ARE
IMPRISONED**

Acts 16:16-40

262. PAUL AND SILAS ARE IMPRISONED (ACTS 16:16-40)



"And when they had laid many stripes upon them, they cast *them* into prison, charging the jailor to keep them safely:"

ACTS 16:23

262. PAUL AND SILAS ARE IMPRISONED

(ACTS 16:16-40)

MEMORY VERSE:

"So they said, 'Believe on the Lord Jesus Christ and you will be saved, you and your household.' "
ACTS 16:31

CIRCLE THE CORRECT WORDS:

1. "This girl followed Paul and us, and cried out, saying, 'These men are the (**ENEMIES, SERVANTS**) of the the Most High God, who proclaim to us the way of salvation.' " **ACTS 16:17**
2. "When her masters saw that their hope for profit was gone, they (**SEIZED, THANKED**) Paul and Silas and dragged them into the marketplace to the authorities." **ACTS 16:19**

TRUE OR FALSE:

3. Then the multitude rose up together for them; and the magistrates put on their best clothes and commanded them to be fed a feast. **ACTS 16:22**

TRUE OR FALSE

CIRCLE THE CORRECT WORD:

4. "Suddenly there was a great earthquake, so that the foundations of the prison were shaken; and immediately all the doors were opened and everyone's chains were (**LOOSED, TIGHTENED**)." **ACTS 16:26**

TRUE OR FALSE:

5. "And he brought them out and said, 'Sirs, what must I do to be saved?' " **ACTS 16:30**

TRUE OR FALSE

6. "So they said, 'Believe on the Lord Jesus Christ, and you will be saved, you and your household.' "
ACTS 16:31

TRUE OR FALSE

CIRCLE THE CORRECT WORD:

7. "So the keeper of the prison reported the words to Paul, saying, 'The magistrates have sent to let you go. Now therefore (**STAY, DEPART**), and go in peace.' " **ACTS 16:36**

TRUE OR FALSE:

8. "So they went out of the prison and entered the house of Lydia; and when they had seen the brethren, they encouraged them and departed." **ACTS 16:40**

TRUE OR FALSE

262. PAUL AND SILAS ARE IMPRISONED

(ACTS 16:16-40)

C J N O I T A V L A S V B U X
G A H Y B P G A L R L W Y R H
J P B V G O D U E R Y B D B A
O N J F V B A T C G F P E M R
B C D D W P S K C N B F V K O
F H E Q Z A E J T I O A A S M
O A Y D M E A A B G W B S I A
B I O P F A R I W N B E B L N
V N N R O Q T L R I C G A A S
E S N A J T H O S S W G P S S
H E A Y L S Q R P R I S O N N
C P A E N C U E B E A T E N M
K B L R A T A N Q G A H E N Y
Z U C I Y B K C P R O F I T H
M U Q D O H E B U E V A L S G

ANNOYED

BEATEN

CHAINS

EARTHQUAKE

GOD

HYMNS

JAILOR

MASTERS

PAUL

PRAYER

PRISON

PROFIT

ROMANS

SALVATION

SAVED

SILAS

SINGING

SLAVE



262. PAUL AND SILAS ARE IMPRISONED

(ACTS 16:16-40)

MEMORY VERSE:

"So they said, 'Believe on the Lord Jesus Christ and you will be saved, you and your household.' "
ACTS 16:31

FILL IN THE BLANKS:

1. "This girl followed Paul and us, and cried out, saying, 'These men are the _____ of the the Most High God, who proclaim to us the way of salvation.' " **ACTS 16:17**
2. "When her masters saw that their hope for profit was gone, they _____ Paul and Silas and dragged them into the marketplace to the authorities." **ACTS 16:19**

TRUE OR FALSE:

3. Then the multitude rose up together for them; and the magistrates put on their best clothes and commanded them to be fed a feast. **ACTS 16:22**

TRUE OR FALSE

FILL IN THE BLANK:

4. "Suddenly there was a great earthquake, so that the foundations of the prison were shaken; and immediately all the doors were opened and everyone's chains were _____." **ACTS 16:26**

TRUE OR FALSE:

5. "And he brought them out and said, 'Sirs, what must I do to be saved?' " **ACTS 16:30**

TRUE OR FALSE

6. "So they said, 'Believe on the Lord Jesus Christ, and you will be saved, you and your household.' "
ACTS 16:31

TRUE OR FALSE

FILL IN THE BLANK:

7. "So the keeper of the prison reported the words to Paul, saying, 'The magistrates have sent to let you go. Now therefore _____, and go in peace.' " **ACTS 16:36**

TRUE OR FALSE:

8. "So they went out of the prison and entered the house of Lydia; and when they had seen the brethren, they encouraged them and departed." **ACTS 16:40**

TRUE OR FALSE

262. PAUL AND SILAS ARE IMPRISONED

(ACTS 16:16-40)

E F L B G I C E J V Q L Q D I B P A I P G F B Q U T Y U Q U
 U E N P M M A I N A U Q F A T H D P H R S W S E B P Y E B A
 T I E Q K W K L B M V F V O B O T Y B I M N G F U N R K L R
 F V T P A Z M Q T O R S B U J T U D M D D B A L G T P I R F
 J D A D B J K V S B I C W G C P N G A U N K J M B S E M A F
 W D E C Y A D Y W L Y I V T F Q B F I M H H S D O G R Y D U
 Q A B B O Q R O U V A C G P F I T Y V U U B H R C R M Q Z B
 T L L L O R L F J O Q G T Z S S Y Q D J M B G F U W G M I H
 F L K G K G C Y N C U C T K Y G Y N Z Q F D L V B T V S B L
 T S Y F O B W U D E S K S N D L Q Q P Z V W A Q L V N A B Q
 O K Z D C V B F T L L V F R B I Y V P A Z W C D Z H O K H G
 W F J B S A I E N W Q D E I B F R L M I C U E J U J I G I V
 S U O Z Y J B F O U E S I N G I N G S A R B S Z N M T I M W
 P D B H H K F F S Q M P I N H M L M B R S V U H V K A T I G
 C G T I F O R P I S B K H G Y B T O F G I T O I B W V Z U L
 W F D F C L B U R P H T Q U U T T N D B M A E O H R L T E K
 L A Y I U G H Q P S A L I S B B J W U Y L E F R E K A A I B
 N R R A Q G F J G O S E Y B L J V D Y O U K P A S A S D M O
 T H P B D J B Y B B I O W R H N N E K A U Q H T R A E Z O B
 E E W P B J A O B J P Y W W U A N N V W T V B S U Z N Y D G
 K C V U B D P C V B C N L H D N B A K A H M L T Z S T S T F
 F S F A K G C C V U M T K P C O N N O B P P P R A Y E R F U
 T T V W L I H Z A I Z H H K D N G M S C K B B D R V Z B Z O
 V P J G V S A C B K E Y H T O Z C L V I B G D Z Q C M L R W
 J L C K H Y I U M J M D R Y I D N R B V A Q N M R M P A M A
 B W M B E U N Q I N L N E B O U V C G N J W H D E O G B Z Q
 C R I D V C S C S K I D J V W W J Z G B P J I O T O L V C F
 D P B Q Q N G R M Q I E I T A G J Q I O N L B U O S B I U G
 G O S F L Y M I H K A G Z N D S Y A O C C B C Y Z Z N Y A E
 N S I I Z H U F H P K H Y C Q B S K G I Z N B B K K I D C J

ANNOYED
 BEATEN
 CHAINS
 EARTHQUAKE
 GOD
 HYMNS

JAILOR
 MASTERS
 PAUL
 PRAYER
 PRISON
 PROFIT

ROMANS
 SALVATION
 SAVED
 SILAS
 SINGING
 SLAVE

262. PAUL AND SILAS ARE IMPRISONED (ACTS 16:16-40)

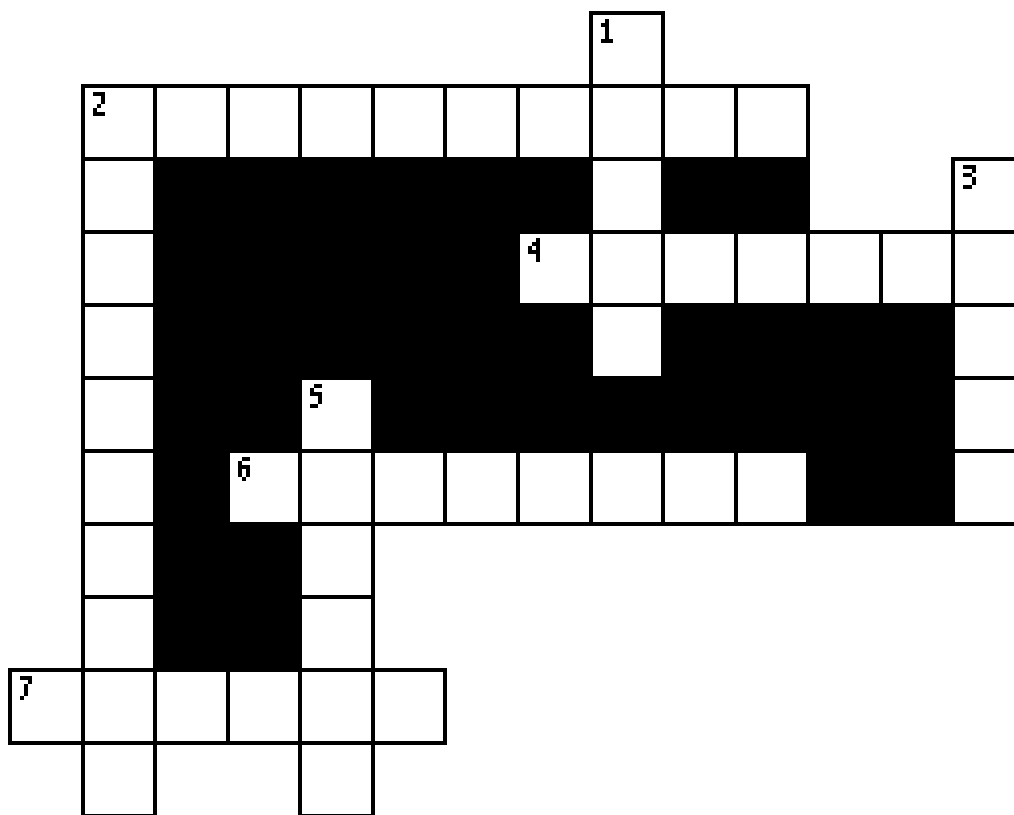

- 6 ACROSS "This girl followed Paul and us, and cried out, saying, 'These men are the _____ of the the Most High God, who proclaim to us the way of salvation.' " **ACTS 16:17**
- 7 ACROSS "When her masters saw that their hope for profit was gone, they _____ Paul and Silas and dragged them into the marketplace to the authorities." **ACTS 16:19**
- 5 DOWN "Then the multitude rose up together against them; and the magistrates tore off their clothes and commanded them to be _____ with rods." **ACTS 16:22**
- 2 ACROSS "Suddenly there was a great _____, so that the foundations of the prison were shaken; and immediately all the doors were opened and everyone's chains were loosed." **ACTS 16:26**
- 1 DOWN "And he brought them out and said, 'Sirs, what must I do to be _____?' " **ACTS 16:30**
- 4 ACROSS "So they said, ' _____ on the Lord Jesus Christ, and you will be saved, you and your household.' " **ACTS 16:31**
- 3 DOWN "So the keeper of the prison reported the words to Paul, saying, 'The magistrates have sent to let you go. Now therefore depart, and go in _____.' " **ACTS 16:36**
- 2 DOWN "So they went out of the prison and entered the house of Lydia; and when they had seen the brethren, they _____ them and departed." **ACTS 16:40**

Bible Story 263

**TO THE
UNKNOWN GOD**

Acts 17:16-34



"Paul explains, ' God, who made the world and everything in it, since He is Lord of heaven and earth, does not dwell in temples made with hands"

Acts 17:24

263. TO THE UNKNOWN GOD (ACTS 17:16-34)

MEMORY VERSE:

"God, who made the world and everything in it, since He is Lord of heaven and earth, does not dwell in temples made with hands." ACTS 17:24

CIRCLE THE CORRECT WORD:

1. "Now while Paul waited for them at Athens, his spirit was provoked within him when he saw that the city was given over to (PHILISTINES, IDOLS)." ACTS 17:16

TRUE OR FALSE:

2. "And they took him and brought him to the Areopagus, saying, 'May we know what this new doctrine is of which you speak?' " ACTS 17:19
TRUE OR FALSE

UNDERLINE THE CORRECT ANSWER:

3. "Then Paul stood in the midst of the Areopagus and said, 'Men of Athens, I perceive that in all things you are very _____.'" ACTS 17:22
- a. rebellious
 - b. religious
 - c. ridiculous

TRUE OR FALSE:

4. "For as I was passing through and considering the objects of your worship, I even found an altar with this inscription: to the unknown God." ACTS 17:22
TRUE OR FALSE
5. "God, who made the world, and everything in it, since He is Lord of heaven and earth, does not dwell in temples made with hands." ACTS 17:24
TRUE OR FALSE

UNDERLINE THE CORRECT ANSWER:

6. "And when they heard of the resurrection of the dead..." ACTS 17:32
- a. some mocked
 - b. others said, 'We will hear you again on this matter.'
 - c. all of the above

263. TO THE UNKNOWN GOD

(ACTS 17:16-34)

B T E M P L E S L O R D M C K
 E V C Q K E Y R B W V U B B B
 L A S L L A Y B K L S T D P K
 I R N E V A E H D A A B O I S
 E L S E L I T N E G T A G H M
 V W C K W V D E B P H B N S O
 E J H D K D J E W S E B O R A
 D U U D I Q J J K P N L B O T
 K N O I T C E R R U S E R W M
 S O E O J E I O K A M R M V Z
 U E N W O N K N U B C O U Z J
 H S L O D I P U A V C M L L S
 R E L I G I O U S K J E S U S
 P P C K S N T G E Q Z O P A M
 E T N Q U R V D T D L E M P B

ATHENS
 BABBLER
 BELIEVED
 GENTILES
 GOD
 HEAVEN

IDOLS
 JESUS
 JEWS
 LORD
 MOCKED
 PAUL

RELIGIOUS
 RESURRECTION
 TEMPLES
 UNKNOWN
 WORSHIP

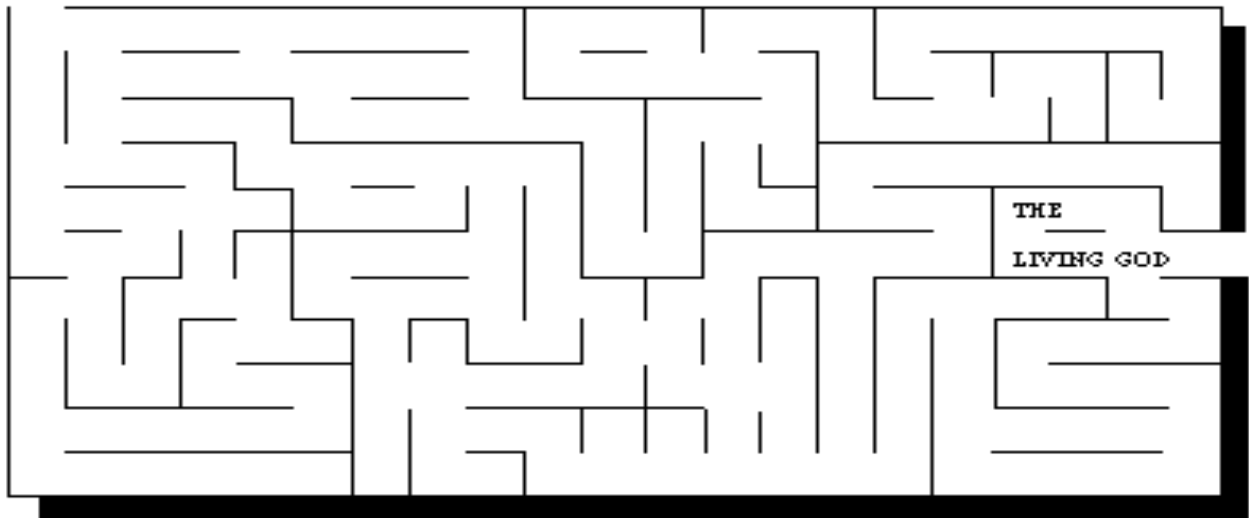

263. TO THE UNKNOWN GOD (ACTS 17:16-34)

MEMORY VERSE:

"God, who made the world and everything in it, since He is Lord of heaven and earth, does not dwell in temples made with hands." ACTS 17:24

FILL IN THE BLANK:

1. "Now while Paul waited for them at Athens, his spirit was provoked within him when he saw that the city was given over to _____." **ACTS 17:16**

TRUE OR FALSE:

2. "And they took him and brought him to the Areopagus, saying, 'May we know what this new doctrine is of which you speak?' " **ACTS 17:19**
TRUE OR FALSE

FILL IN THE BLANK:

3. "Then Paul stood in the midst of the Areopagus and said, 'Men of Athens, I perceive that in all things you are very _____.'" **ACTS 17:22**

TRUE OR FALSE:

4. "For as I was passing through and considering the objects of your worship, I even found an altar with this inscription: to the unknown God." **ACTS 17:22**
TRUE OR FALSE

FILL IN THE BLANK:

5. "God, who made the world, and everything in it, since He is Lord of heaven and earth, does not dwell in temples made with _____." **ACTS 17:24**

UNDERLINE THE CORRECT ANSWER:

6. "And when they heard of the resurrection of the dead..." **ACTS 17:32**
 - a. some mocked
 - b. others said, 'We will hear you again on this matter.'
 - c. all of the above

263. TO THE UNKNOWN GOD (ACTS 17:16-34)

U G P L J B D T S N U Q M U Y R H Z T K L E E M M M U I A C
 Y M K H W Z Q R I C N N G O T D B B P B C A S J C K B J D C
 Y Q S T Y Z C R A V U I O L W C A I Z I S E Z L U I W L P N
 R H P Y D N U W G S I S V W O R S H I P G Q P P R R V M U U
 F V P R J K R P W D E V S O U G U Z F F E U J O S K K P K K
 H V O L T O J E O C D L P U G S N F V W Y T H L J Q G B I S
 E L R O U B K L S C L U P I H Q K Z F L U V D T L Y P E B U
 L G B A N A S N A U U U T M B U N B H J W S C P S W E J R N
 M S O V A H P B F H R A W I E M O D N B I R E L B B A B Q E
 G N S C S F S B U R F R B B V T W K E B A E U N P C H C I S
 M B L A L V M C T E L D E R S J N B E K B T U R B Z K H J X
 B K K L P I J D O M Y D H C U Q U U M J E K S S N A H M L T
 P K W O U O T W M Q H W N W T L V Y J K L N Y E S K C B J I
 M O V Z T N A K J N B T J E B I A E Q U I B J L L R O I V L
 W J J M N H A I K Y O L Y G V J O E V M E Y G I P V G O D E
 N Q B F D I U E G M I A K T H A E N E B V Z A T H Z V V R I
 G S M M R U E P R A R O P K U T E J V Y E A K N L Y N M R A
 K P W O A A N I H E F A G W Q W I H V R D B R E Q E J T K K
 B M E Q C F Q Y G S L P K I T K S A L T C U B G U H L Q J Q
 Y B L S Z K B B D V Y I G U P M G V A T L E N A I Z D V S Y
 K B V Q E F E B V Y B A G S U S E J I S P D Y P C C R U F R
 P O D V M T N D B K D D P I L L J K L N A K N L C S Z G Q B
 U H D P D Q A P G W F Y S M O U P U R E I G M Y M G B B V T
 Y S Z B W H Y P C L B S O F J U Z O U H E C Q M R I Y D B P
 F S Z Q Q A Q Y Z W E M T O B G S Z U T Y M P T B F A O R K
 K R O J B U U F H W H U W E J C F B C A A N L F G L E N B Z
 T V W I I U Q O K Z T B I P H V B A Q C Q Q J H B B M Z I O
 G N H C T T T J K O L S H K T U X M N M A R D D I K B F U V
 E G Q T A T H W R A U E J J J B K Z R P O U D R V M Z N Q L
 Y D I C L D T S E K W J D F Y N M B U M Y M R S S I U B H C

ATHENS
BABBLER
BELIEVED
GENTILES
GOD
HEAVEN

IDOLS
JESUS
JEWS
LORD
MOCKED
PAUL

RELIGIOUS
RESURRECTION
TEMPLES
UNKNOWN
WORSHIP

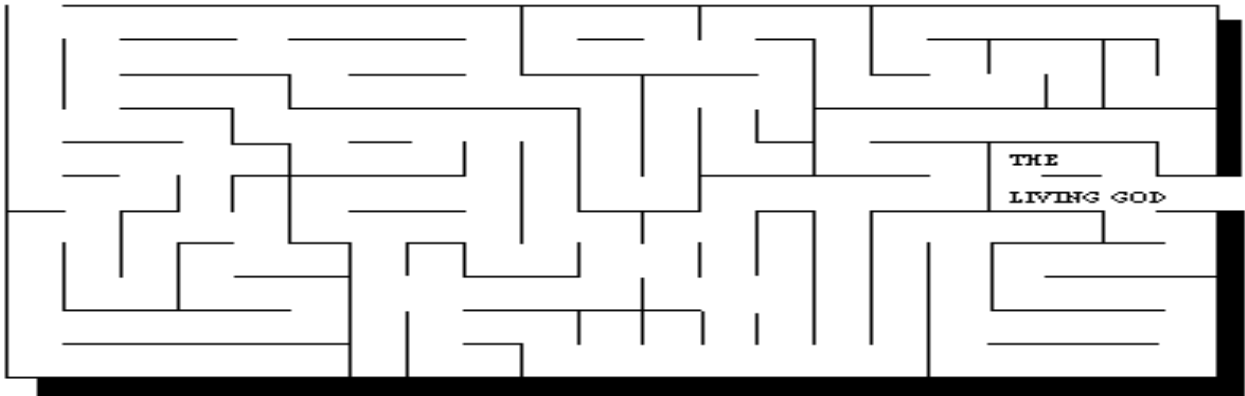

263. TO THE UNKNOWN GOD (ACTS 17:16-34)

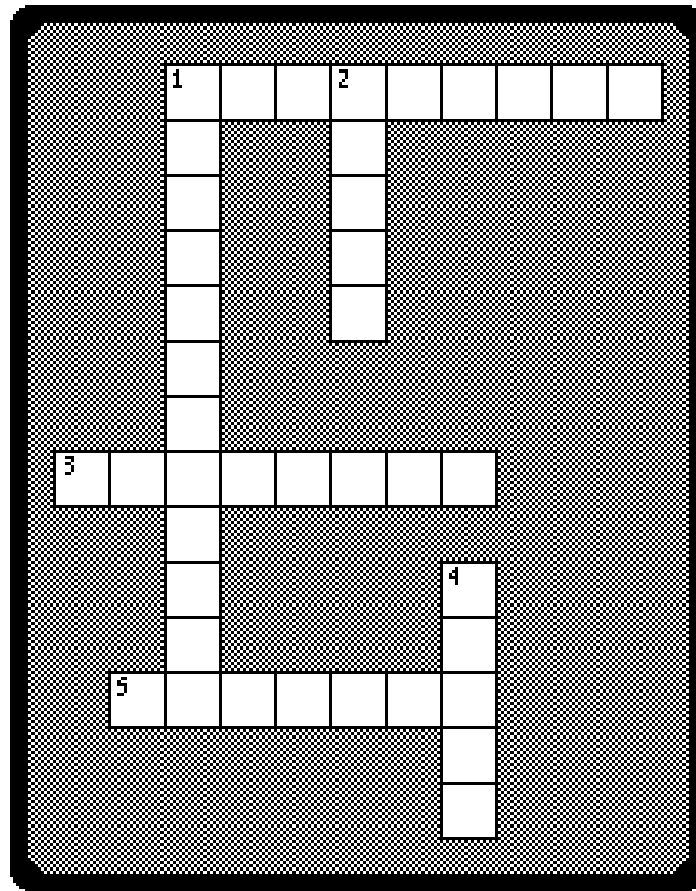

- 2 DOWN "Now while Paul waited for them at Athens, his spirit was provoked within him when he saw that the city was given over to ____." **ACTS 17:16**
- 3 ACROSS "And they took him and brought him to the Areopagus, saying, 'May we know what this new ____ is of which you speak?' " **ACTS 17:19**
- 1 ACROSS "Then Paul stood in the midst of the Areopagus and said, 'Men of Athens, I perceive that in all things you are very ____.'" **ACTS 17:22**
- 5 ACROSS "For as I was passing through and considering the objects of your worship, I even found an altar with this inscription: TO THE ____ GOD." **ACTS 17:22**
- 4 DOWN "God, who made the world, and everything in it, since He is Lord of heaven and earth, does not dwell in temples made with ____." **ACTS 17:24**
- 1 DOWN "And when they heard of the ____ of the dead, some mocked, others said, 'We will hear you again on this matter.' " **ACTS 17:32**

Bible Story 264

THE RIOT AT EPHESUS

Acts 19:11-41

264. THE RIOT AT EPHESUS (ACTS 19:11-41)



"And when they heard *these sayings*, they were full of wrath, and cried out, saying, Great *is* Diana of the Ephesians. And the whole city was filled with confusion: and having caught Gaius and Aristarchus, men of Macedonia, Paul's companions in travel, they rushed with one accord into the theatre."

ACTS 19:28-29

264. THE RIOT AT EPHEBUS

(ACTS 19:11-41)

MEMORY VERSE:

"So the word of the Lord grew mightily and prevailed." ACTS 19:20

TRUE OR FALSE:

1. "Now God worked unusual miracles at the hand of Paul." ACTS 19:11
TRUE OR FALSE
2. "So the word of the Lord grew mightily and prevailed." ACTS 19:20
TRUE OR FALSE
3. "And about that time there arose a great commotion about the Way." ACTS 19:23
TRUE OR FALSE

CIRCLE THE CORRECT WORDS:

4. "Moreover you see and hear that not only at Ephesus, but throughout almost all Asia, this Paul has persuaded and turned away many people, saying that they are not (**PLATES, GODS**) which are made with hands." ACTS 19:26
5. "And when they heard this, they were full of (**WRATH, JOY**) and cried out, saying, '**(GREAT, DEAD)** is Diana of the Ephesians!' " ACTS 19:28
6. "Then some of the (**PHARISEES, OFFICIALS**) of Asia, who were his friends, sent to him pleading that he would not venture into the theater." ACTS 19:31

TRUE OR FALSE:

7. "When the people found out that Paul was a Jew, all with one voice cried out, 'Great is Diana of the Ephesians!' " ACTS 19:34
TRUE OR FALSE

264. THE RIOT AT EPHESUS

(ACTS 19:11-41)

M Q V T H E W A Y Y R V Q L G
 G J E A E S D E F E N S E D O
 Q J M S G U V C D Y O J A O J
 W C N P W S E L P I C S I D M
 G B B W S T H E A T E R E H N
 B V R C O N F U S E D D G Y S
 W D E A S I A J N E W U A S R
 D I D J K J Q I K H H V E Q A
 I M N H O L O N S L J D T K N
 C O A N P A U L A E D C N D A
 P O B F I J V B U O H G B W I
 L F E G L T Y L G B S P K O D
 O U L T I M O T H Y R O E R M
 P D A I D B B L W T O I R C I
 D I E L P M E T K R A O R P U

ALEXANDER
 ASIA
 CONFUSED
 CROWD
 DEFENSE
 DIANA

DISCIPLES
 EPHESIANS
 GODDESS
 PAUL
 RIOT

TEMPLE
 THEATER
 THE WAY
 TIMOTHY
 UPROAR

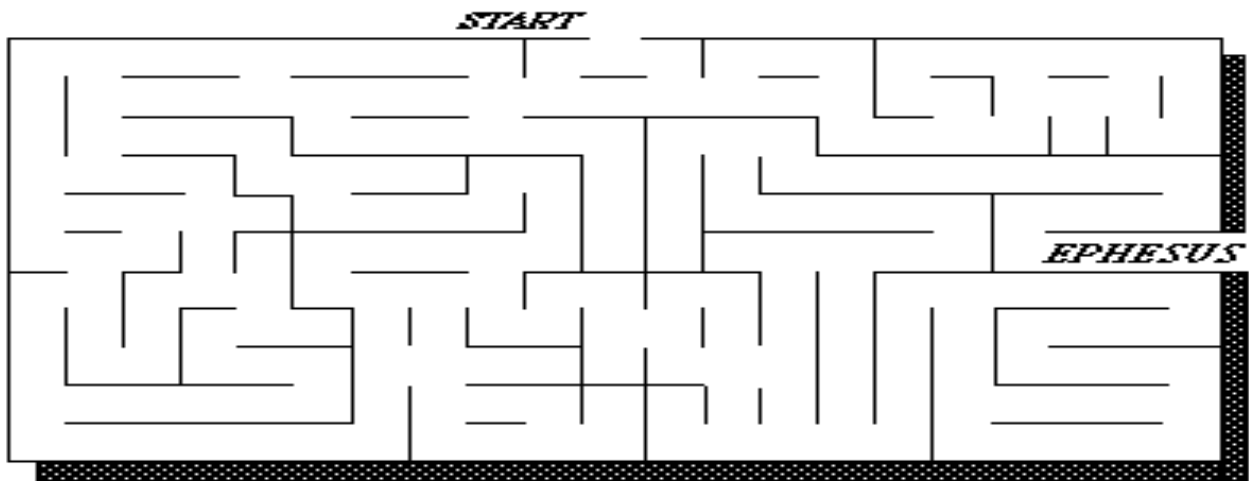

264. THE RIOT AT EPHEBUS (ACTS 19:11-41)

MEMORY VERSE:

"So the word of the Lord grew mightily and prevailed." ACTS 19:20

TRUE OR FALSE:

1. "Now God worked unusual miracles at the hand of Paul." ACTS 19:11
TRUE OR FALSE
2. "So the word of the Lord grew mightily and prevailed." ACTS 19:20
TRUE OR FALSE
3. "And about that time there arose a great commotion about the Way." ACTS 19:23
TRUE OR FALSE

FILL IN THE BLANKS:

4. "Moreover you see and hear that not only at Ephesus, but throughout almost all Asia, this Paul has persuaded and turned away many people, saying that they are not _____ which are made with hands." ACTS 19:26
5. "And when they heard this, they were full of _____ and cried out, saying, 'Great is Diana of the Ephesians!' " ACTS 19:28
6. "Then some of the _____ of Asia, who were his friends, sent to him pleading that he would not venture into the _____." ACTS 19:31

TRUE OR FALSE:

7. "When the people found out that Paul was a Jew, all with one voice cried out, 'Great is Diana of the Ephesians!' " ACTS 19:34
TRUE OR FALSE

264. THE RIOT AT EPHESUS

(ACTS 19:11-41)

M Q V T H E W A Y Y R V Q L G
 G J E A E S D E F E N S E D O
 Q J M S G U V C D Y O J A O J
 W C N P W S E L P I C S I D M
 G B B W S T H E A T E R E H N
 B V R C O N F U S E D D G Y S
 W D E A S I A J N E W U A S R
 D I D J K J Q I K H H V E Q A
 I M N H O L O N S L J D T K N
 C O A N P A U L A E D C N D A
 P O B F I J V B U O H G B W I
 L F E G L T Y L G B S P K O D
 O U L T I M O T H Y R O E R M
 P D A I D B B L W T O I R C I
 D I E L P M E T K R A O R P U

ALEXANDER
 ASIA
 CONFUSED
 CROWD
 DEFENSE
 DIANA

DISCIPLES
 EPHESIANS
 GODDESS
 PAUL
 RIOT

TEMPLE
 THEATER
 THEWAY
 TIMOTHY
 UPROAR

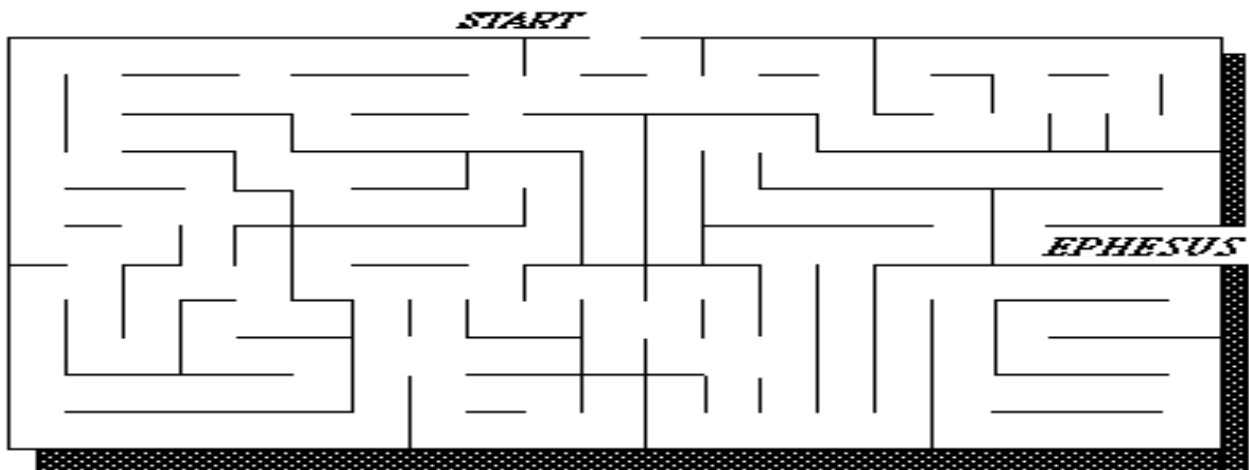

264. THE RIOT AT EPHESUS (ACTS 19:11-41)

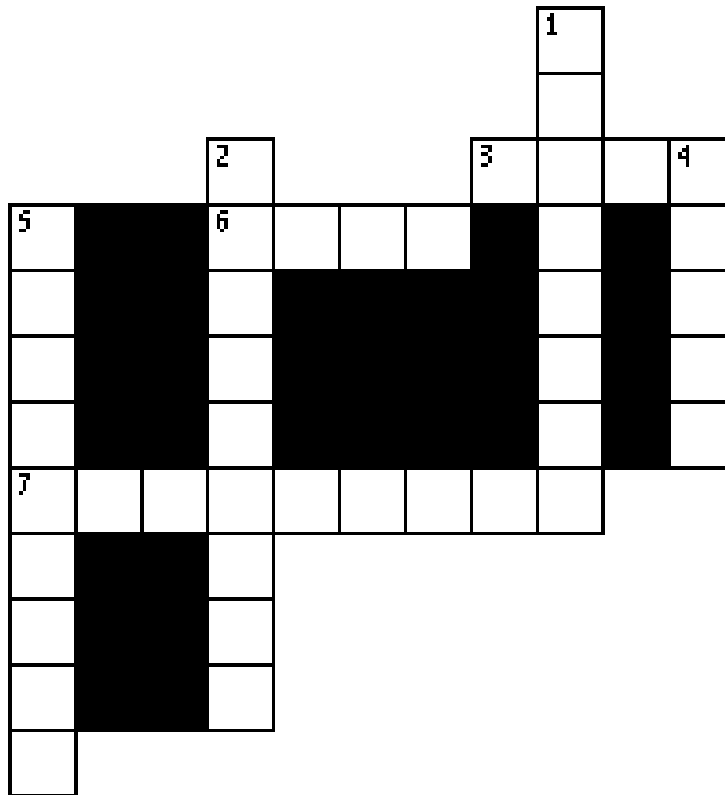

- 1 DOWN "Now God worked unusual _____ at the hand of Paul." **ACTS 19:11**
- 3 ACROSS "So the word of the Lord _____ mightily and prevailed." **ACTS 19:20**
- 5 DOWN "And about that time there arose a great _____ about the Way." **ACTS 19:23**
- 6 ACROSS "Moreover you see and hear that not only at Ephesus, but throughout almost all Asia, this _____ has persuaded and turned away many people, saying that they are not gods which are made with hands." **ACTS 19:26**
- 4 DOWN "And when they heard this, they were full of _____ and cried out, saying, 'Great is Diana of the Ephesians!' " **ACTS 19:28**
- 7 ACROSS "Then some of the _____ of Asia, who were his friends, sent to him pleading that he would not venture into the theater." **ACTS 19:31**
- 2 DOWN "When the people found out that Paul was a Jew, all with one voice cried out, 'Great is Diana of the _____!' " **ACTS 19:34**

Bible Story 265

**PAUL
IS ARRESTED
IN THE TEMPLE**

ACTS 21:26-22:29

265. PAUL IS ARRESTED IN THE TEMPLE (ACTS 21:26-22:29)

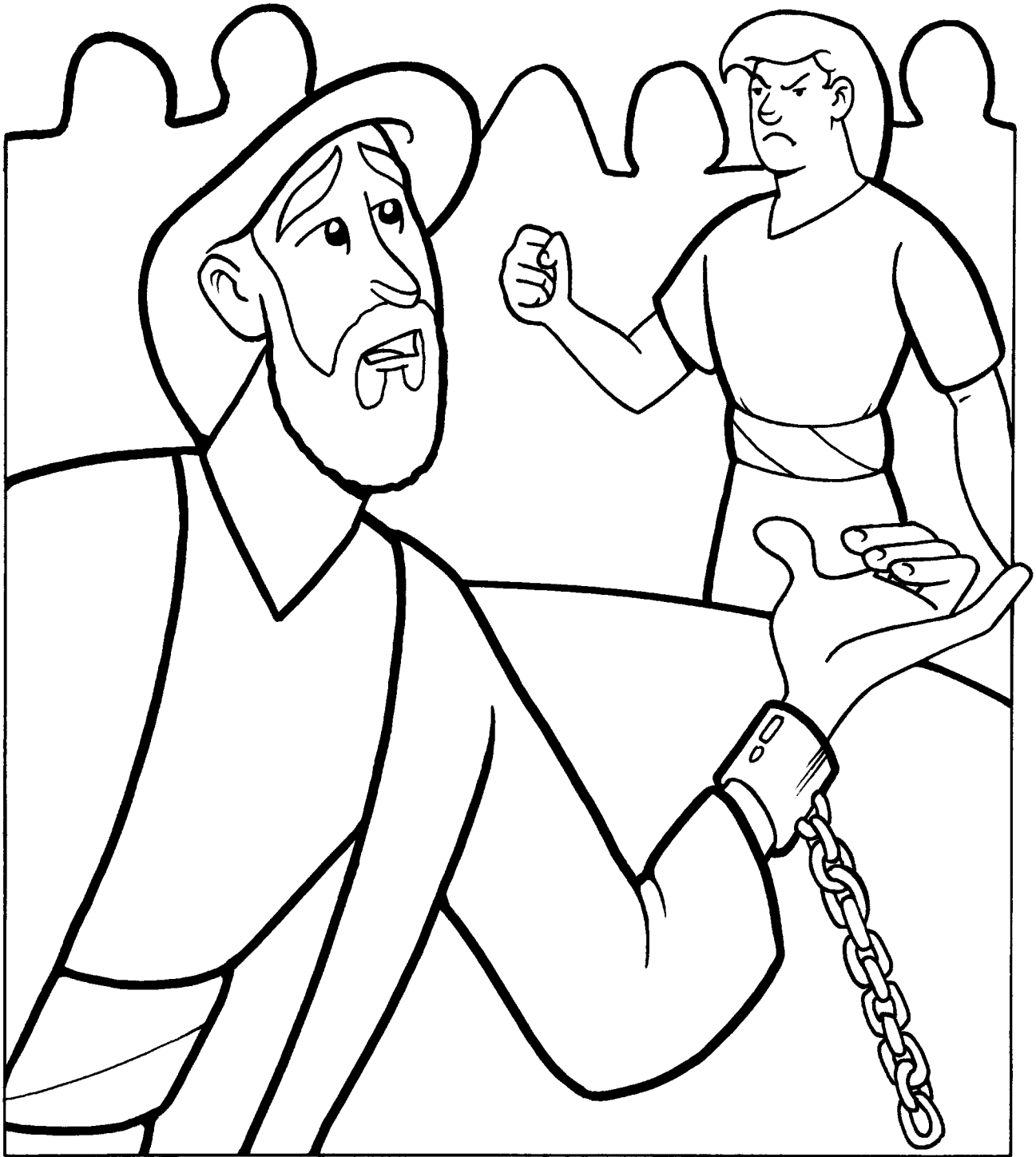

"And all the city was moved, and the people ran together: and they took Paul, and drew him out of the temple: and forthwith the doors were shut."

ACTS 21:30

265. PAUL IS ARRESTED IN THE TEMPLE

(ACTS 21:26-22:29)

MEMORY VERSE:

"Blessed are you when they revile and persecute you, and say all kinds of evil against you falsely for My sake. Rejoice and be exceedingly glad, for great is your reward in heaven, for so they persecuted the prophets who were before you." MATTHEW 5:10-11

TRUE OR FALSE:

1. "Paul took the men, and the next day, having been purified with them, entered the temple." **ACTS 21:26**
TRUE OR FALSE
2. "The Jews from Asia, seeing him in the temple, stirred up the whole crowd and laid hands on him."
ACTS 21:27
TRUE OR FALSE
3. And all the city was happy; and the people ran to welcome Paul to the temple. **ACTS 21:30**
TRUE OR FALSE

CIRCLE THE CORRECT WORDS:

4. "Now as they were seeking to (**KICK, KILL**) him, news came to the commander of the garrison that all Jerusalem was in an uproar." **ACTS 21:31**
5. "He immediately took soldiers and centurions, and ran down to them. And when they saw the commander and the soldiers, they (**STOPPED, STARTED**) beating Paul." **ACTS 21:32**
6. "Paul said, 'I am a Jew from Tarsus, in Cilicia, a citizen of no mean city; and I implore you, permit me to (**LISTEN, SPEAK**) to the people.'" **ACTS 21:39**

TRUE OR FALSE:

7. "And they listened to him until this word, and then they raised their voices and said, 'Away with such a fellow from the earth, for he is not fit to live!' " **ACTS 22:22**
TRUE OR FALSE
8. "As they bound him with thongs, Paul said to the centurion who stood by, 'Is it lawful for you to scourge a man who is a Roman, and uncondemned?' " **ACTS 22:25**
TRUE OR FALSE

CIRCLE THE CORRECT WORD:

9. "Then immediately those who were about to examine him withdrew from him; and the commander was also (**UPSET, AFRAID**) after he found out that he was a Roman, and because he had bound him." **ACTS 22:29**

265. PAUL IS ARRESTED IN THE TEMPLE (ACTS 21:26-22:29)

T B E A T I N G G L S N C K O
 E G R E E K S T F A M O I F A
 S L H D W A J E W S C B T S T
 T W U D K V Y V K P Z O I R M
 I J R E D N A M M O C F Z E Z
 M U E O I D Y R D P L F E I J
 O O C J E S U S B A U E N D E
 N E N K J Q D F K B T R P L L
 Y D E T U C E S R E P I M O P
 P P N A M O R E K V M N C S M
 E T D E I F I R U P O G C K E
 V C Q Q S E J J A Q L U A S T
 C E N T U R I O N S E U V S S
 A S L K U N I O T D M L U A P
 R C K L E R P U W V B L Z M M

BEATING
 CENTURIONS
 CITIZEN
 COMMANDER
 GREEKS
 JESUS

JEWS
 OFFERING
 PAUL
 PERSECUTED
 PURIFIED

ROMAN
 SAUL
 SOLDIERS
 TEMPLE
 TESTIMONY

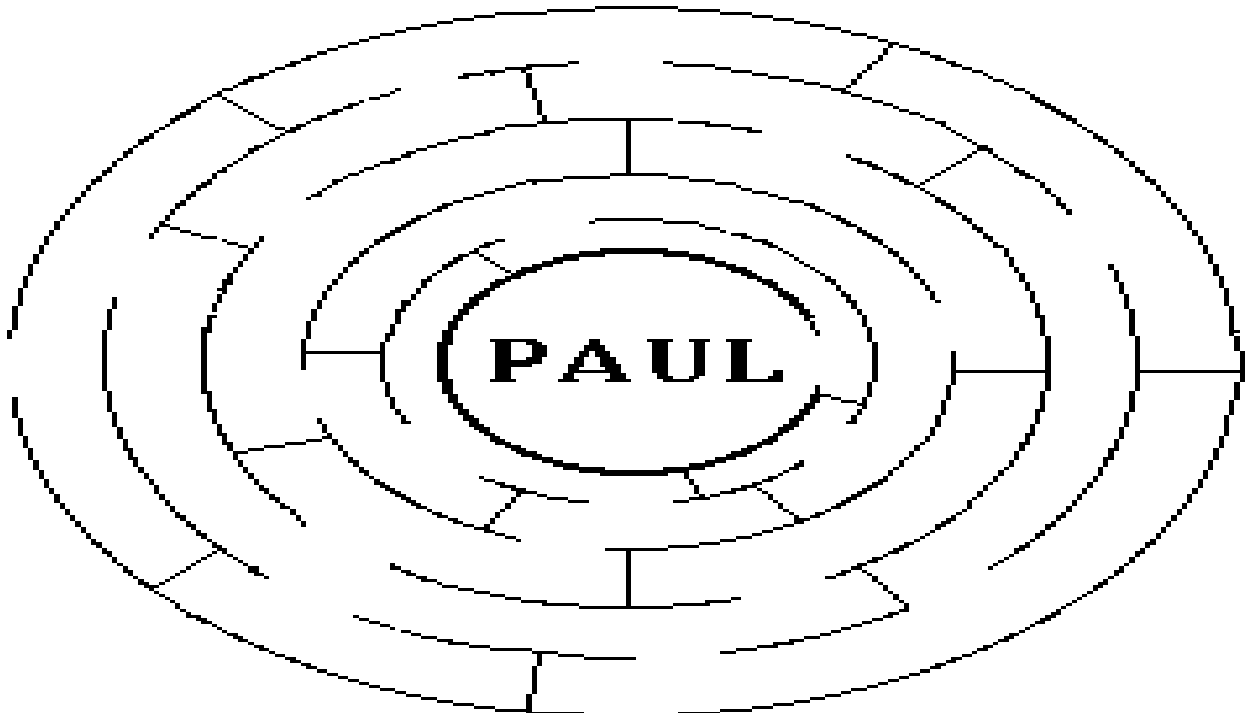

265. PAUL IS ARRESTED IN THE TEMPLE

(ACTS 21:26-22:29)

MEMORY VERSE:

"Blessed are you when they revile and persecute you, and say all kinds of evil against you falsely for My sake. Rejoice and be exceedingly glad, for great is your reward in heaven, for so they persecuted the prophets who were before you." MATTHEW 5:10-11

FILL IN THE BLANK:

1. "Paul took the men, and the next day, having been purified with them, entered the _____."
ACTS 21:26

TRUE OR FALSE:

2. "The Jews from Asia, seeing him in the temple, stirred up the whole crowd and laid hands on him." ACTS 21:27
TRUE OR FALSE
3. And all the city was happy; and the people ran to welcome Paul to the temple. ACTS 21:30
TRUE OR FALSE

FILL IN THE BLANKS:

4. "Now as they were seeking to _____ him, news came to the commander of the garrison that all Jerusalem was in an uproar." ACTS 21:31
5. "He immediately took soldiers and centurions, and ran down to them. And when they saw the commander and the soldiers, they stopped _____ Paul." ACTS 21:32
6. "Paul said, 'I am a Jew from Tarsus, in Cilicia, a citizen of no mean city; and I implore you, permit me to _____ to the people.'" ACTS 21:39

TRUE OR FALSE:

7. "And they listened to him until this word, and then they raised their voices and said, 'Away with such a fellow from the earth, for he is not fit to live!' " ACTS 22:22
TRUE OR FALSE
8. "As they bound him with thongs, Paul said to the centurion who stood by, 'Is it lawful for you to scourge a man who is a Roman, and uncondemned?' " ACTS 22:25
TRUE OR FALSE

FILL IN THE BLANKS:

9. "Then immediately those who were about to examine him withdrew from him; and the commander was also _____ after he found out that he was a Roman, and because he had _____ him."
ACTS 22:29

265. PAUL IS ARRESTED IN THE TEMPLE (ACTS 21:26-22:29)

P H Z Q Q Q A B J M L A W R B T F Z R C A Z J A B C H H I E
 U S Z J B H Y B K Q Y D B W H W B B U M Q A G P N Z K M J S
 Y S O I I A Q P G N H D H G U K B B A U P A B A L S A H B L B
 F R W C T U U P H D S W J S O L D I E R S U B Y L K C I J T
 K V H T A U P Y G C E T Y T Q M K M C M O E R M P R V V M R R L
 T N Q S L T Q E O Y X I K K T L M Z Q L Y D B T H V V M R R E
 G G I C K T T U R M O L F W P S A U L C N A M O R Z N T R E T
 E B L J B E R F D S I A P I L U Z B N S E K N F E L P M E T
 Y P H W Z G E O V A E O G I R G B T R G A G N I R E F F O I
 G K T Y E D H R B S R C K U J U I P U E E G Y H L Y J Q K A
 M S Y J Z D T J G V F A U M B C P Z K Y T C N D Q E L V J K
 Q P O T N Q T W G Y Y P G T J V Z F B U E M M R U H D U S Q
 H P A N K C R S C B B A P F E U F V I W S N G E I Z R G F Y
 V R V A O J E S U S D D S O H D Z F F I T N Q D C C Z B Q R
 V B C S B U R S Z W F Y O E T B B H W A I Q P N C S B D V B
 G O A L H J W W H L B S T P J N D N L T M R L A M G Y O B T
 S S C P F K P E C W E M W K Y H K E A C O U J M R I A N R P
 N L L I V S N J K E H U I J R B B E J L N M D M X F E Z B K
 B K O U T M K S K W N B H F D A B E B P Y E D O G L M F I Z
 K W Z T I I B I R Z T T J Y C U B M B A Q S R C B B B N U O
 K V M N O J Z A E O L S U T G V Y J K G U Z M R I K Z B Q V
 O J F D N T C E N A U E D R S A E Q J N T P J S V M U A H L
 J X M R H A D G N K W J U W I E E V K I V J L M S I I D C C
 Q W Q A I A W W C U Q M O U Q O J E U A S H P C M U J P C Y
 S E S Z U U K A V N N G L G U I N V M T E D O U K B L U N Y
 P L Q E A E I F C U I O O H M S A V B E T C L R I W M K U P
 M V V M F N E U C D S V U B J G V L Y B K U T S R V P I K D
 B P A U L Q P T H L V S I V Q J K A R I N U P J K K B B S D
 B D P D F B I O R U U P I S L P U I T E B S N L Q G E R U A
 O D B W T N Y M E F U T B U J Z O L T Y Y Y R P Y C Q N W

BEATING
 JEWS
 TESTIMONY
 CITIZEN
 COMMANDER
 GREEKS

JESUS
 SAUL
 OFFERING
 PAUL
 PERSECUTED
 PURIFIED

ROMAN
 CENTURION
 SCOURGE
 SOLDIERS
 TEMPLE

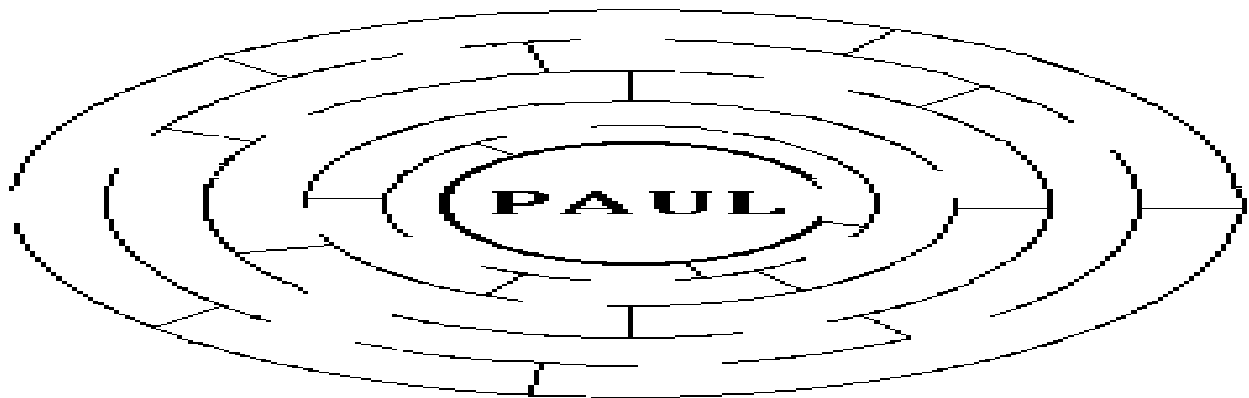

265. PAUL IS ARRESTED IN THE TEMPLE

(ACTS 21:26-22:29)

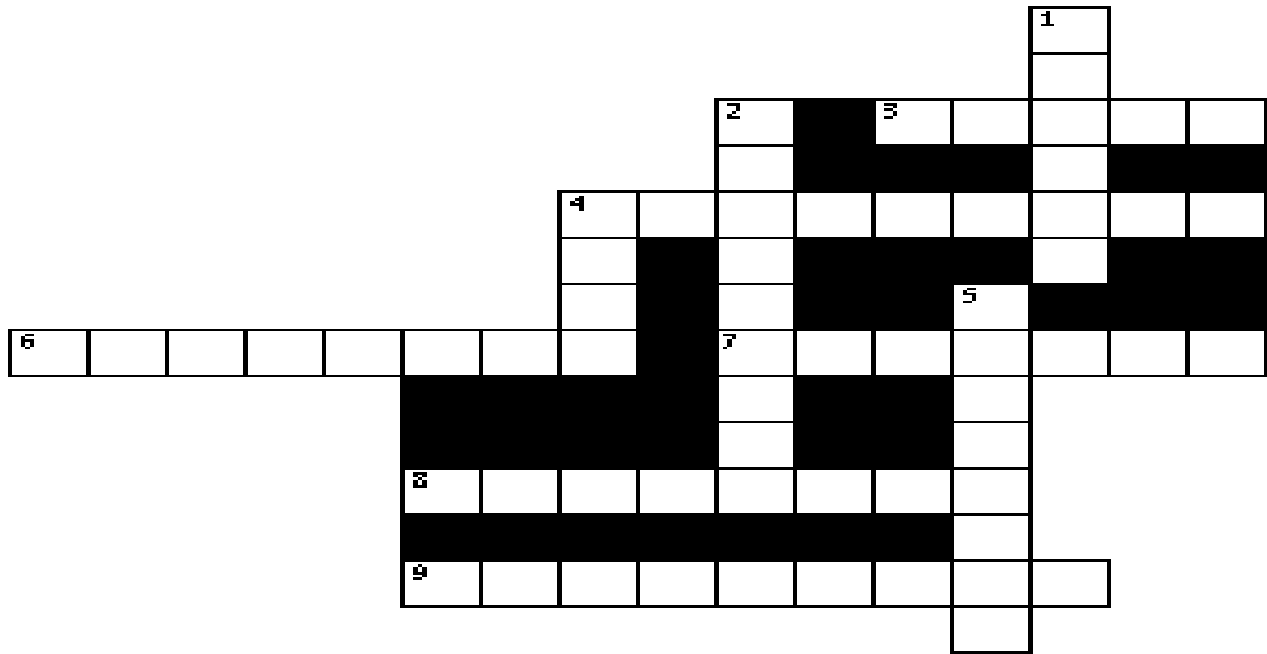

- 2 DOWN "Blessed are you when they revile and _____ you, and say all kinds of evil against you falsely for My sake." **MATTHEW 5:10**
- 1 DOWN "Paul took the men, and the next day, having been purified with them, entered the _____." **ACTS 21:26**
- 4 DOWN "The _____ from Asia, seeing him in the temple, stirred up the whole crowd and laid hands on him." **ACTS 21:27**
- 9 ACROSS "And all the city was _____." **ACTS 21:30**
- 4 ACROSS "Now as they were seeking to kill him, news came to the commander of the garrison that all _____ was in an uproar." **ACTS 21:31**
- 6 ACROSS "He immediately took soldiers and centurions, and ran down to them. And when they saw the commander and the _____, they stopped beating Paul." **ACTS 21:32**
- 7 ACROSS "Paul said, 'I am a Jew from Tarsus, in Cilicia, a _____ of no mean city; and I implore you, permit me to speak to the people.'" **ACTS 21:39**
- 8 ACROSS "And they _____ to him until this word, and then they raised their voices and said, 'Away with such a fellow from the earth, for he is not fit to live!' " **ACTS 22:22**
- 3 ACROSS "As they bound him with thongs, Paul said to the centurion who stood by, 'Is it lawful for you to scourge a man who is a _____, and uncondemned?' " **ACTS 22:25**
- 5 DOWN "Then immediately those who were about to examine him _____ from him; and the commander was also afraid after he found out that he was a Roman, and because he had bound him." **ACTS 22:29**

Bible Story 266

PAUL IS SENT TO FELIX

ACTS 23:23-24:27



"Paul is sent to Felix."
Acts 23:23-24:27

266. PAUL IS SENT TO FELIX (ACTS 23:23-24:27)

MEMORY VERSE:

"But watch out for yourselves, for they will deliver you up to councils, and you will be beaten in the synagogues. And you will be brought before rulers and kings for My sake, for a testimony to them." MARK 13:9

TRUE OR FALSE:

1. "Then the soldiers, as they were commanded, took Paul and brought him by night to Antipatris." **ACTS 23:31**
TRUE OR FALSE
2. "When they came to Caesarea and had delivered the letter to the governor, they also presented Paul to him." **ACTS 23:33**
TRUE OR FALSE
3. "Now after five days Ananias the high priest came down with the elders and a certain orator named Tertullus. These gave evidence to the governor against Paul." **ACTS 24:1**
TRUE OR FALSE

CIRCLE THE CORRECT WORDS:

4. "For we have found this man a (**CRIMINAL**, **PLAGUE**), a creator of dissension among all the Jews throughout the world, and a ringleader of the sect of the Nazarenes." **ACTS 24:5**
5. "For this I confess to you, that according to the Way which they call a sect, so I worship the God of my fathers, believing (**ALL**, **NO**) things which are written in the Law and the Prophets." **ACTS 24:14**

TRUE OR FALSE:

6. "Now as he reasoned about righteousness, self-control, and the judgment to come, Felix was afraid and answered, 'Go away for now; when I have a convenient time I will call for you.'" **ACTS 24:25**
TRUE OR FALSE
7. But after two years Porcius Festus succeeded Felix; and Felix, wanting to do the Jews a favor, let Paul go. **ACTS 24:27**
TRUE OR FALSE

266. PAUL IS SENT TO FELIX

(ACTS 23:23-24:27)

S	A	C	C	U	S	E	R	S	E	T	G	A	B	F
P	H	S	K	R	T	C	D	K	N	W	F	T	V	E
E	Q	J	S	L	C	N	D	I	R	O	K	W	A	L
A	O	H	U	W	S	Q	O	J	Y	Y	P	L	I	I
R	A	N	E	M	E	S	R	O	H	E	R	A	R	X
M	W	P	A	U	L	W	K	S	Y	A	O	P	A	C
E	V	Q	H	J	C	A	Q	U	D	R	P	S	S	A
N	M	O	P	U	H	L	K	E	J	S	H	A	E	L
V	S	N	O	I	R	U	T	N	E	C	E	I	A	L
T	F	E	E	O	U	L	L	A	I	R	T	N	C	I
W	S	R	O	N	R	E	V	O	G	F	S	A	Q	S
H	W	W	V	E	F	A	I	T	H	E	D	N	D	U
S	O	L	D	I	E	R	S	V	P	J	B	A	V	R
P	U	E	A	P	E	K	W	D	T	O	K	P	S	D
J	D	B	D	N	U	O	B	Q	V	U	K	A	M	Z

ACCUSERS
ANANIAS
BOUND
CAESARIA
CENTURIONS
DRUSILLA

FAITH
FELIX
GOVERNOR
HORSEMEN
LAW

PAUL
PROPHETS
SOLDIERS
SPEARMEN
TWO YEARS

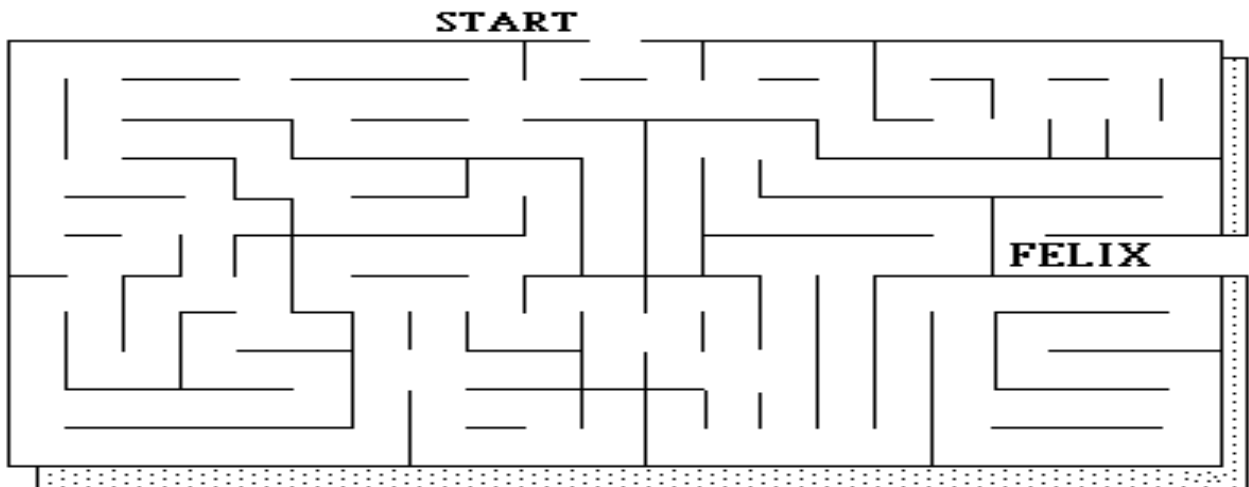

266. PAUL IS SENT TO FELIX (ACTS 23:23-24:27)

MEMORY VERSE:

"But watch out for yourselves, for they will deliver you up to councils, and you will be beaten in the synagogues. And you will be brought before rulers and kings for My sake, for a testimony to them." MARK 13:9

TRUE OR FALSE:

1. "Then the soldiers, as they were commanded, took Paul and brought him by night to Antipatris." **ACTS 23:31**
TRUE OR FALSE
2. "When they came to Caesarea and had delivered the letter to the governor, they also presented Paul to him." **ACTS 23:33**
TRUE OR FALSE

FILL IN THE BLANKS:

3. "Now after five days Ananias the high priest came down with the elders and a certain orator named Tertullus. These gave _____ to the governor against Paul." **ACTS 24:1**
4. "For we have found this man a _____, a creator of dissension among all the Jews throughout the world, and a ringleader of the sect of the Nazarenes." **ACTS 24:5**
5. "For this I confess to you, that according to the Way which they call a sect, so I worship the God of my fathers, believing _____ things which are written in the Law and the Prophets." **ACTS 24:14**

TRUE OR FALSE:

6. "Now as he reasoned about righteousness, self-control, and the judgment to come, Felix was afraid and answered, 'Go away for now; when I have a convenient time I will call for you.'" **ACTS 24:25**
TRUE OR FALSE
7. But after two years Porcius Festus succeeded Felix; and Felix, wanting to do the Jews a favor, let Paul go. **ACTS 24:27**
TRUE OR FALSE

266. PAUL IS SENT TO FELIX

(ACTS 23:23-24:27)

O J M R N T C F E Z F P K U L U M M U M Y Z G L L R O M R I
 J B Q A H A D U N O B A G M J G Z Z U P A A A Y P V V T K A
 Q W S Z I A W T C A E D P F B C B B C M Q B K M H Z N Q J K
 S E Q E U U K O V N P Y S T W O Y E A R S U R T L Y J V S Q
 P L V M A E R M C R E S O O J V I T Q L A E B F Q E L U F Y
 M V P S F N I E O K H M T E H U Z P N C O D N H U H D G Q R
 B D B D A Q E P S U T M R P T F A I T H D E G D U J R B V B
 B D Q W F I H J C U L U W A J B F Z R S Y K Y D I Z Z D B T
 O Z J Q T E N K H N R B I K E N Z F U G E N E M E S R O H P
 H Z I B T B P A R U U R H J Y P B V K E A G N R C C B O R K
 S O C S Q N I G N D W S E F R H S F B Y D C M S C S Y N B Z
 S W T I H A Y H E A Q E J C D B D H I U R M Q A M G A Z I O
 R H L A W Y B G M L N J S Y T A K N F W U N P I R I E F U V
 V Q C T A F E S T U S M D R C I B E W I S Q L R B F M N Q L
 N I J A U Q B D Q U I G U T E U O E L A I R J A G L B B H C
 G L W L U U P N N F S O O W G S U N J C L U D S B B Z A C Y
 D H G B T Q P U C L V V L U S V U M B L L M D E I K U D C Y
 P T Y O T T Y O Y E U S O G Q A Y C B P A E R A V M I P N P
 K Y J Z V H F B M Y N P U H U E E J C A E S M C S I J U U D
 S O T Z D E O D A H U T I B M I E Q K A Q Z J M M U L K K D
 P A N N D T R V S B A T U V J S J V J S U P L C K B M I S A
 P V A K Q T J N V O D W I R Q G A E K R T J P U I W P B U W
 R C S O C R W B O I D B B S I J V V U E V H O R R V B R N Z
 B A L B U R S G Y R W H R U L O K V M I S D L S K K E Q E C
 O L P H J W S C L R T J W B J P N L B D E C T J Q G C I S P
 S O U F K P I Z K U L Y G H T Z U S Y L T U P L Y P H J B Y
 L Z T V S N A H W F A K T U W F O A R O K U N P C H M L T E
 K F E L I X G K L Y A P K Q K B Z I T S N S R B Z K B J I J
 W M N I M K W K W B O P W T M B B L T I B Y A N A H I V L R
 V F D O J B A R W D A G I P L K A R C E Y J P S K C V R E L

ACCUSERS
 ANANIAS
 BOUND
 CAESARIA
 CENTURIONS
 DRUSILLA
 FAITH

FELIX
 FESTUS
 GOVERNOR
 HORSEMEN
 JUDGED
 LAW

PAUL
 PROPHETS
 RESURRECTION
 SOLDIERS
 SPEARMEN
 TWO YEARS

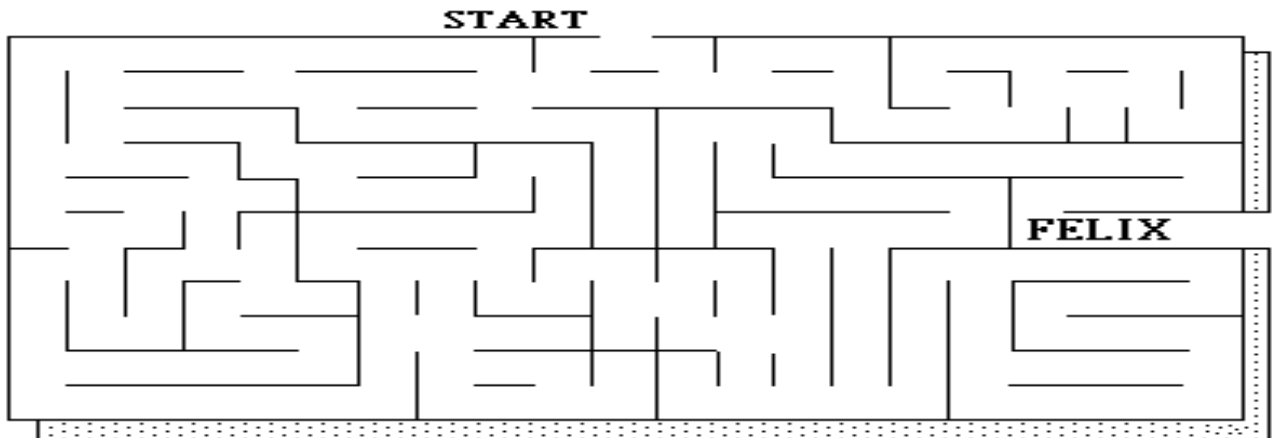

266. PAUL IS SENT TO FELIX (ACTS 23:23-24:27)

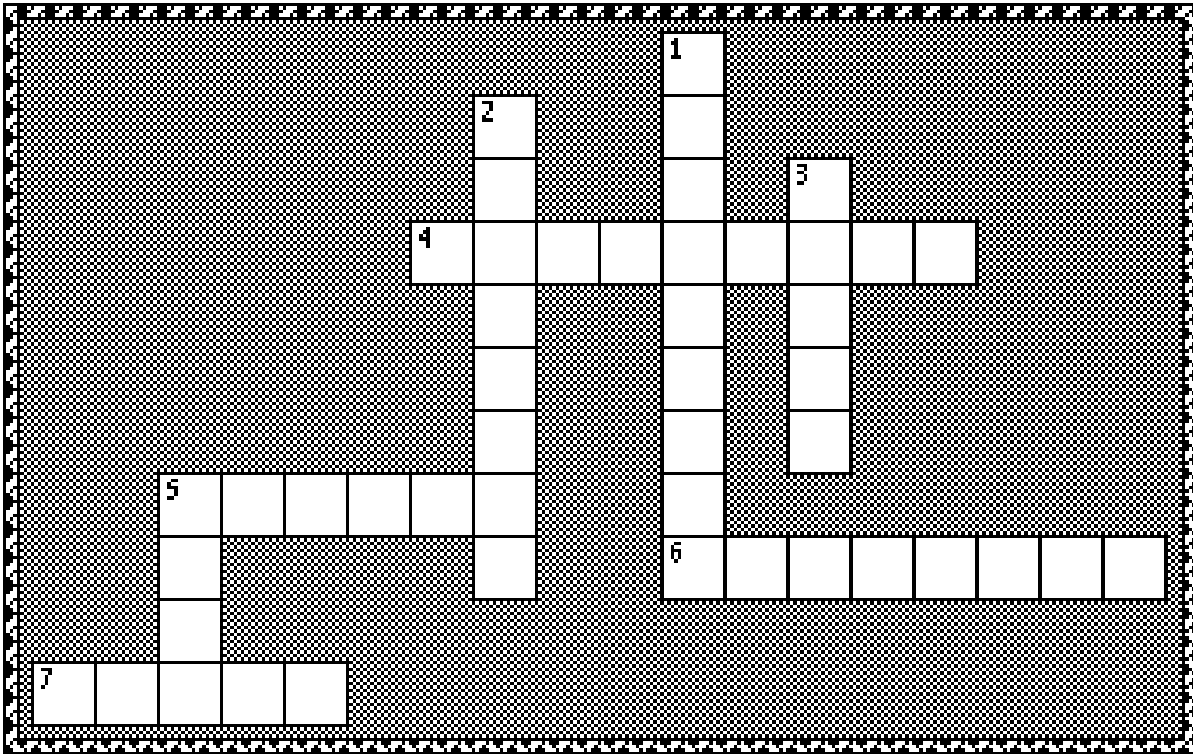

- 4 ACROSS "But watch out for yourselves, for they will deliver you up to councils, and you will be beaten in the synagogues. And you will be brought before rulers and kings for My sake, for a _____ to them." **MARK 13:9**
- 5 DOWN "Then the soldiers, as they were commanded, took _____ and brought him by night to Antipatris." **ACTS 23:31**
- 2 DOWN "When they came to _____ and had delivered the letter to the governor, they also presented Paul to him." **ACTS 23:33**
- 6 ACROSS "Now after five days Ananias the high priest came down with the elders and a certain orator named Tertullus. These gave evidence to the _____ against Paul." **ACTS 24:1**
- 5 ACROSS "For we have found this man a _____, a creator of dissension among all the Jews throughout the world, and a ringleader of the sect of the Nazarenes." **ACTS 24:5**
- 1 DOWN "For this I confess to you, that according to the Way which they call a sect, so I worship the God of my fathers, _____ all things which are written in the Law and the Prophets." **ACTS 24:14**
- 7 ACROSS "Now as he reasoned about righteousness, self-control, and the judgment to come, _____ was afraid and answered, 'Go away for now; when I have a convenient time I will call for you.'" **ACTS 24:25**
- 3 DOWN "But after two years Porcius Festus succeeded Felix; and Felix, wanting to do the Jews a favor, left Paul _____." **ACTS 24:27**

Bible Story 267

**PAUL
GOES BEFORE
AGRIPPA**

ACTS 25:13-26:32



"Paul is brought before King Agrippa."
Acts 25:13–26:32

267. PAUL GOES BEFORE AGRIPPA

(ACTS 25:13-26:32)

MEMORY VERSE:

"Then Agrippa said to Paul, 'You almost persuade me to become a Christian.' "
ACTS 26:28

TRUE OR FALSE:

1. "And after some days King Agrippa and Bernice came to Caesarea to greet Festus."
ACTS 25:13

TRUE OR FALSE

2. "So the next day, when Agrippa and Bernice had come with great pomp, and had entered the auditorium with the commanders and the prominent men of the city, at Festus' command Paul was brought in." ACTS 25:23

TRUE OR FALSE

CIRCLE THE CORRECT WORDS:

3. "Then Agrippa said to Paul, 'You are permitted to speak for (YOURSELF, ANOTHER).' So Paul stretched out his hand and answered for himself." ACTS 26:1
4. "Now as he thus made his defense, Festus said with a loud voice, 'Paul, you are beside yourself! Much learning is driving you (SAD, MAD)!'" ACTS 26:24
5. "But he said, 'I am not mad, most noble Festus, but speak the words of (TRUTH, LIES) and reason.'" ACTS 26:25

TRUE OR FALSE:

6. "Then Agrippa said to Paul, 'You almost persuade me to become a Christian.'" ACTS 26:28

TRUE OR FALSE

CIRCLE THE CORRECT WORDS:

7. "And Paul said, 'I would to God that not only you, but also all who hear me today, might become both almost and altogether such as I am, except for these (STRIPES, CHAINS).'" ACTS 26:29
8. "Then Agrippa said to Festus, 'This man might have been set (ASIDE, FREE) if he had not appealed to Caesar.'" ACTS 26:32

267. PAUL GOES BEFORE AGRIPPA

(ACTS 25:13-26:32)

D	B	E	R	N	I	C	E	J	U	L	N	P	U	J
A	E	J	T	P	F	Q	U	U	E	F	R	E	E	J
M	L	F	P	J	S	O	H	O	C	W	R	T	A	S
A	I	A	L	H	W	E	P	E	N	K	A	V	I	U
S	E	D	E	L	A	E	P	P	A	I	G	R	R	S
C	V	H	J	Q	U	W	E	P	Q	J	R	F	A	K
U	E	A	C	O	D	E	V	T	L	S	I	S	S	S
S	K	H	V	A	S	B	A	C	B	U	P	U	E	N
O	N	O	I	T	A	S	U	C	C	A	P	T	A	I
I	P	B	T	W	J	K	R	S	D	E	A	S	C	A
T	Z	Y	F	I	T	S	E	T	D	A	Y	E	G	H
E	Y	Y	W	V	K	I	N	G	O	V	Y	F	F	C
C	H	R	I	S	T	I	A	N	K	D	D	E	K	K
J	Y	N	H	M	H	S	L	C	Q	Q	J	J	D	A
K	O	J	L	U	A	P	W	H	K	E	I	O	B	T

ACCUSATION
 AGRIPPA
 APPEALED
 BELIEVE
 BERNICE

CAESARIA
 CHAINS
 CHRISTIAN
 DAMASCUS
 FESTUS

FREE
 JESUS
 KING
 PAUL
 TESTIFY



267. PAUL GOES BEFORE AGRIPPA

(ACTS 25:13-26:32)

MEMORY VERSE:

"Then Agrippa said to Paul, 'You almost persuade me to become a Christian.' "
ACTS 26:28

TRUE OR FALSE:

1. "And after some days King Agrippa and Bernice came to Caesarea to greet Festus."
ACTS 25:13

TRUE OR FALSE

2. "So the next day, when Agrippa and Bernice had come with great pomp, and had entered the auditorium with the commanders and the prominent men of the city, at Festus' command Paul was brought in." ACTS 25:23

TRUE OR FALSE

FILL IN THE BLANKS:

3. "Then Agrippa said to Paul, 'You are permitted to speak for _____.' So Paul stretched out his hand and answered for himself." ACTS 26:1
4. "Now as he thus made his defense, Festus said with a loud voice, 'Paul, you are beside yourself! Much learning is driving you _____!' " ACTS 26:24
5. "But he said, 'I am not mad, most noble Festus, but speak the words of _____ and reason.' " ACTS 26:25

TRUE OR FALSE:

6. "Then Agrippa said to Paul, 'You almost persuade me to become a Christian.' " ACTS 26:28

TRUE OR FALSE

FILL IN THE BLANKS:

7. "And Paul said, 'I would to God that not only you, but also all who hear me today, might become both almost and altogether such as I am, except for these _____.' "
ACTS 26:29
8. "Then Agrippa said to Festus, 'This man might have been set _____ if he had not appealed to Caesar.' " ACTS 26:32

267. PAUL GOES BEFORE AGRIPPA

(ACTS 25:13-26:32)

C F S Z J I T T S E K W J D F Y N Z P B L Y M R S S I I D N
 E K R O I T T T S N U Q M U Y R H B Z I C E E M M M U J P U
 U T V W C A D R I C N N G O T D B I F F S A S J C K B L U K
 B G N H G L D R A E F I O C A E S A R I A E Z L U I W M K S
 M E G N T B A W G R C S V L W C A Z V W G Q P P R R V P I U
 K Y I Q C Z Q C E V U I S O U G G F F L E U J O S K K B B N
 U K D I J Z C E C C D V N U G S R Z H J Y T H L J Q G E R E
 Y G P L W N U P W U L U P R H Q I B N B U V D T L U A P Q S
 Y M K H Y K J N A C S U T I E U P D E B W E V E I L E B I B
 R Q S T J O K K F H U A W I B B P K E K I S C P L Y P C J T
 F H P Y T B S B U R F A T B V M A B M J A E U N P C H H L I
 H V P O N H M C T E L D B I S J A U J K P T U S B Z K M J L
 E V R A A F J D O M Y D S R O Q U Y Q U P K S U N A H B V E
 L G B V S V T W M Q H W H N U N V E V M E N Y C S K C I R I
 M S O C L I A K J N B T J W I L A E E B A B J S L R O V R A
 G N S A P O A I K Y O L Y G B A E J V Y L Y G A P V V M K K
 M B F L U N U E C M I A K T H J H A V R E Z A M H Z N T J Q
 B K L E T H E P G H R O P K U T I C L T D A K A L Y J Q S Y
 P K K O S I N I H A R A G W Q W S V A T A B R D Q E L V F R
 M O W Z N T Q Y G S F I W I T K G K I C C U B R U H D U Q B
 W J V M D U U B D V Y P S S U S E J L Y L E N A I Z R G V T
 N Q J F R A X S V Y B A G T P M J U R F P D Y P C C Z B B P
 G S B M A F N B B K D D P U I L P O U I A K N L C S B D R K
 K P W Q Z F A P G W F Y S M L A Z Z U T I G M Y M G Y O B Z
 B M E S E T Y P C L B S O F J U N B C S E C Q M R I A N I O
 Y B L Q M Q Q Y Z W E M T O B G F A Q E Y M P T B F E Z U V
 K B V V D H U F H W H U W E J C B M N T A N L F G L M F Q L
 P O D P W A Q O K Z T B I P H V B Z R M Q Q J H B B B N H C
 U H D B Q U T J K O L S H K T U K B U P A R D D I K Z B C Y
 Y S Z Q B U H W R A U E J J J B M T K M O U D R V M U A C Y

ACCUSATION
 AGRIPPA
 APPEALED
 BELIEVE
 BERNICE

CAESARIA
 CHAINS
 CHRISTIAN
 DAMASCUS
 FESTUS

FREE
 JESUS
 KING
 PAUL
 TESTIFY



267. PAUL GOES BEFORE AGRIPPA

(ACTS 25:13-26:32)

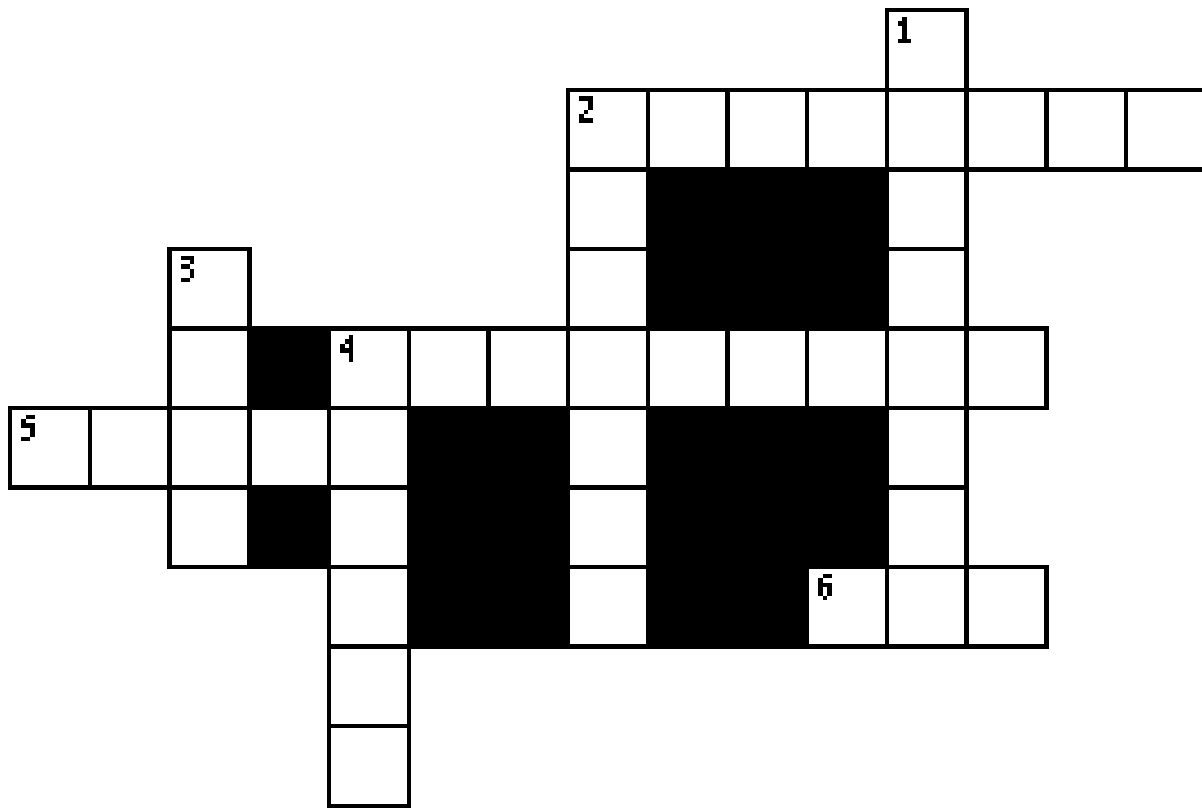

- 1 DOWN "And after some days King Agrippa and Bernice came to _____ to greet Festus." **ACTS 25:13**
- 3 DOWN "So the next day, when Agrippa and Bernice had come with great pomp, and had entered the auditorium with the commanders and the prominent men of the city, at Festus' command _____ was brought in." **ACTS 25:23**
- 2 DOWN "Then _____ said to Paul, 'You are permitted to speak for yourself.' So Paul stretched out his hand and answered for himself." **ACTS 26:1**
- 6 ACROSS "Now as he thus made his defense, Festus said with a loud voice, 'Paul, you are beside yourself! Much learning is driving you _____!'" **ACTS 26:24**
- 5 ACROSS "But he said, 'I am not mad, most noble Festus, but speak the words of _____ and reason.'" **ACTS 26:25**
- 4 ACROSS "Then Agrippa said to Paul, 'You almost persuade me to become a _____.'" **ACTS 26:28**
- 4 DOWN "And Paul said, 'I would to God that not only you, but also all who hear me today, might become both almost and altogether such as I am, except for these _____.'" **ACTS 26:29**
- 2 ACROSS "Then Agrippa said to Festus, 'This man might have been set free if he had not _____ to Caesar.'" **ACTS 26:32**

Bible Story 268

VOYAGE TO ROME

ACTS 27:1-12

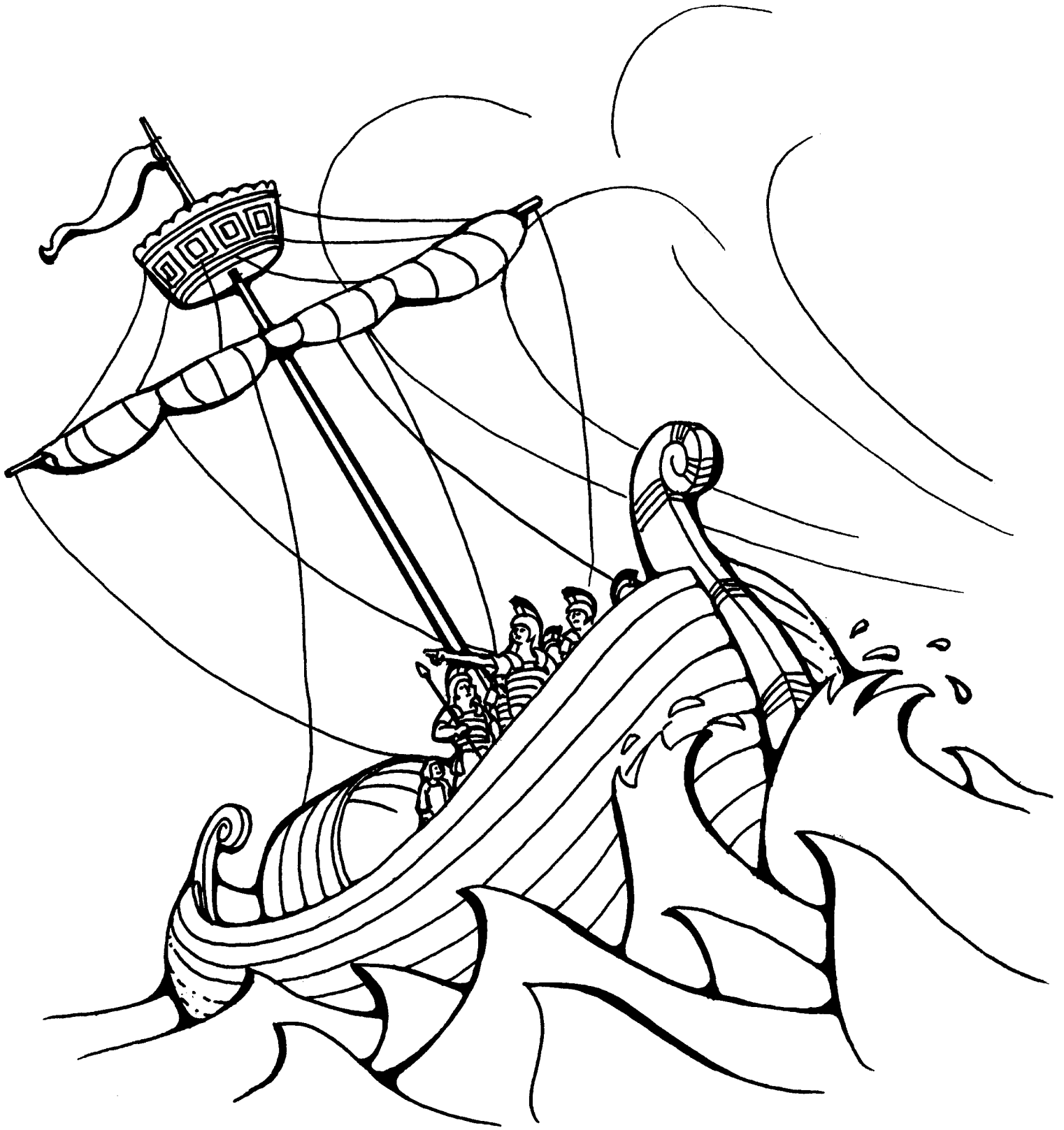

"Paul begins his voyage aboard a ship bound for Rome."
Acts 27:1-12

268. VOYAGE TO ROME

(ACTS 27:1-12)

MEMORY VERSE:

"But none of these things move me; nor do I count my life dear to myself, so that I may finish my race with joy, and the ministry which I received from the Lord Jesus, to testify to the gospel of the grace of God." ACTS 20:24

TRUE OR FALSE:

1. "And when it was decided that we should sail to Italy, they delivered Paul and some other prisoners to one named Julius, a centurion of the Augustan Regiment." **ACTS 27:1**
TRUE OR FALSE
2. Julius treated Paul without kindness and gave him no liberty to go to his friends and receive care. **ACTS 27:3**
TRUE OR FALSE
3. "There the centurion found an Alexandrian ship sailing to Italy, and he put us on board."
ACTS 27:6
TRUE OR FALSE

CIRCLE THE CORRECT WORDS:

4. "Now when much time had been spent, and sailing was now (**SAFE**, **DANGEROUS**) because the Fast was already over, Paul advised them." **ACTS 27:9**
5. "...saying, 'Men, I perceive that this voyage will end with (**DISASTER**, **SUCCESS**) and much loss, not only of the cargo and ship, but also our lives." **ACTS 27:10**

TRUE OR FALSE:

6. Nevertheless the centurion was more persuaded by Paul than by the things spoken by the helmsman and the owner of the ship. **ACTS 27:11**
TRUE OR FALSE

CIRCLE THE CORRECT WORD:

7. "And because the (**HARBOR**, **COUNTRY**) was not suitable to winter in, the majority advised to set sail from there also, if by any means they could reach Phoenix, a harbor of Crete opening toward the southwest and northwest, and winter there." **ACTS 27:12**

268. VOYAGE TO ROME

(ACTS 27:1-12)

D	P	Y	S	W	W	W	Y	G	F	P	R	L	K	A
I	I	Y	H	L	D	S	B	N	L	G	C	B	P	E
S	Q	O	M	Z	W	U	E	G	L	K	M	B	Y	R
A	D	F	B	B	Y	F	D	A	R	B	S	A	T	A
S	J	S	U	O	R	E	G	N	A	D	A	C	R	C
T	Q	V	S	P	P	I	R	Z	S	U	I	W	E	H
E	R	B	V	J	Z	B	C	J	Z	K	L	J	B	A
R	I	S	O	H	W	G	P	I	H	S	E	U	I	H
I	N	O	I	R	U	T	N	E	C	C	D	K	L	Z
O	L	V	J	G	Y	L	A	T	I	U	Y	O	Z	Y
T	S	S	U	I	L	U	J	P	F	B	L	I	Y	S
A	T	M	J	E	B	Y	G	N	D	D	D	T	Y	I
P	R	I	S	O	N	E	R	S	N	L	N	E	O	D
N	F	A	E	U	M	P	R	U	I	S	I	J	J	O
R	A	Z	A	L	U	A	P	O	W	V	K	K	F	N

CARE
CENTURION
DANGEROUS
DISASTER
ITALY

JULIUS
KINDLY
LIBERTY
PAUL
PRISONERS

SAILED
SEA
SHIP
SIDON
WIND

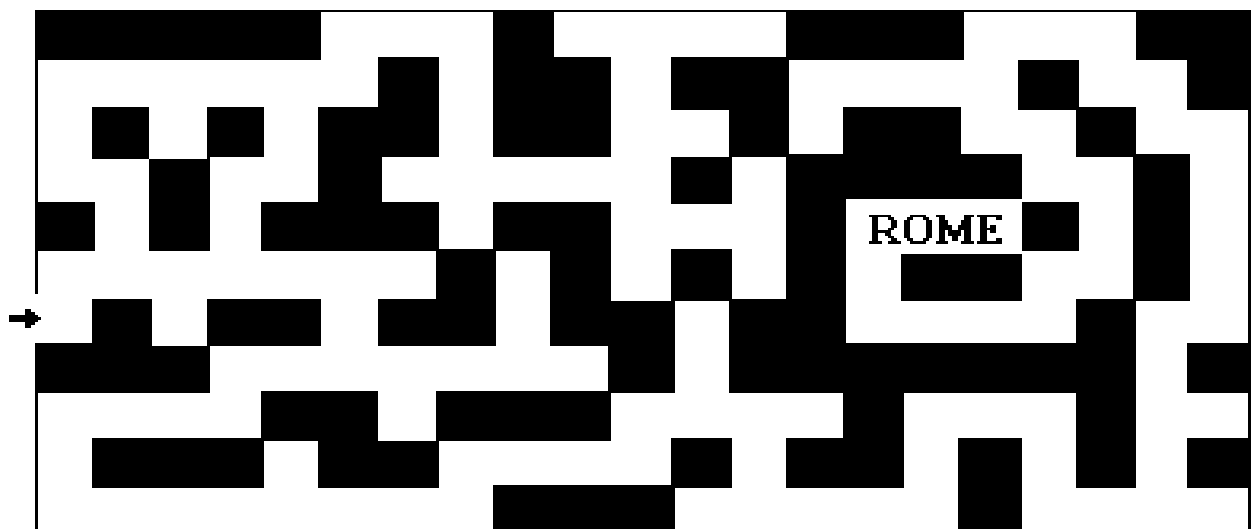

268. VOYAGE TO ROME

(ACTS 27:1-12)

MEMORY VERSE:

"But none of these things move me; nor do I count my life dear to myself, so that I may finish my race with joy, and the ministry which I received from the Lord Jesus, to testify to the gospel of the grace of God." ACTS 20:24

TRUE OR FALSE:

1. "And when it was decided that we should sail to Italy, they delivered Paul and some other prisoners to one named Julius, a centurion of the Augustan Regiment." **ACTS 27:1**
TRUE OR FALSE
2. Julius treated Paul without kindness and gave him no liberty to go to his friends and receive care. **ACTS 27:3**
TRUE OR FALSE
3. "There the centurion found an Alexandrian ship sailing to Italy, and he put us on board." **ACTS 27:6**
TRUE OR FALSE

FILL IN THE BLANKS:

4. "Now when much time had been spent, and sailing was now _____ because the Fast was already over, Paul advised them." **ACTS 27:9**
5. "...saying, 'Men, I perceive that this voyage will end with _____ and much loss, not only of the cargo and ship, but also our lives.'" **ACTS 27:10**

TRUE OR FALSE:

6. Nevertheless the centurion was more persuaded by Paul than by the things spoken by the helmsman and the owner of the ship. **ACTS 27:11**
TRUE OR FALSE

FILL IN THE BLANK:

7. "And because the _____ was not suitable to winter in, the majority advised to set sail from there also, if by any means they could reach Phoenix, a harbor of Crete opening toward the southwest and northwest, and winter there." **ACTS 27:12**

268. VOYAGE TO ROME

(ACTS 27:1-12)

I N S W S M T Y Y Z W T B G I T L B B R P Q Q J H I M I U K
 D G P E Q D Q Q F H Z L S P U P U K T U M A R D D V I J K S
 Y K M L V W H U O K O U E S M L G M P K L O U D R S U L I U
 E B B V P Q A Q J Y A W J L I B E R T Y C Y M R S M B M B N
 D Y B D B B P T W K L Q M O F J I Z Z B S E E M M K W P R E
 P K O D Q I U R S R K D G T O B T B F I G A S J C I V B Q S
 U P H Z J T U H I E U N N W E J A I V F E E Z L U R K E I B
 G U S Z I A T T S S N I O I P H L Z F W Y Q P P R K G C J T
 I Y S O C L T T I N O S V I K T Y F H L U S U I L U J H L I
 C F R W T B D R A C U N S H K J C Z N J W U J O S Q P M J L
 E K V H C Z D R G V D V E J J Y V B E B D T H L J Y H B V E
 U T N Q J Z Q W W C L U P R F R U D E B A V D R L C K I R I
 B G G I W N C P A C U U L D S D B K M K N S C E P Z H V R A
 M E D L Y K U N F H B A T U Y C N B J J G E U T B A C M K K
 K Y P H J O J K U R L D W U A G H U Q K E T U S N K O T J Q
 U G K T T B K B T E Y D B O T P B Y V U R K S A S R V Q S Y
 Y M C Y N H S C C M H W H L W S A E E M O N Y S L V N V F R
 Y Q S A A F M D O E B T J O U Q U E V B U B J I P Z J U Q X
 R H P O R V J W M Q N L Y U G U V J V Y S Y G D H Y L G V T
 F V P A S E T K J N O T K I H M A A L R I Z A T L E D B B P
 H V R V L I A I K Y I A U A E S E V A N A A K P Q H R D R K
 E G B C P O A E G M R O P R B J I K I O C B R N U Z Z O B Z
 L S O A U N U P H A F A G I I Q S U L D L U B R I C B N I O
 M N S L T H E I G S Y P K B V O G O R I P E N A C S Y Z U V
 G B L O N I N Y D V B A S R S L N Z U S D D Y P C G A F Q L
 M K K Z D U Q B P Y D D A W U J J B U N A K N L M I E N H C
 B K W M R A B I V K F Y I G B T P A I T I G M Y R F M B C Y
 P O V F A F H B B W B S L T H W Z W C T E C Q M B L B A C Y
 M J J M Z S N P G L E M E K U K F M Q C Y M P T G B Z D N P
 W Q B Q E F A P C W H U D W Q M B Z N M A N L F B K U P U D

CARE
 CENTURION
 DANGEROUS
 DISASTER
 ITALY

JULIUS
 KINDLY
 LIBERTY
 PAUL
 PRISONERS

SAILED
 SEA
 SHIP
 SIDON
 WIND

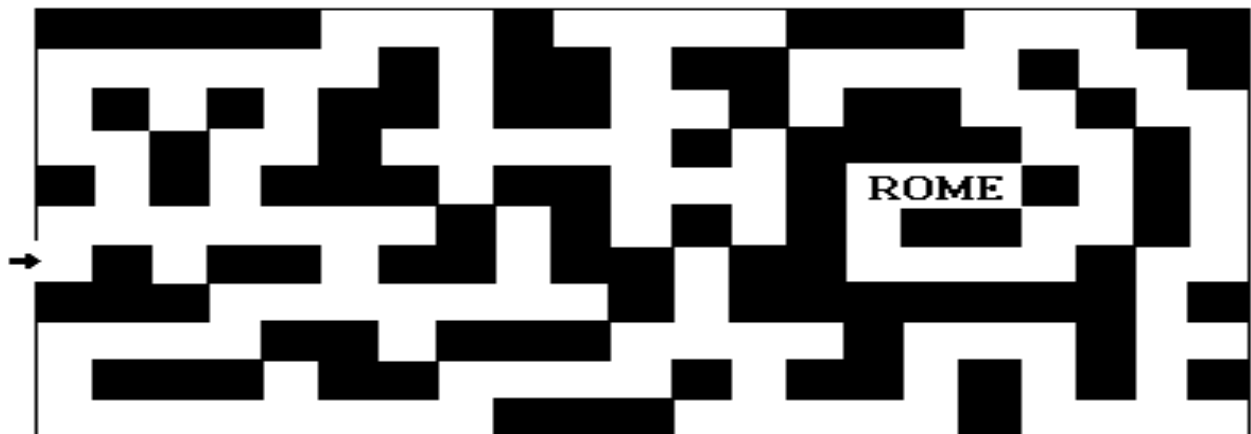

268. VOYAGE TO ROME

(ACTS 27:1-12)

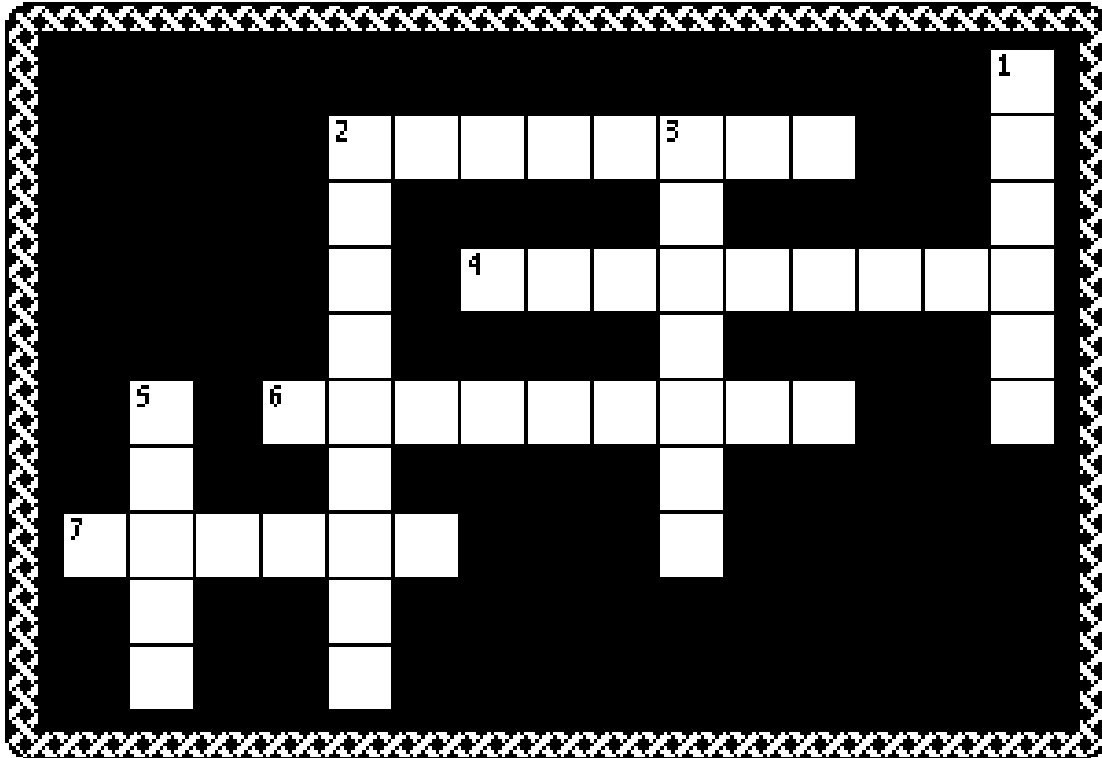

- 3 DOWN "But none of these things move me; nor do I count my life dear to myself, so that I may finish my race with joy, and the ministry which I received from the Lord Jesus, to _____ to the gospel of the grace of God." **ACTS 20:24**
- 6 ACROSS "And when it was decided that we should sail to Italy, they delivered Paul and some other prisoners to one named Julius, a _____ of the Augustan Regiment." **ACTS 27:1**
- 1 DOWN "...Julius treated Paul _____ and gave him liberty to go to his friends and receive care." **ACTS 27:3**
- 5 DOWN "There the centurion found an Alexandrian ship sailing to _____, and he put us on board." **ACTS 27:6**
- 2 DOWN "Now when much time had been spent, and sailing was now _____ because the Fast was already over, Paul advised them..." **ACTS 27:9**
- 2 ACROSS "...saying, 'Men, I perceive that this voyage will end with _____ and much loss, not only of the cargo and ship, but also our lives.'" **ACTS 27:10**
- 4 ACROSS "Nevertheless the centurion was more _____ by the helmsman and the owner of the ship than by the things spoken by Paul." **ACTS 27:11**
- 7 ACROSS "And because the _____ was not suitable to winter in, the majority advised to set sail from there also, if by any means they could reach Phoenix, a harbor of Crete opening toward the southwest and northwest, and winter there." **ACTS 27:12**

Bible Story 269

SHIPWRECK AT MALTA

ACTS 27:13-28:16



"While on the way to Rome, a great storm arose, and Paul and the other prisoners were commanded to jump overboard and swim to land."

Acts 27:13-28:16

269. SHIPWRECK AT MALTA

(ACTS 27:13-28:16)

MEMORY VERSE:

"Because he has set his love upon Me, therefore I will deliver him; I will set him on high, because he has known My name. He shall call upon Me, and I will answer him; I will be with him in trouble; I will deliver him and honor him." PSALM 91:14-15

TRUE OR FALSE:

1. "And because we were exceedingly tempest-tossed, the next day they lightened the ship." **ACTS 27:18**
TRUE OR FALSE

CIRCLE THE CORRECT WORD:

2. "On the third day we threw the ship's (**TACKLE, CAPTAIN**) overboard with our own hands." **ACTS 27:19**

TRUE OR FALSE:

3. "Now when neither sun nor stars appeared for many days, and no small tempest beat on us, all hope that we would be saved was finally given up." **ACTS 27:20**
TRUE OR FALSE
4. "Now I urge you to take heart, for there will be no loss of life among you, but only of the ship." **ACTS 27:22**
TRUE OR FALSE
5. Now the soldiers' plan was to keep all of the prisoners alive so all of them should swim away and escape.
ACTS 27:42
TRUE OR FALSE

CIRCLE THE CORRECT WORDS:

6. "But the centurion, wanting to (**KILL, SAVE**) Paul, kept them from their purpose, and commanded that those who (**COULD, COULDN'T**) swim should jump overboard first and get to land." **ACTS 27:43**
7. "And the natives showed us unusual (**TREES, KINDNESS**); for they kindled a fire and made us all (**AFRAID, WELCOME**), because of the rain that was falling and because of the cold." **ACTS 28:2**

TRUE OR FALSE:

8. But when Paul had gathered a bundle of sticks and laid them on the fire, a bear came out because of the heat, and fastened on his hand. **ACTS 28:3**
TRUE OR FALSE
9. "They also honored us in many ways; and when we departed, they provided such things as were necessary." **ACTS 28:10**
TRUE OR FALSE

CIRCLE THE CORRECT WORD:

10. "Now when we came to (**HOME, ROME**), the centurion delivered the prisoners to the captain of the guard; but Paul was permitted to dwell by himself with the soldier who guarded him." **ACTS 28:16**

269. SHIPWRECK IN MALTA

(ACTS 27:13-28:16)

W T H G U A C V J W P G N F M
 Z B Z N Q A V O H S Y P M U J
 K B K L U A P J G D A Z U P D
 K W I N D Y M J S O E F O G L
 Q E T S E P M E T D D L E K S
 J F C R R Y A E G B R J I L V
 C J T P I O Z A E M B A F A Y
 R T I I L F S W U W D P O B S
 E N O I R U T N E C R D L B R
 T A E S M I W S W B P I H S C
 E E O Q S V H L D F C A L B M
 B J T D T B M Z W I G R M K L
 S O L D I E R S Y B R F S C B
 B Z A J F S B B P G G A Z U B
 R T A E H W S P Z Y N F O O D

AFRAID
 BOARDS
 CAUGHT
 CENTURION
 CRETE
 FOOD

GOD
 JUMP
 PAUL
 SAFELY
 SAILED
 SEA

SHIP
 SOLDIERS
 SWIM
 TEMPEST
 WHEAT
 WIND

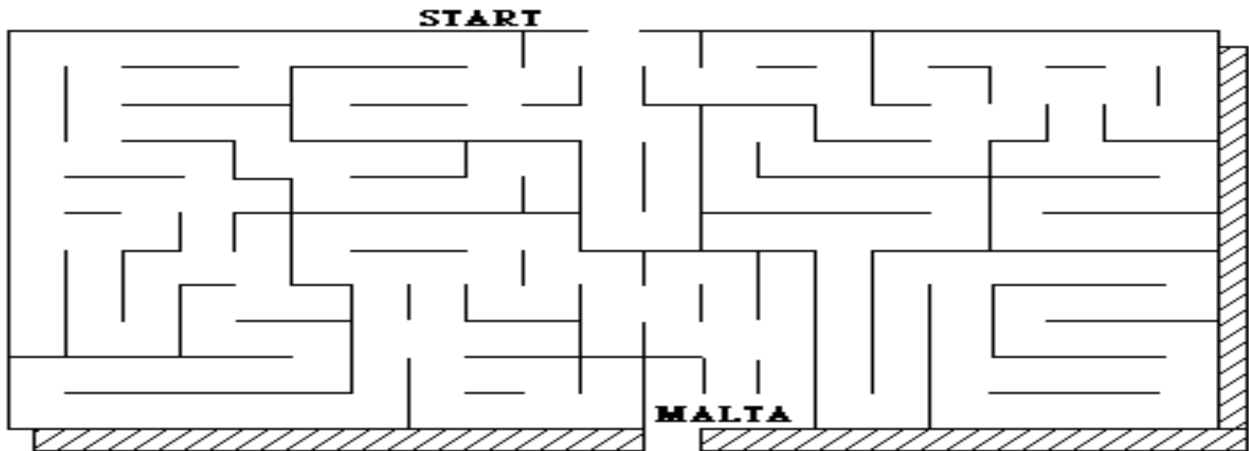

269. SHIPWRECK AT MALTA

(ACTS 27:13-28:16)

MEMORY VERSE:

"Because he has set his love upon Me, therefore I will deliver him; I will set him on high, because he has known My name. He shall call upon Me, and I will answer him; I will be with him in trouble; I will deliver him and honor him." PSALM 91:14-15

TRUE OR FALSE:

1. "And because we were exceedingly tempest-tossed, the next day they lightened the ship." **ACTS 27:18**
TRUE OR FALSE

FILL IN THE BLANK:

2. "On the third day we threw the ship's _____ overboard with our own hands." **ACTS 27:19**

TRUE OR FALSE:

3. "Now when neither sun nor stars appeared for many days, and no small tempest beat on us, all hope that we would be saved was finally given up." **ACTS 27:20**
TRUE OR FALSE
4. "Now I urge you to take heart, for there will be no loss of life among you, but only of the ship." **ACTS 27:22**
TRUE OR FALSE
5. Now the soldiers' plan was to keep all of the prisoners alive so all of them should swim away and escape.
ACTS 27:42
TRUE OR FALSE

FILL IN THE BLANKS:

6. "But the centurion, wanting to _____ Paul, kept them from their purpose, and commanded that those who could _____ should jump overboard first and get to land." **ACTS 27:43**
7. "And the natives showed us unusual _____; for they kindled a fire and made us all _____, because of the rain that was falling and because of the cold." **ACTS 28:2**

TRUE OR FALSE:

8. But when Paul had gathered a bundle of sticks and laid them on the fire, a bear came out because of the heat, and fastened on his hand. **ACTS 28:3**
TRUE OR FALSE
9. "They also honored us in many ways; and when we departed, they provided such things as were necessary." **ACTS 28:10**
TRUE OR FALSE

FILL IN THE BLANK:

10. "Now when we came to _____, the centurion delivered the prisoners to the captain of the guard; but Paul was permitted to dwell by himself with the soldier who guarded him." **ACTS 28:16**

269. SHIPWRECK AT MALTA

(ACTS 27:13-28:16)

W T L I Y Z Z Y L W L J C U L V C T R Y A D T S U K S V U J
T D M I W S K Y Z U M U V H K R Z M K T I Y M F F O O D V V
I Y D A L C C O D F S K T P D F L Z K H Z G G N I N K P P U
W H E V I C T F E I Z O W E D E U S Y G S T G T K M T T I X
P S R V O Q I V L X F I H V O J T H R D N I R Q E C E J R E
P U E B V I O X I G P T P A K O M I G F I I H C Y D F I F A
W Q U Q Q W T S A Y G E J R Q U O P I Y C A U B O A R D S F
Q S W Y Z Z A V S P K J H L K G D J K Q Z P R D B N Y P V I
T C J E S E V I T A N K Q W L F E N U D X G V F T Y R K Q M
A S R L U K N M X Y B K O J W K M S I C R C Y Y A J N D X I
U I N E A K R A P B U P A U K D X M A W P J Y T I D L A I O
U L S N T Q P Z D D K Z W O I B N X V M J N R R A V M Y P Q
H S Z V N E I O J R C Y V E J K O P X R E P I V O E A S O H
J J K Q M J G S H C U Y M P S C B C O P P H T Q W C H G R U
U F B T G B Q H G G M O F T U K E D U O Q E E T A U X W A N
M F Z A F B D M E R D J S C E A U N V E X D U B E A T M V H
P O S R E I D L O S L F W S A T L T T A Q B S K P U O X K P
E P F Q M R J X U G S A U C V W P X Z U F Y S I Q T N T R U
R E H F H A Q S W N V H D H D L M X A Y R K F J T E K L W Y
J O N H A B L V D G R A S U Q A C G U U G I J E F K V A Y N
S O G P W K R T W Z C H J E E P C E E H A K O F V O E B B M
T C X J X E I O A J M Z H C N P V I F A M J S N I O F H G H
A F G T P F L J Y P L Y Q N R A Z K P E M M G S F P G P P B
Z K R B E J S J P N B N O Q Y X K X M R A H O N R F S U F Y
S T E M P E S T Z U C P E S Y V F P T C A V R A N D L V Q A
D B Q I S T T E W A R J W A D Q K P O N O W A G Y H C L K O
J Y I A G E F A U A X T E F J D S U N F K Z P Q M D Y R G M
Q N P M D J A G Y O A P B E I V M Z I I C F A F Z F D R X B
I M H X E Z H E B F C L K L P S O V J R Y I U H U W T E Q H
K H Z T P T D W M L W J S Y T M A F J E U Z L W I Y L V L N

AFRAID

JUMP

SEA

BOARDS

MALTA

SHIP

CAUGHT

NATIVES

SOLDIERS

CENTURION

NO HARM

SWIM

CRETE

PAUL

TEMPEST

FIRE

PRAYED

VIPER

FOOD

SAFELY

WHEAT

GOD

SAILED

WIND

269. SHIPWRECK AT MALTA (ACTS 27:13-28:16)

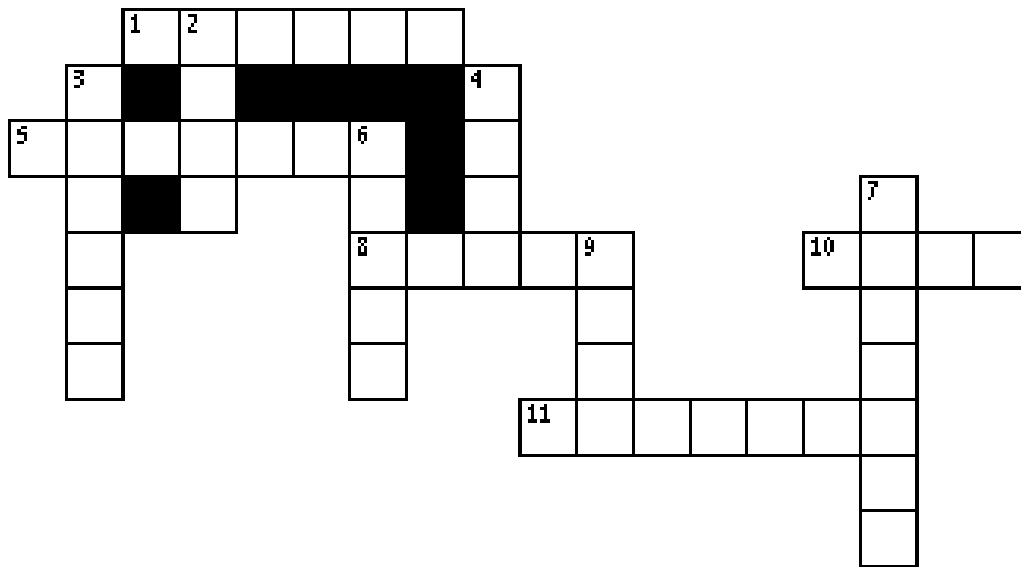

- 11 ACROSS "He shall call upon Me, and I will answer him; I will be with him in trouble; I will _____ him and honor him." **PSALM 91:15**
- 2 DOWN "And because we were exceedingly tempest-tossed, the next day they lightened the _____." **ACTS 27:18**
- 3 DOWN "On the third day we threw the ship's _____ overboard with our own hands." **ACTS 27:19**
- 6 DOWN "Now when neither sun nor stars appeared for many days, and no small tempest beat on us, all hope that we would be _____ was finally given up." **ACTS 27:20**
- 10 ACROSS "Now I urge you to take heart, for there will be no _____ of life among you, but only of the ship." **ACTS 27:22**
- 1 ACROSS "Now the soldiers' plan was to kill the prisoners, lest any of them should swim away and _____." **ACTS 27:42**
- 4 DOWN "But the centurion, wanting to save Paul, kept them from their purpose, and commanded that those who could swim should _____ overboard first and get to land." **ACTS 27:43**
- 5 ACROSS "And the _____ showed us unusual kindness; for they kindled a fire and made us all welcome, because of the rain that was falling and because of the cold." **ACTS 28:2**
- 8 ACROSS "But when Paul had gathered a bundle of sticks and laid them on the fire, a _____ came out because of the heat, and fastened on his hand." **ACTS 28:3**
- 7 DOWN "They also _____ us in many ways; and when we departed, they provided such things as were necessary." **ACTS 28:10**
- 9 DOWN "Now when we came to _____, the centurion delivered the prisoners to the captain of the guard; but Paul was permitted to dwell by himself with the soldier who guarded him." **ACTS 28:16**

Bible Story 270

**PAUL'S
MINISTRY
IN ROME**

ACTS 28:17-31

270. PAUL'S MINISTRY IN ROME (ACTS 28:17-31)



"And when they had appointed him a day, there came many to him into *his* lodging; to whom he expounded and testified the kingdom of God, persuading them concerning Jesus, both out of the law of Moses, and *out of* the prophets, from morning till evening."

ACTS 28:23

270. PAUL'S MINISTRY IN ROME

(ACTS 28:17-31)

MEMORY VERSE:

"Therefore let it be known to you that the salvation of God has been sent to the Gentiles, and they will hear it." ACTS 28:28

TRUE OR FALSE:

1. "It came to pass after three days that Paul called the leaders of the Jews together..."
ACTS 28:17

TRUE OR FALSE

CIRCLE THE CORRECT WORD:

2. "For this reason therefore I have called for you, to see you and speak with you, because for the hope of Israel I am bound with this (**PAIN, CHAIN**)."
ACTS 28:20

TRUE OR FALSE:

3. "They said to him, 'We neither received letters from Judea concerning you, nor have any of the brethren who came reported or spoken evil of you.'" **ACTS 28:21**

TRUE OR FALSE

CIRCLE THE CORRECT WORD:

4. "So when they had appointed him a day, many came to him at his lodging, to whom he explained and solemnly (**TESTIFIED, DENIED**) of the kingdom of God, persuading them concerning Jesus from both the Law of Moses and the Prophets, from morning till evening."
ACTS 28:23

TRUE OR FALSE:

5. "And some were persuaded by the things which were spoken, and some disbelieved."
ACTS 28:24

TRUE OR FALSE

CIRCLE THE CORRECT WORD:

6. "Therefore let it be known you that the (**SALVATION, WRATH**) of God has been sent to the Gentiles, and they will hear it!" **ACTS 28:28**

TRUE OR FALSE:

7. "Then Paul dwelt two whole years in his own rented house, and received all who came to him, preaching the kingdom of God and teaching the things which concern the Lord Jesus Christ with all confidence, no one forbidding him." **ACTS 28:30-31**

TRUE OR FALSE

270. PAUL'S MINISTRY IN ROME

(ACTS 28:17-31)

S	U	S	J	U	D	K	A	D	C	J	K	B	L	M
A	D	U	U	E	D	I	V	A	O	O	K	V	U	S
L	S	H	O	C	O	J	E	Y	T	G	A	Q	G	E
V	J	P	E	N	K	S	D	Y	C	H	A	I	N	L
A	H	D	E	D	A	U	S	R	E	P	T	D	I	I
T	Q	E	P	R	Q	W	Q	D	V	U	W	V	H	T
I	O	V	T	Q	A	I	S	A	I	A	H	S	C	N
O	E	A	C	L	K	S	E	J	R	G	L	M	A	E
N	D	E	V	E	I	L	E	B	S	I	D	C	E	G
V	W	R	S	L	R	E	N	O	S	I	R	P	R	B
M	E	S	T	E	H	P	O	R	P	F	A	E	P	N
F	P	A	U	L	L	U	N	I	F	K	P	M	T	O
H	O	L	Y	S	P	I	R	I	T	D	P	O	M	B
S	B	L	C	K	W	E	R	P	E	B	A	R	O	U
W	K	W	H	G	N	I	H	C	A	E	T	Z	E	L

CAESAR
CHAIN
DISBELIEVED
GENTILES
GOD
HOLY SPIRIT

ISAIAH
LAW
PAUL
PERSUADED
PREACHING

PRISONER
PROPHETS
ROME
SALVATION
TEACHING

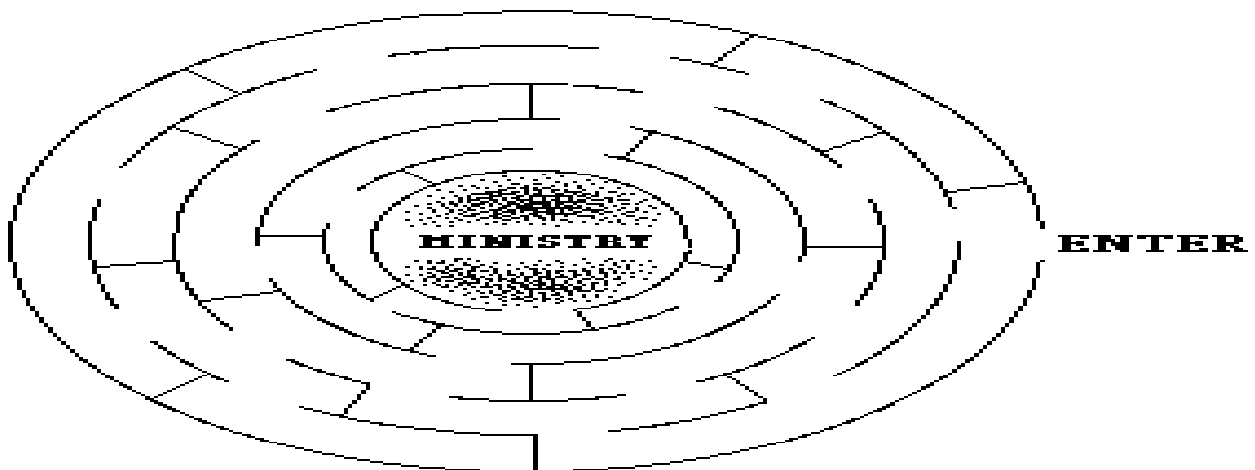

270. PAUL'S MINISTRY IN ROME

(ACTS 28:17-31)

MEMORY VERSE:

"Therefore let it be known to you that the salvation of God has been sent to the Gentiles, and they will hear it." ACTS 28:28

TRUE OR FALSE:

1. "It came to pass after three days that Paul called the leaders of the Jews together..."
ACTS 28:17

TRUE OR FALSE

FILL IN THE BLANK:

2. "For this reason therefore I have called for you, to see you and speak with you, because for the hope of Israel I am bound with this _____." **ACTS 28:20**

TRUE OR FALSE:

3. "They said to him, 'We neither received letters from Judea concerning you, nor have any of the brethren who came reported or spoken evil of you.'" **ACTS 28:21**

TRUE OR FALSE

FILL IN THE BLANK:

4. "So when they had appointed him a day, many came to him at his lodging, to whom he explained and solemnly _____ of the kingdom of God, persuading them concerning Jesus from both the Law of Moses and the Prophets, from morning till evening." **ACTS 28:23**

TRUE OR FALSE:

5. "And some were persuaded by the things which were spoken, and some disbelieved."
ACTS 28:24

TRUE OR FALSE

FILL IN THE BLANK:

6. "Therefore let it be known you that the _____ of God has been sent to the Gentiles, and they will hear it!" **ACTS 28:28**

TRUE OR FALSE:

7. "Then Paul dwelt two whole years in his own rented house, and received all who came to him, preaching the kingdom of God and teaching the things which concern the Lord Jesus Christ with all confidence, no one forbidding him." **ACTS 28:30-31**

TRUE OR FALSE

270. PAUL'S MINISTRY IN ROME

(ACTS 28:17-31)

A S N L U K N A D N L O V O V L M K V U A V A K M K V V B O
 U I R E N O S I R P S J M E D A C B Z H O W S E C T P U Q M
 U L S L A K R Z W G V F F P Q P C P A A K Z F Y D E T V L B
 H S U N N Q P S Y Z R A S T E P V C U E C F N B N F J P J H
 E A Z V M J I H P J C H W C N A Z A E G Y I T T Y Y I I V N
 P J K Q G B Q M Z P M A U S R B K E F C N Z Q I J R P R U B
 R F B T F B D B W N L H D C Y V F S P N U I C O D N K F B V
 J F Z A H R J S B U B Z S H Y Q K A T A D T H W V L D V E I
 S G F Q N O I T A V L A S U D D S R O I Y M D C C M A Q A U
 T O E F A B Q V M O X Y J E J V M P N Z G G Y A A A Y B F S
 A P H N W K R O W F A N H C I S O U I S T G R E U E S I I S
 Z E N H T E I J U L C J Q N P M A Z J N I R Q P A B R P M A
 S O G P B I L J F L W T O Q T C T V J D E D A U S R E P I L
 C O B J P F L E I M J P E L V D M F Y C I H T Q U T G O O Y
 H C G T E J S E B S U L W K R Z I R T Z P U B T T O M R Q J
 A F R B S T T A S Z K J E D F L Z S H B G V K F E N B A H H
 I K T I R I P S Y L O H B D E U J K B R C Y I V K K T V U W
 N B Q I P E F W G F O C K O J T S K G E J Y J I O D L K N Z
 D Y I A G R A L Y P I V S K O M M Y F P L R E F O V A R H A
 J N P M D J O Z P G T T U Q U O B R Y J N I F G O E L W P P
 Q M H B E Z Y P Y K E W H K G E P G Q P H T E R P F B A U B
 I H Z T P Z Y B H B J H P L F M C I D Q E E S V F G H Y W I
 K L I Y Z K O P B E K P E W K B D K C B H U A N E S P B Y C
 T D V L C C F J D U T J V K D N T U M A D S G Y D D E M O R
 D C O N F I D E N C E S A I B O B A I Q B S Q M H L U G N N
 Y R V I C T V H R K K H R J K B B A P F Y F F Z D C V P M Z
 H E B O Q I B G C C P Q L S K U S V O G K J H U F Y L F H F
 U U Q V I O S E G U Z O W U A I G B E A K S W I W D R Q B N
 Q W Y Q W T V U R M Y A J E T L E O A M J G U K Y T R K Y F
 S J E Z Z A M W G D Y W U A W P I U Y M M R I N S L E G A P

CAESAR
 CHAIN
 CONFIDENCE
 DISBELIEVED
 GENTILES
 GOD

HOLY SPIRIT
 ISAIAH
 LAW
 PAUL
 PERSUADED

PREACHING
 PRISONER
 PROPHETS
 ROME
 SALVATION

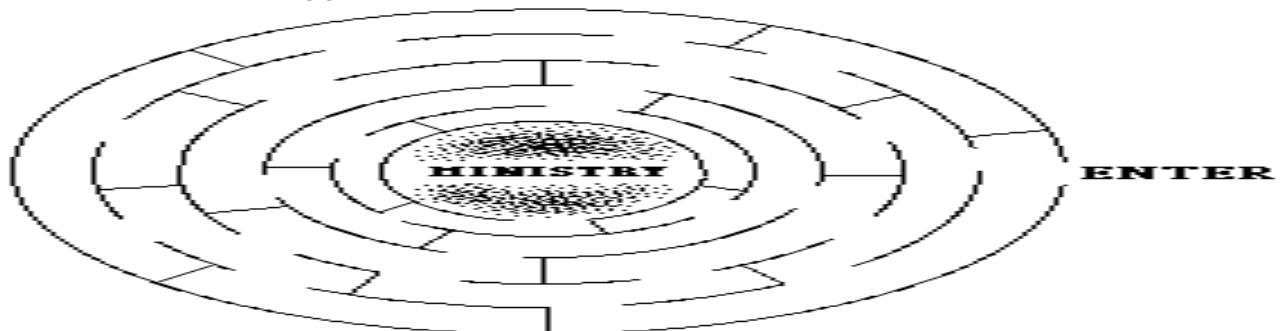

270. PAUL'S MINISTRY IN ROME

(ACTS 28:17-31)

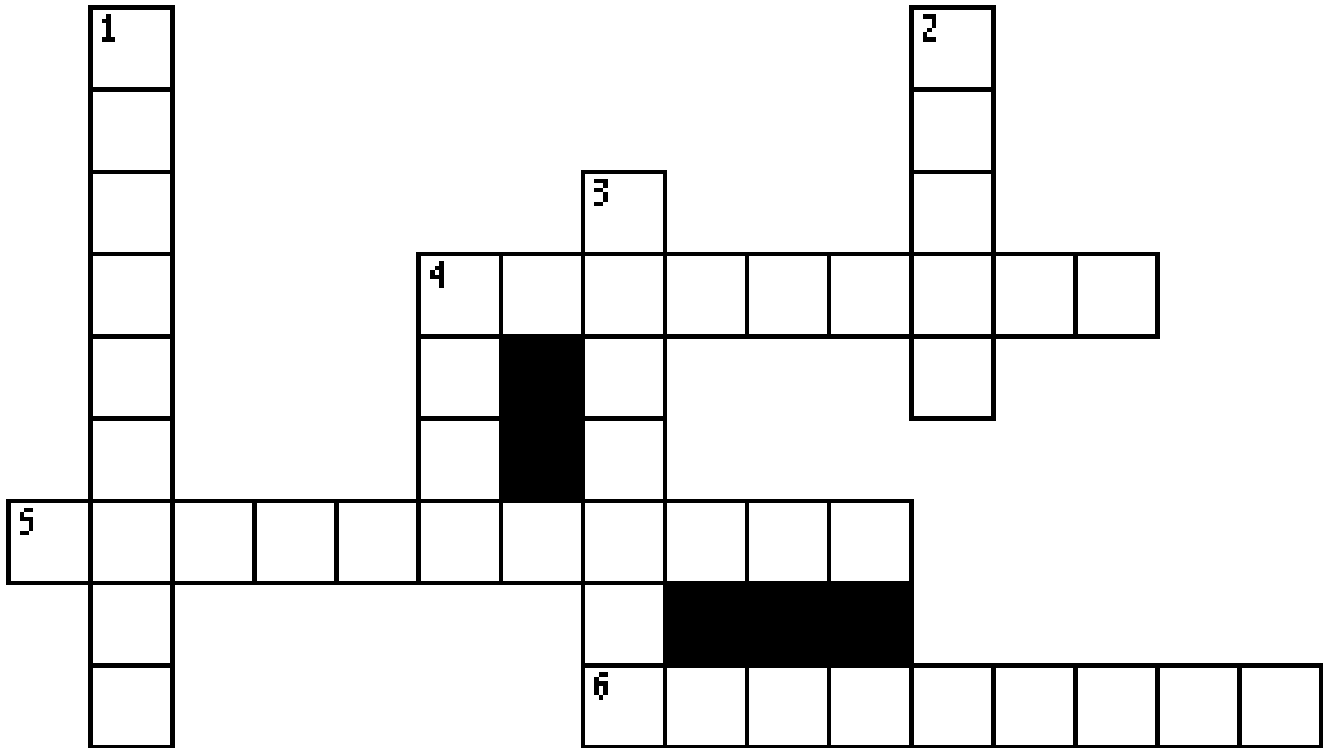

- 4 DOWN "It came to pass after three days that _____ called the leaders of the Jews together..." **ACTS 28:17**
- 2 DOWN "For this reason therefore I have called for you, to see you and speak with you, because for the hope of Israel I am bound with this _____." **ACTS 28:20**
- 3 DOWN "They said to him, 'We neither received _____ from Judea concerning you, nor have any of the brethren who came reported or spoken evil of you.'" **ACTS 28:21**
- 1 DOWN "So when they had appointed him a day, many came to him at his lodging, to whom he explained and solemnly _____ of the kingdom of God, persuading them concerning Jesus from both the Law of Moses and the Prophets, from morning till evening." **ACTS 28:23**
- 5 ACROSS "And some were persuaded by the things which were spoken, and some _____." **ACTS 28:24**
- 6 ACROSS "Therefore let it be known you that the _____ of God has been sent to the Gentiles, and they will hear it!" **ACTS 28:28**
- 4 ACROSS "Then Paul dwelt two whole years in his own rented house, and received all who came to him, _____ the kingdom of God and teaching the things which concern the Lord Jesus Christ with all confidence, no one forbidding him." **ACTS 28:30-31**

Bible Story 271

PAUL WRITES ABOUT FAITH

Romans 3:21-5:5

271. PAUL WRITES ABOUT FAITH

(ROMANS 3:21-5:5)



"And hope maketh not ashamed; because the love of God is shed abroad
in our hearts by the Holy Ghost which is given unto us."

ROMANS 5:5

271. PAUL WRITES ABOUT FAITH

(ROMANS 3:21-5:5)

MEMORY VERSE:

"For all have sinned and fall short of the glory of God, being justified freely by His grace through the redemption that is in Christ Jesus." ROMANS 3:23-24

TRUE OR FALSE:

1. "All have sinned and fallen short of the glory of God." **ROMANS 3:23**
TRUE OR FALSE
2. "...being justified freely by His grace through the redemption that is in Christ Jesus."
ROMANS 3:24
TRUE OR FALSE

CIRCLE THE CORRECT WORD:

3. "Therefore we conclude that a man (**IS, IS NOT**) justified by faith apart from the deeds of the law." **ROMANS 3:28**

UNDERLINE THE CORRECT ANSWER:

4. "Do we then make void the law through faith?..." **ROMANS 3:31**
 - a. Certainly!
 - b. Certainly not!

TRUE OR FALSE:

5. "Therefore, having been justified by faith, we have peace with God through our Lord Jesus Christ." **ROMANS 5:1**
TRUE OR FALSE

CIRCLE THE CORRECT WORD:

6. "Now hope does not disappoint, because the (**LOVE, CUP**) of God has been poured out in our hearts by the Holy Spirit who was given to us." **ROMANS 5:5**

271. PAUL WRITES ABOUT FAITH

(ROMANS 3:21-5:5)

Q	N	C	S	L	B	S	S	O	Q	Y	J	R	M	U
N	I	A	E	N	F	Q	K	C	D	E	I	Z	A	D
E	D	T	L	J	L	K	R	T	W	G	T	B	A	W
P	L	R	I	O	I	Y	O	S	H	S	R	V	V	W
O	G	O	T	I	H	J	W	T	Y	A	I	T	Z	A
H	R	H	N	M	V	B	E	N	H	D	G	W	S	L
N	A	S	E	U	L	O	P	A	G	O	D	V	A	D
F	F	S	G	O	U	S	M	B	C	V	H	B	V	Y
Y	W	B	O	S	I	J	U	S	T	I	F	I	E	D
V	V	D	N	N	M	P	G	F	A	I	T	H	D	N
Y	B	E	N	Z	E	A	F	P	R	O	M	I	S	E
B	S	E	J	E	S	U	S	C	H	R	I	S	T	K
S	D	W	A	D	Y	V	K	U	Z	B	Q	W	Q	P
F	Q	D	J	C	Y	T	K	G	R	A	C	E	B	H
P	J	I	T	A	S	C	R	I	P	T	U	R	E	Q

ABRAHAM
BLOOD
DAVID
FAITH
GENTILES

GOD
GRACE
HOPE
JESUS CHRIST
JEWS

JUSTIFIED
LAW
PROMISE
RIGHTEOUSNESS
SAVED

SCRIPTURE
SHORT
SINNED
WORKS



271. PAUL WRITES ABOUT FAITH

(ROMANS 3:21-5:5)

MEMORY VERSE:

"For all have sinned and fall short of the glory of God, being justified freely by His grace through the redemption that is in Christ Jesus." ROMANS 3:23-24

TRUE OR FALSE:

1. "All have sinned and fallen short of the glory of God." **ROMANS 3:23**
TRUE OR FALSE
2. "...being justified freely by His grace through the redemption that is in Christ Jesus."
ROMANS 3:24
TRUE OR FALSE

FILL IN THE BLANK:

3. "Therefore we conclude that a man is justified by _____ apart from the deeds of the law."
ROMANS 3:28

UNDERLINE THE CORRECT ANSWER:

4. "Do we then make void the law through faith?..." **ROMANS 3:31**
 - a. Certainly!
 - b. Certainly not!

TRUE OR FALSE:

5. "Therefore, having been justified by faith, we have peace with God through our Lord Jesus Christ." **ROMANS 5:1**
TRUE OR FALSE

FILL IN THE BLANKS:

6. "Now hope does not disappoint, because the _____ of _____ has been poured out in our hearts by the Holy Spirit who was given to us." **ROMANS 5:5**

271. PAUL WRITES ABOUT FAITH

(ROMANS 3:21-5:5)

N F Z P E Z D M Q Y I V U P I O B S Y V T Z S Z A
 V W A R E U G H D B L H K L V I L R Q E G V R B Z
 S B N F B G P Y O F A Y Y O E L L V K N F K R S Z
 L Y S M D F C Y O L W G H P M D D J G J I A V B E
 B L H E V D V M K K P M S D N S N D O A H B B E S
 M N U T A Y U B P I K B F E B U J U J A P M K W G
 I D S V N I I P Z F A I T H L E K V M H R S G G Y
 O C I L P F P S S Q R U Q Q S I S C M N O H P B M
 B D Y M E B N R S S E V B U A A T G N Y M J E T X
 K V W O R K S Y T E N E S J V J A N R W I L I D O
 E O J E U L S R V S N C H E S L U O E C S B N P L
 Y S N Z T A C E G O H S D J P J W Q M G E B A T F
 T K D I P E N B W R A Z U C W T K A I N Y K V C W
 E L Y I I Z P V I E I U M O J B Y E F R S N I P U
 Z D I D R C C S D Z P U G B E V Y G J G W P W N U
 Q F G Z C L T T K P Q I Q V H T E A Q I E F A B Y
 V A B R S W D O A E F B W D N Q H T E K J H M I O
 L B L P A O X J G U R Q G I F O H G P F M J H V L
 S R O Z O C C Q T R O H S M G V L N I T R K L G P
 D B U L Y C E L S V C B B O I Y B B G R A Z A U H
 R E B V G G O D E I F I T S U J R K G S U W Z K O
 S E N U N A X P A F G V W O E B O L L T V W Y J P
 B W P N W Z P V U I O B D F G C W D Y O W V E W E
 B G W D I S R G K U W W I U W J H O T Y A H K S Z
 Z F C W Y S E Y S H J Y C D K N J H P T T W G F P

ABRAHAM
 BLOOD
 DAVID
 FAITH
 GENTILES

GOD
 GRACE
 HOPE
 JESUS CHRIST
 JEWS

JUSTIFIED
 LAW
 PROMISE
 RIGHTEOUSNESS
 SAVED

SCRIPTURE
 SHORT
 SINNED
 WORKS



271. PAUL WRITES ABOUT FAITH

(ROMANS 3:21-5:5)

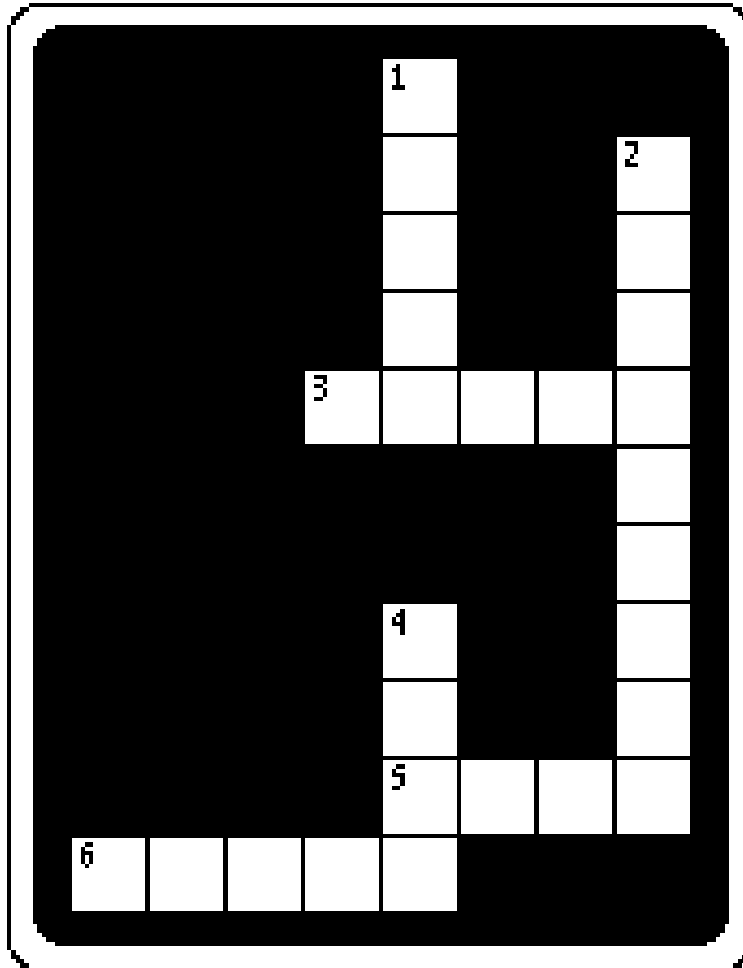

- 3 ACROSS "All have sinned and fallen _____ of the glory of God." **ROMANS 3:23**
- 6 ACROSS "...being justified freely by His _____ through the redemption that is in Christ Jesus." **ROMANS 3:24**
- 1 DOWN "Therefore we conclude that a man is justified by _____ apart from the deeds of the law."
ROMANS 3:28
- 5 ACROSS "Do we then make _____ the law through faith? Certainly not!" **ROMANS 3:31**
- 2 DOWN "Therefore, having been _____ by faith, we have peace with God through our Lord Jesus Christ."
ROMANS 5:1
- 4 DOWN "Now hope does not disappoint, because the _____ of God has been poured out in our hearts by the Holy Spirit who was given to us." **ROMANS 5:5**

Bible Story 272

**THERE IS THEREFORE
NOW NO
CONDEMNATION**

ROMANS 8:1-12

**272. THERE IS THEREFORE NOW NO CONDEMNATION
(ROMANS 8:1-12)**



"There is therefore now no condemnation to them which are in Christ Jesus, who walk not after the flesh, but after the Spirit. For the law of the Spirit of life in Christ Jesus hath made me free from the law of sin and death."

ROMANS 8:1-2

272. THERE IS THEREFORE NOW NO CONDEMNATION (ROMANS 8:1-12)

MEMORY VERSE:

"There is therefore now no condemnation for those who are in Christ Jesus, who do not walk according to the flesh, but according to the Spirit." ROMANS 8:1

TRUE OR FALSE:

1. "There is therefore now no condemnation for those who are in Christ Jesus, who do not walk according to the flesh, but according to the Spirit." **ROMANS 8:1**
TRUE OR FALSE

CIRCLE THE CORRECT WORD:

2. "For the law of the Spirit of life has made me (**FREE, RUNNING**) from the law of sin and death." **ROMANS 8:2**

TRUE OR FALSE:

3. "For those who live according to the flesh set their minds on the things of the flesh, but those who live according to the Spirit, the things of the Spirit." **ROMANS 8:5**
TRUE OR FALSE

CIRCLE THE CORRECT WORD:

4. "For to be carnally minded is (**DEATH, GOOD**), but to be spiritually minded is life and peace."
ROMANS 8:6

TRUE OR FALSE:

5. So then, those who are in the flesh can please God. **ROMANS 8:8**
TRUE OR FALSE

6. "But you are not in the flesh but in the Spirit, if indeed the Spirit of God dwells in you."
ROMANS 8:9
TRUE OR FALSE

272. THERE IS THEREFORE NOW NO CONDEMNATION (ROMANS 8:1-12)

C	H	R	I	S	T	J	E	S	U	S	B	F	D	N
S	M	L	V	Q	W	B	P	I	R	M	Q	Q	O	F
C	H	I	T	D	D	I	O	P	C	B	B	C	L	V
N	S	F	O	O	R	F	E	K	G	U	O	E	I	D
P	R	E	J	I	K	L	Z	R	O	N	S	B	C	L
C	O	B	T	O	A	K	P	E	D	H	V	H	P	L
N	T	P	Q	K	D	I	E	E	W	V	B	M	L	E
O	B	R	L	P	G	E	M	N	J	E	W	G	O	W
S	E	Y	P	W	S	N	S	A	V	Z	Y	E	P	D
B	D	R	A	Z	A	Q	U	I	H	U	E	Q	D	D
C	Y	L	V	T	A	S	V	I	A	R	U	W	Q	E
B	Y	E	I	S	U	S	F	P	F	R	K	G	J	A
P	N	O	G	T	K	D	I	Q	Y	U	Y	B	J	T
R	N	I	Y	V	S	O	U	P	E	A	C	E	C	H
E	M	B	S	G	Y	G	H	F	G	I	H	W	B	I

CHRIST JESUS
DEATH
DEBTORS
DWELL
FLESH

FREE
GOD
LAW
LIFE
NO CONDEMNATION

PEACE
RAISED
SIN
SON
SPIRIT

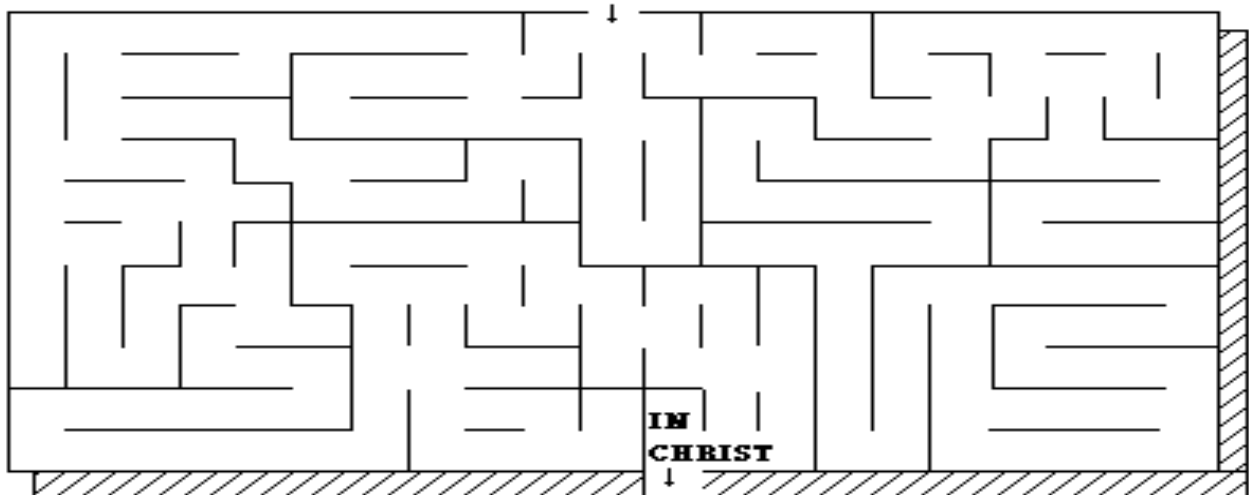

THERE IS NOW NO CONDEMNATION

272. THERE IS THEREFORE NOW NO CONDEMNATION (ROMANS 8:1-12)

MEMORY VERSE:

"There is therefore now no condemnation for those who are in Christ Jesus, who do not walk according to the flesh, but according to the Spirit." ROMANS 8:1

TRUE OR FALSE:

1. "There is therefore now no condemnation for those who are in Christ Jesus, who do not walk according to the flesh, but according to the Spirit." **ROMANS 8:1**
TRUE OR FALSE

FILL IN THE BLANK:

2. "For the law of the Spirit of life has made me _____ from the law of sin and death."
ROMANS 8:2

TRUE OR FALSE:

3. "For those who live according to the flesh set their minds on the things of the flesh, but those who live according to the Spirit, the things of the Spirit." **ROMANS 8:5**
TRUE OR FALSE

FILL IN THE BLANK:

4. "For to be carnally minded is _____, but to be spiritually minded is life and peace."
ROMANS 8:6

TRUE OR FALSE:

5. So then, those who are in the flesh can please God. **ROMANS 8:8**
TRUE OR FALSE

6. "But you are not in the flesh but in the Spirit, if indeed the Spirit of God dwells in you."
ROMANS 8:9
TRUE OR FALSE

272. THERE IS THEREFORE NOW NO CONDEMNATION (ROMANS 8:1-12)

D W O D Z U J G T H D N I O H F G N N O
 C V N T H W Q G F V D G C R H B S W W B
 B G C T R D B T Z Z V B N I B Q Z B I M
 O J B Q A O Z E B U V L E Y B R R W O G
 P T B F A N L L C D D L B D E S I A R Q
 O F I N J O P L S F K N P S B K O B C O
 R G F F Y I Q S E H B F U Y U D J H V T
 J J A T G T L V L W L D O G L F R V M H
 Y W W H H A A P S E D B H D Y I E B G K
 M J B D S N L Z S G S T U Y S H E H D W
 G H B T E M L H N S A Z R T L L R C O W
 U G Y N Q E M S I E D S J B H T F O T B
 U B K Y M D S N D U H E J O I D L Y C L
 O A Y B B N O M P Q S V B R B I L K U R
 V B T P B O A B M U P M I T K P A E V Q
 V H P B C C L A S J P P Z J O M G O N C
 R P N U B O K K E V S L F B K R H J V R
 F T S O B N N F N Q A O J V B W S S M H
 W Q J L S K I I Q W R N F G D L G Z U N
 P B V N Y L M Y Q D B G E W O E C A E P

CHRIST JESUS
 DEATH
 DEBTORS
 DWELL
 FLESH

FREE
 GOD
 LAW
 LIFE
 NO CONDEMNATION

PEACE
 RAISED
 SIN
 SON
 SPIRIT

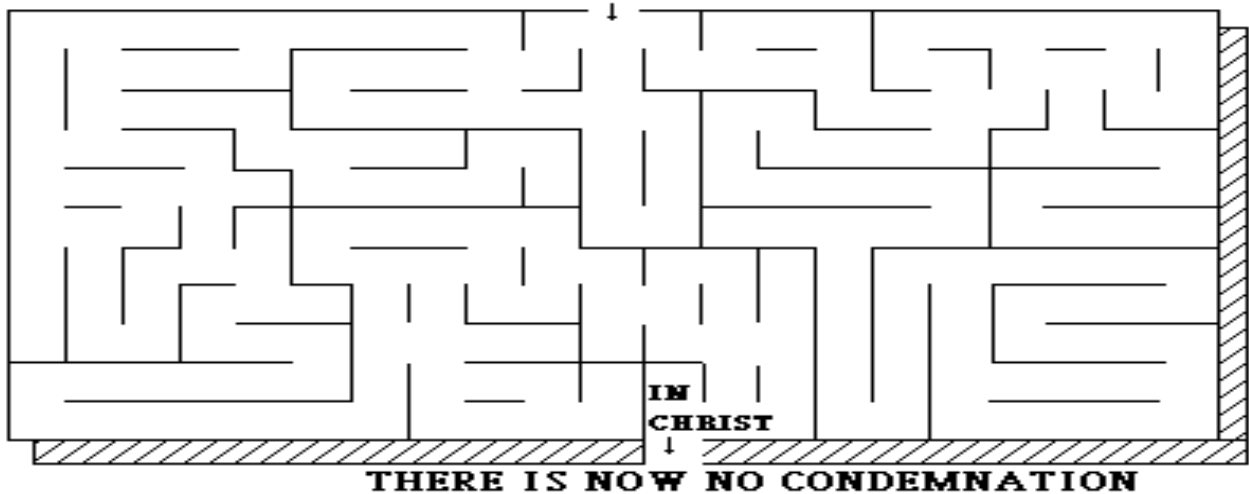

272. THERE IS THEREFORE NOW NO CONDEMNATION (ROMANS 8:1-12)

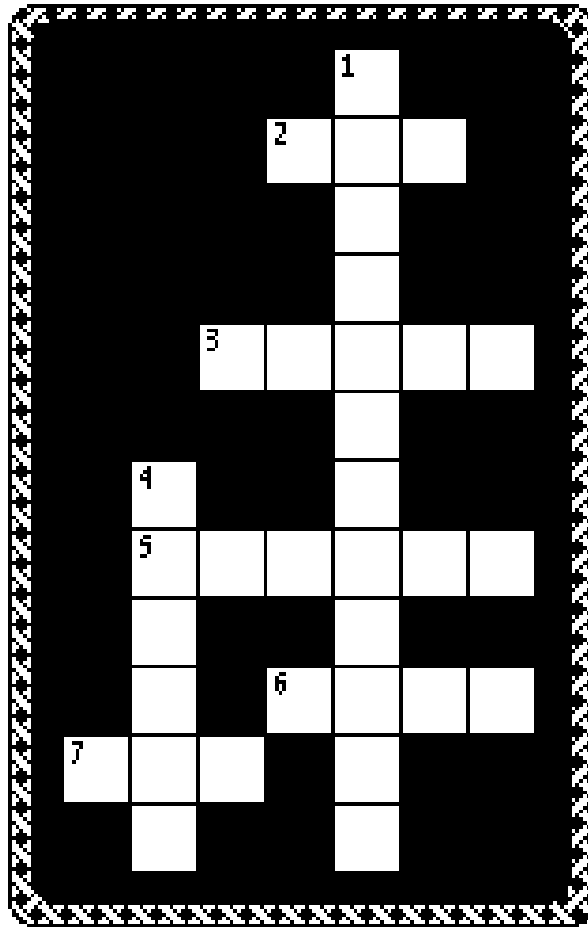

- 1 DOWN "There is therefore now no _____ for those who are in Christ Jesus..." **ROMANS 8:1**
- 4 DOWN "...who do not walk according to the flesh, but according to the _____." **ROMANS 8:1**
- 7 ACROSS "For the law of the Spirit of life has made me free from the law of _____ and death." **ROMANS 8:2**
- 3 ACROSS "For those who live according to the _____ set their minds on the things of the flesh, but those who live according to the Spirit, the things of the Spirit." **ROMANS 8:5**
- 6 ACROSS "For to be carnally minded is death, but to be spiritually minded is _____ and peace." **ROMANS 8:6**
- 5 ACROSS "So then, those who are in the flesh cannot _____ God." **ROMANS 8:8**
- 2 ACROSS "But you are not in the flesh but in the Spirit, if indeed the Spirit of _____ dwells in you." **ROMANS 8:9**

Bible Story 273

SHARING THE GOSPEL

ROMANS 10:1-11:36

273. SHARING THE GOSPEL

(ROMANS 10:1-11:36)



"For with the heart man believeth unto righteousness; and with the mouth confession is made unto salvation."

ROMANS 10:10

273. SHARING THE GOSPEL

(ROMANS 10:1-11:36)

MEMORY VERSE:

"How beautiful upon the mountains are the feet of him who brings good news, who proclaims peace, who brings glad tidings of good things!" ISAIAH 52:7

Paul wrote to the Romans...

TRUE OR FALSE:

1. "Brethren, my heart's desire and prayer to God for Israel is that they may be saved." **ROMANS 10:1**
TRUE OR FALSE
2. "For they being ignorant of God's righteousness, and seeking to establish their own righteousness, have not submitted to the righteousness of God." **ROMANS 10:3**
TRUE OR FALSE

CIRCLE THE CORRECT WORD:

3. But the Bible says, "that if you confess with your mouth the Lord Jesus and believe in your heart that God raised Him from the dead, you will be (SAVED, LOST)." **ROMANS 10:9**

TRUE OR FALSE:

4. "For with the heart one believes to righteousness, and with the mouth confession is made to salvation."
ROMANS 10:10
TRUE OR FALSE

Paul asks these questions... "How then shall they call on Him in whom they have not believed? And how shall they believe in Him of whom they have not heard? And how shall they hear without a preacher? And how shall they preach unless they are sent?" ROMANS 10:14-15

5. "So then faith comes by hearing, and hearing by the word of God." **ROMANS 10:17**
TRUE OR FALSE
6. "Oh, the depth of the riches both of the wisdom and knowledge of God!..." **ROMANS 11:33**
TRUE OR FALSE

CIRCLE THE CORRECT WORD:

"...How unsearchable are His judgments and His ways (EASY, PAST) finding out!" ROMANS 11:33

273. SHARING THE GOSPEL

(ROMANS 10:1-11:36)

W O R D O F G O D S P Y M S O
 B R C K M V L P U S R B V D S
 G L O R Y E O F F E O V S M Z
 T K N P B M R L B N M R R V B
 N S F T K T D C B S I L O C E
 A J E G K R J S Y U S N O U L
 N D S S A P E W O O E Q T M I
 M D S I C Z S A H E O S I J E
 E L S R H K U L S T A E S D V
 R E W E I G S H E H R H R E E
 D P C T L L R E L G F C A V S
 P S N T D U O A F I A N E A U
 F O S O R A Y R C R I A L S D
 T G P P E P D T V E T R C W C
 V D C P N R U W B Z H B L W Q

BELIEVE
 BRANCHES
 CHILDREN
 CONFESS
 FAITH
 FLESH

GLORY
 GOSPEL
 GRACE
 HEART
 ISRAEL
 LAW

LORD JESUS
 MERCY
 PAUL
 POTTER
 PROMISE
 RAISED

REMNANT
 RIGHTEOUSNESS
 ROOT
 SAVED
 WORD OF GOD

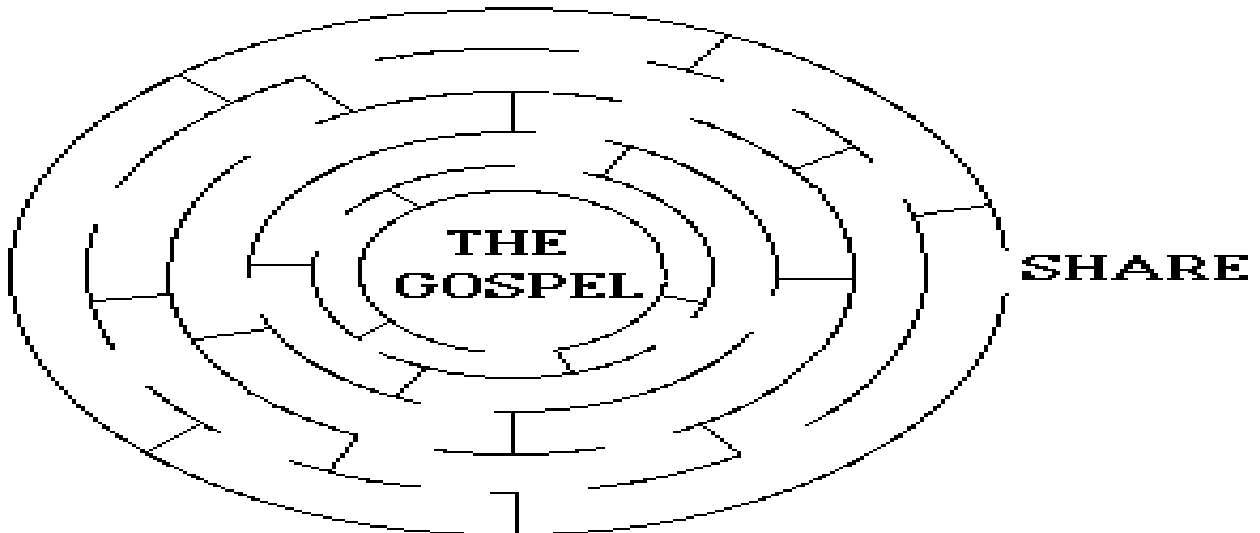

273. SHARING THE GOSPEL

(ROMANS 10:1-11:36)

MEMORY VERSE:

"How beautiful upon the mountains are the feet of him who brings good news, who proclaims peace, who brings glad tidings of good things!" ISAIAH 52:7

Paul wrote to the Romans...

TRUE OR FALSE:

1. "Brethren, my heart's desire and prayer to God for Israel is that they may be saved." **ROMANS 10:1**
TRUE OR FALSE
2. "For they being ignorant of God's righteousness, and seeking to establish their own righteousness, have not submitted to the righteousness of God." **ROMANS 10:3**
TRUE OR FALSE

FILL IN THE BLANK:

3. But the Bible says, "that if you confess with your mouth the Lord Jesus and believe in your heart that God raised Him from the dead, you will be _____." **ROMANS 10:9**

TRUE OR FALSE:

4. "For with the heart one believes to righteousness, and with the mouth confession is made to salvation." **ROMANS 10:10**
TRUE OR FALSE

Paul asks these questions... "How then shall they call on Him in whom they have not believed? And how shall they believe in Him of whom they have not heard? And how shall they hear without a preacher? And how shall they preach unless they are sent?" **ROMANS 10:14-15**

5. "So then faith comes by hearing, and hearing by the word of God." **ROMANS 10:17**
TRUE OR FALSE
6. "Oh, the depth of the riches both of the wisdom and knowledge of God!..." **ROMANS 11:33**
TRUE OR FALSE

FILL IN THE BLANK:

"...How unsearchable are His judgments and His ways _____ finding out!" **ROMANS 11:33**

273. SHARING THE GOSPEL

(ROMANS 10:1-11:36)

J H A N P F H L V O L Q P B A E N B Y Z K Z B Y Z E F V T I
V S L P P J B L M T C H E F K S F W Y Y P R E T E A R S Q G
D E K M R F K A G H M E B H I Z Y D S S H F O B R R H C D B A
T Q N N B E K G D K G N L V L R V I Q V Q M N H I V R R U F
T M M Q N O B H O W K P I E O L Y A K X O C R Q Y L L F V W
Q B G Q G R D G T W M T A L Z U X J Y T Z R L A M V S N D Z
F B G H B I O N D X P L I C I C F T J G F I B Y R O L G E W
N C T V L Y F W O E E S R J H R P L P E V E I L E B P C H R
F B E Z L S B B G L S Z S I J S N N A H L P D E S R H V M U
T B L U N Y Q W F R I I O E Z K E J V Q Q Z V D I I E V U J
H Y S D B D R B O Q P T M T N G I L E A R S I B L E F B N Z
D U V F Z Y K V D C L T N O T S D O F Z P V Z D L R Z W C Q
T W P H S B D B R R E B T B R W U I T T S Q R I R T L J P I
N D Z G V O F H O H P S V I T P L O N T B E R Z E Q V A A T
Y O S U M J H C W N K M S B I T G A E W N Q K F T S U B J F
B K M Q O C L O C N S E B K J D N M P T U U E A T L O E K T
P J B J N V D Y U V H H K B H M R U G V H S G K O W T D R A
B Q A V G G I K V C N V C E E C H Z F B D G L Q P O L C L U
U B K Q I W P E N G U Y A R I T A D B W Z D I A O S Z V C C
L Z I D C H M A N R W R E B I V F C B M O E I R W J J H B M
N P Y D N H R O V K T B U A J S W A O S U S E J D R O L B P
Z Q T D E B W J M Z S L F F B U V B C V B B V S N R P H B W
H L F V B C L S U L C M Z A B K B D T Z U B M W D Q E A U Q
R A Z V P B O Z O B T E B Y R Y E F N Q O U V Y G U N H J Z
A L B D U B G N B I P J L B B V G L B B B Q O U W S R B Y K
A L C K U B S N F V M E E C A R Q I U U T J V F Z O B E Z Q
Y C R E M U Z W M E P L Q S A F J H Q W L A O I A K I U D K
J M S B R L R I G S S D A C Q D C V D D R D F E K S R D D P
Y S L S J Y O O O V S S E M K Q A M Y Y F I B O Z J B J H U
W O S H Z L J G Q T D Z L U L N S E C N F O J D E S I A R Q

BELIEVE
BRANCHES
CHILDREN
CONFESS
FAITH
FLESH

GLORY
GOSPEL
GRACE
HEART
ISRAEL
LAW

LORD JESUS
MERCY
PAUL
POTTER
PROMISE
RAISED

REMNANT
RIGHTEOUSNESS
ROOT
SAVED
WORD OF GOD



273. SHARING THE GOSPEL

(ROMANS 10:1-11:36)

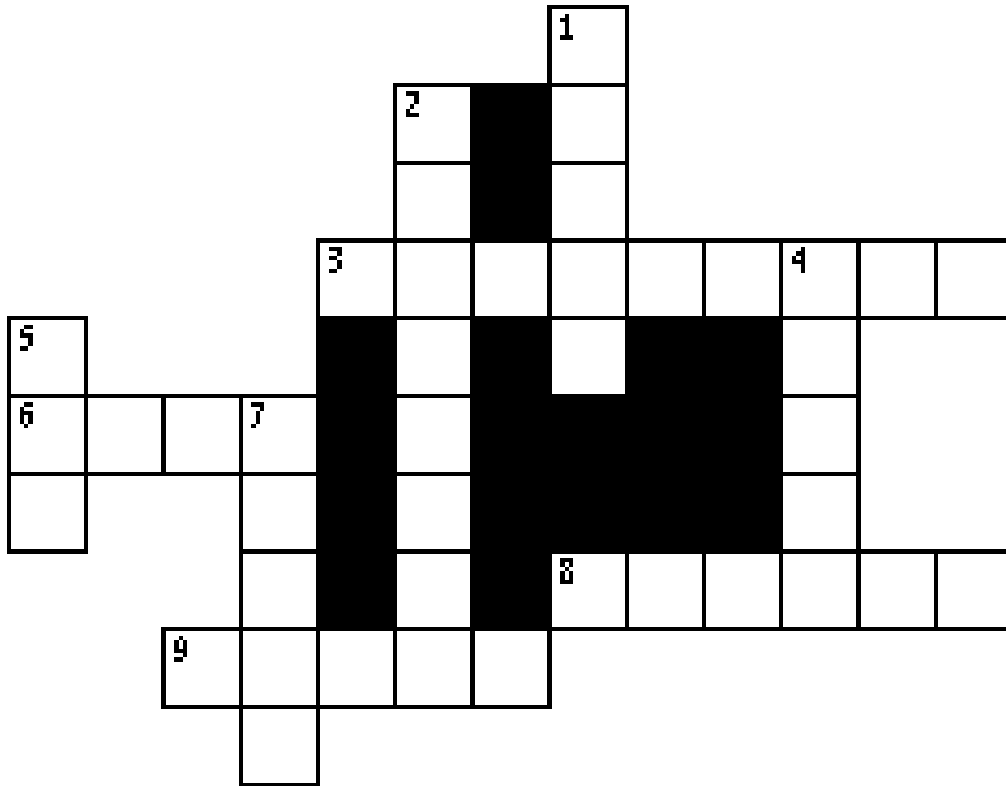

- 3 ACROSS "How ____ upon the mountains are the feet of him who brings good news, who proclaims peace, who brings glad tidings of good things!" **ISAIAH 52:7**
- 7 DOWN "Brethren, my heart's desire and prayer to God for Israel is that they may be ____." **ROMANS 10:1**
- 5 DOWN "For they being ignorant of God's righteousness, and seeking to establish their ____ righteousness, have not submitted to the righteousness of God." **ROMANS 10:3**
- 1 DOWN "...if you confess with your mouth the Lord ____ and believe in your heart that God raised Him from the dead, you will be saved." **ROMANS 10:9**
- 9 ACROSS "For with the ____ one believes to righteousness, and with the mouth confession is made to salvation." **ROMANS 10:10**
- 2 DOWN "How then shall they call on Him in whom they have not believed? And how shall they believe in Him of whom they have not heard? And how shall they hear without a ____? And how shall they preach unless they are sent?" **ROMANS 10:14-15**
- 4 DOWN "So then ____ comes by hearing, and hearing by the word of God." **ROMANS 10:17**
- 8 ACROSS "Oh, the depth of the ____ both of the wisdom and knowledge of God!..." **ROMANS 11:33**
- 6 ACROSS "...How unsearchable are His judgments and His ____ past finding out!" **ROMANS 11:33**

Bible Story 274

**BE A
LIVING SACRIFICE
TO GOD**

ROMANS 12:1-15:13

274. BE A LIVING SACRIFICE TO GOD

(ROMANS 12:1-15:13)

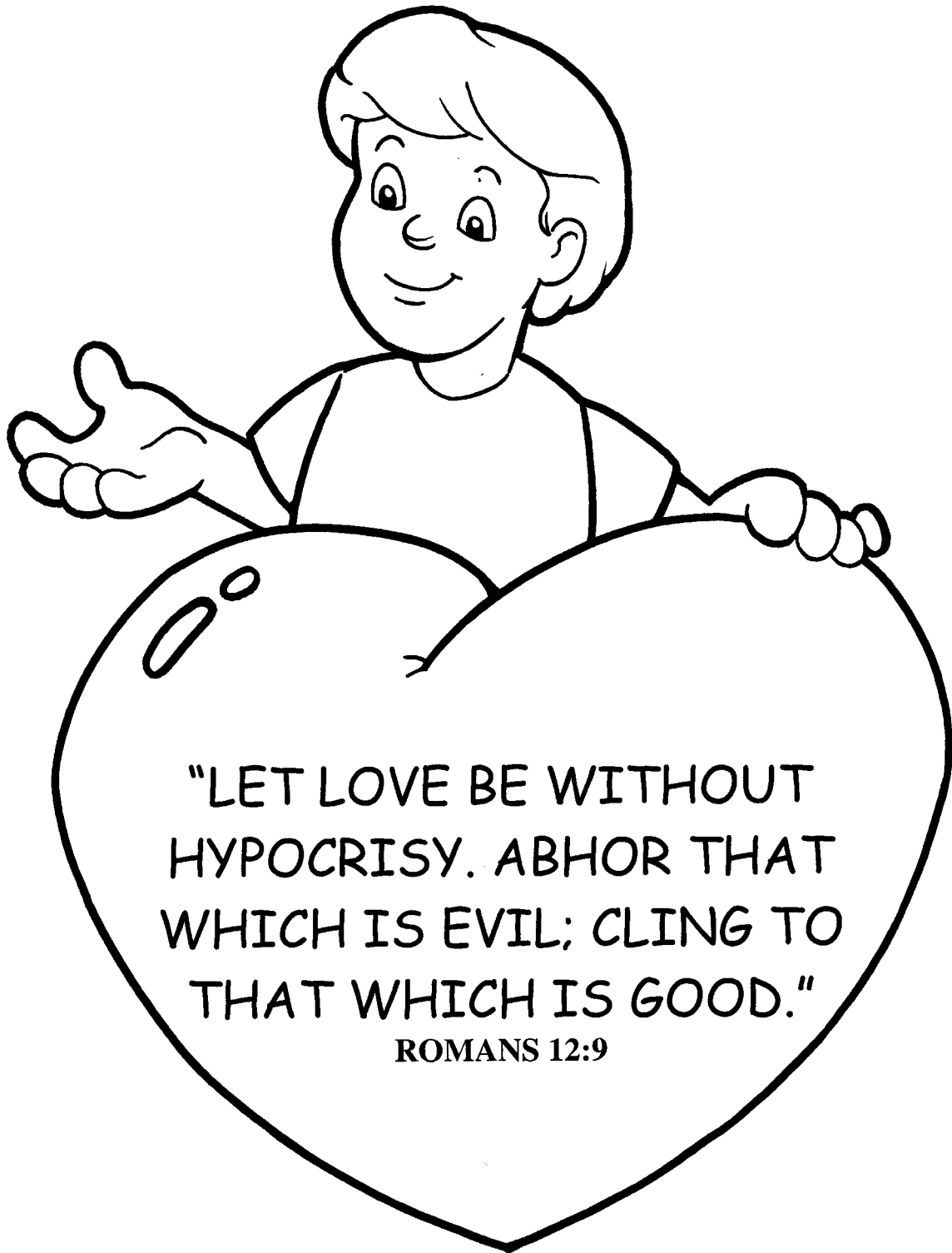

274. BE A LIVING SACRIFICE TO GOD

(ROMANS 12:1-15:13)

MEMORY VERSE:

"I beseech you therefore, brethren, by the mercies of God, that you present your bodies a living sacrifice, holy, acceptable to God, which is your reasonable service." ROMANS 12:1

CIRCLE THE CORRECT WORD:

1. "Do not be conformed to this world, but be transformed by the renewing of your mind, that you may prove what is good and acceptable and perfect will of (GOD, MEN)." ROMANS 12:2

MATCHING: ROMANS 12

- | | |
|-------------------------------------|----------------|
| 2. ___ vs 9 Let love be without | a. hope |
| ___ vs 9 Abhor what is | b. hypocrisy |
| ___ vs 9 Cling to what is | c. tribulation |
| ___ vs 12 Rejoicing in | d. evil |
| ___ vs 12 Patient in | e. prayer |
| ___ vs 12 Continuing steadfastly in | f. good |

CIRCLE THE CORRECT WORDS:

3. "(LOVE, A DOVE) does no harm to a neighbor; therefore (LOVE, A DOVE) is the fulfillment of the law." ROMANS 13:10
4. "And do this knowing the time, that now it is high time to awake out of sleep; for now our salvation is (NEARER, FARTHER) than when we first believed." ROMANS 13:11

TRUE OR FALSE:

5. (13:12) "The night is far spent, the day is at hand. Therefore let us cast off the works of darkness, and let us put on the armor of light." _____
- (13:14) "Put on the Lord Jesus Christ, and make no provision for the flesh, to fulfill its lusts." _____
- (15:2) "Let not each of us please his neighbor for his good, leading to edification." _____
- (15:4) "For whatever things were written before were written for our learning, that we through the patience and comfort of the Scriptures might have hope." _____
- (15:7) "Therefore receive one another, just as Christ also received us, to the glory of God." _____

274. BE A LIVING SACRIFICE TO GOD

(ROMANS 12:1-15:13)

C Z O Q M Y B P A D V S U U D V Y B J T
 T E B H J Q C Y F V C V N F F U S H D K
 C M H A Y U T F U A C C E P T A B L E W
 J D E L L Q D I T B C Y U L B U M J U I
 W W O C T I W O R L O V E E L B M U H U
 Y H F U I T V E C I V R E S E A U Y O M
 J Q V U A O K I O G P K D Y H D B K L F
 T B I T A H J J N C H S D O G D S P O O
 N I O T G T I E Y G R W Y H T W E G U E
 A T N D B R E W R F S L S L L T J K I P
 S M H D U L A S M Z I A L E O L M G L K
 L A E Q E T E C J H E R C B I H G P L J
 P L I M N R P S E K M W O R U D O S I F
 U B U C B R I S S K Q M T L I A O O W Y
 T Z A U S E Y I K R I W C O G F V B I T
 N Z F T Q W R A G N N F E I W O I T B W
 D N F J B P B S D E A Z J R Q A S C R U
 R I F K N N B G H I Y O B F N P P W E G
 G C H R I S T W T N M A U Y I A T I W H
 A K T S A K P H G C A K S B S D W H G B

ACCEPTABLE
 BLESS
 BODIES
 CHRIST
 FAITH
 GIFTS
 GLORIFY

GOD
 GRACE
 HOLY
 HOLY SPIRIT
 HUMBLE
 LIVING SACRIFICE
 LOVE

MEMBERS
 MIND
 REJOICE
 SERVICE
 SUBJECT
 WILL

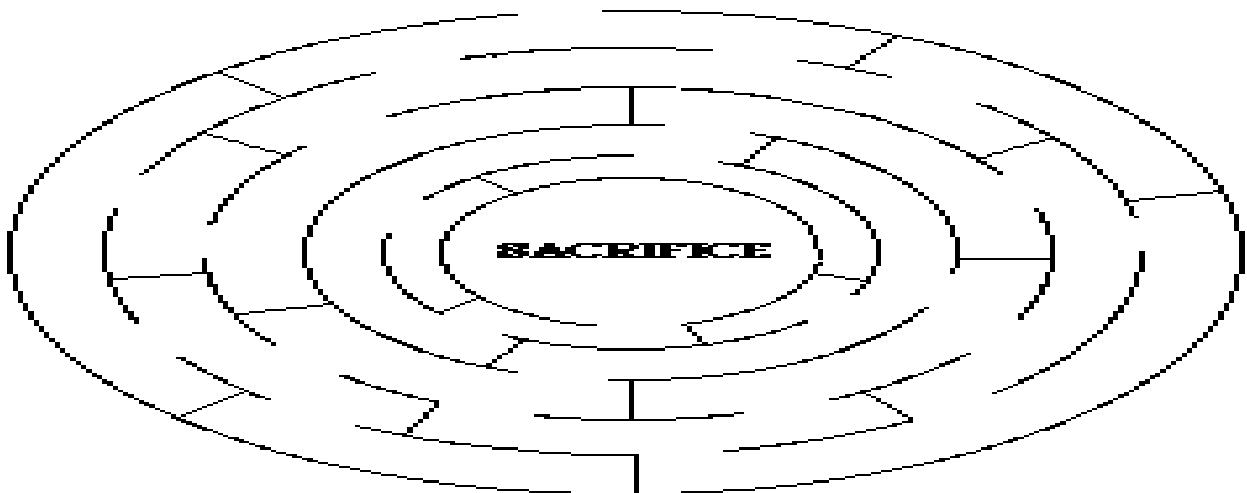

274. BE A LIVING SACRIFICE TO GOD

(ROMANS 12:1-15:13)

MEMORY VERSE:

"I beseech you therefore, brethren, by the mercies of God, that you present your bodies a living sacrifice, holy, acceptable to God, which is your reasonable service."
ROMANS 12:1

FILL IN THE BLANK:

1. "Do not be conformed to this world, but be transformed by the renewing of your mind, that you may prove what is good and acceptable and perfect will of _____." **ROMANS 12:2**

MATCHING: ROMANS 12

- | | |
|-------------------------------------|----------------|
| 2. ___ vs 9 Let love be without | a. hope |
| ___ vs 9 Abhor what is | b. hypocrisy |
| ___ vs 9 Cling to what is | c. tribulation |
| ___ vs 12 Rejoicing in | d. evil |
| ___ vs 12 Patient in | e. prayer |
| ___ vs 12 Continuing steadfastly in | f. good |

FILL IN THE BLANKS:

3. "_____ does no harm to a neighbor; therefore _____ is the fulfillment of the law."
ROMANS 13:10
4. "And do this knowing the time, that now it is high time to awake out of sleep; for now our salvation is _____ than when we first believed." **ROMANS 13:11**

TRUE OR FALSE:

5. (13:12) "The night is far spent, the day is at hand. Therefore let us cast off the works of darkness, and let us put on the armor of light." _____
- (13:14) "Put on the Lord Jesus Christ, and make no provision for the flesh, to fulfill its lusts." _____
- (15:2) "Let not each of us please his neighbor for his good, leading to edification." _____
- (15:4) "For whatever things were written before were written for our learning, that we through the patience and comfort of the Scriptures might have hope." _____
- (15:7) "Therefore receive one another, just as Christ also received us, to the glory of God." _____

274. BE A LIVING SACRIFICE TO GOD

(ROMANS 12:1-15:13)

C Z O Q M Y B P A D V S U U D V Y B J T
 T E B H J Q C Y F V C V N F F U S H D K
 C M H A Y U T F U A C C E P T A B L E W
 J D E L L Q D I T B C Y U L B U M J U I
 W W O C T I W O R L O V E E L B M U H U
 Y H F U I T V E C I V R E S E A U Y O M
 J Q V U A O K I O G P K D Y H D B K L F
 T B I T A H J J N C H S D O G D S P O O
 N I O T G T I E Y G R W Y H T W E G U E
 A T N D B R E W R F S L S L L T J K I P
 S M H D U L A S M Z I A L E O L M G L K
 L A E Q E T E C J H E R C B I H G P L J
 P L I M N R P S E K M W O R U D O S I F
 U B U C B R I S S K Q M T L I A O O W Y
 T Z A B S E Y I K R I W C O G F V B I T
 N Z F T Q W R A G N N F E I W O I T B W
 D N F J B P B S D E A Z J R Q A S C R U
 R I F K N N B G H I Y O B F N P P W E G
 G C H R I S T W T N M A U Y I A T I W H
 A K T S A K P H G C A K S B S D W H G B

ACCEPTABLE
 BLESS
 BODIES
 CHRIST
 FAITH
 GIFTS
 GLORIFY

GOD
 GRACE
 HOLY
 HOLY SPIRIT
 HUMBLE
 LIVING SACRIFICE
 LOVE

MEMBERS
 MIND
 REJOICE
 SERVICE
 SUBJECT
 WILL

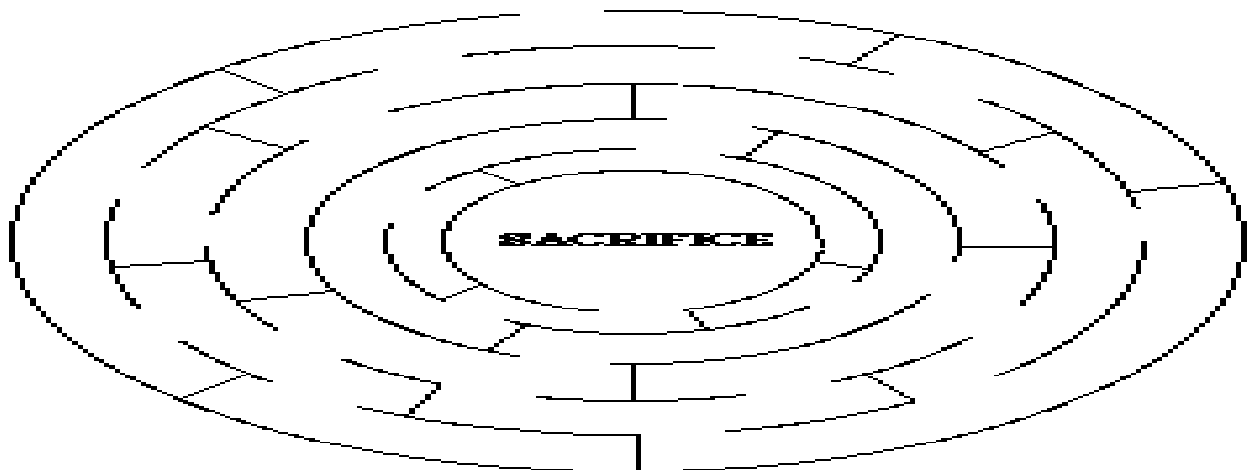

274. BE A LIVING SACRIFICE TO GOD

(ROMANS 12:1-15:13)

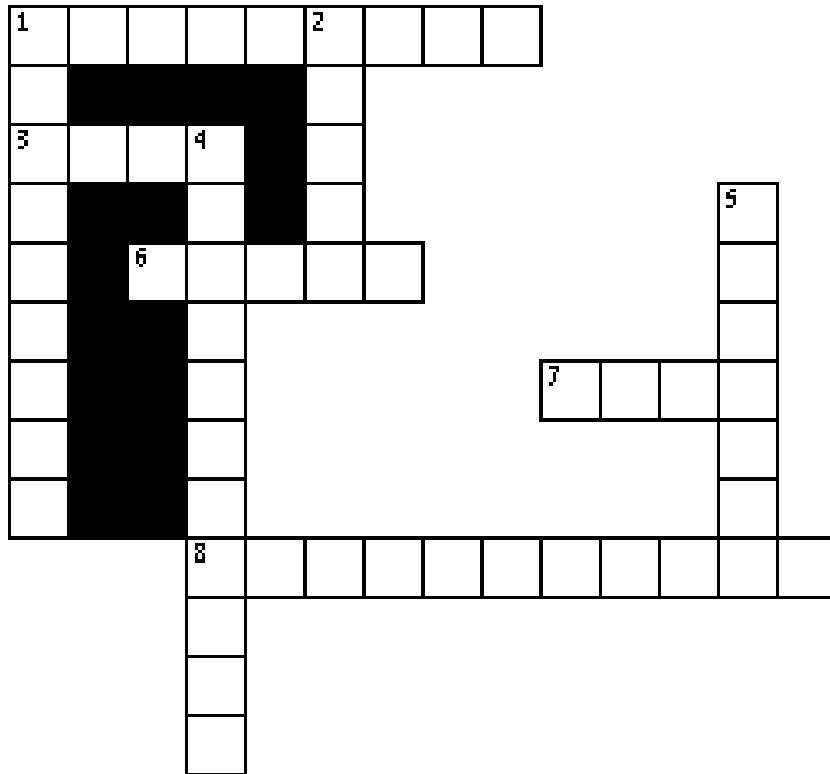

- 1 ACROSS "I beseech you therefore, brethren, by the mercies of God, that you present your bodies a living _____, holy, acceptable to God, which is your reasonable service." **ROMANS 12:1**
- 8 ACROSS "Do not be conformed to this world, but be _____ by the renewing of your mind, that you may prove ` what is good and acceptable and perfect will of God." **ROMANS 12:2**
- 3 ACROSS "____ does no harm to a neighbor; therefore love is the fulfillment of the law." **ROMANS 13:10**
- 1 DOWN "And do this knowing the time, that now it is high time to awake out of sleep; for now our _____ is nearer than when we first believed." **ROMANS 13:11**
- 6 ACROSS "The night is far spent, the day is at hand. Therefore let us cast off the works of darkness, and let us put on the armor of _____." **ROMANS 13:12**
- 2 DOWN "Put on the Lord Jesus Christ, and make no provision for the _____, to fulfill its lusts." **ROMANS 13:14**
- 4 DOWN "Let each of us please his neighbor for his good, leading to _____." **ROMANS 15:2**
- 7 ACROSS "For whatever things were written before were written for our learning, that we through the patience and comfort of the Scriptures might have _____." **ROMANS 15:4**
- 5 DOWN "Therefore _____ one another, just as Christ also received us, to the glory of God." **ROMANS 15:7**

Bible Story 275

**GOD'S CALL-
THAT NO FLESH
SHOULD GLORY**

1 CORINTHIANS 1:26-30

275. GOD'S CALL- THAT NO FLESH SHOULD GLORY
(1 CORINTHIANS 1:26-30)



"That, according as it is written, He that glorieth, let him glory in the Lord."
1 CORINTHIANS 1:31

275. GOD'S CALL- THAT NO FLESH SHOULD GLORY (1 CORINTHIANS 1:26-30)

MEMORY VERSE:

*"But God has chosen the foolish things of the world to put to shame the wise, and God has chosen the weak things of the world to put to shame the things which are mighty."
1 CORINTHIANS 1:27*

CIRCLE THE CORRECT WORD:

1. "For you see your (**CRYING**, **CALLING**), brethren, that not many wise according to the flesh, not many mighty, not many noble, are called." **1 CORINTHIANS 1:26**

TRUE OR FALSE:

2. "God has chosen the foolish things of the world to put to shame the wise."
1 CORINTHIANS 1:27

TRUE OR FALSE

3. "and the base things of the world and the things which are despised God has chosen..."
1 CORINTHIANS 1:28

TRUE OR FALSE

Why has God chosen these things?

FILL IN THE BLANK:

4. "...that ___ flesh should glory in His presence." **1 CORINTHIANS 1:29**

TRUE OR FALSE:

5. "...that, as it is written, 'He who glories, let him glory in the LORD.'" **1 CORINTHIANS 1:31**

TRUE OR FALSE

275. GOD'S CALL-THAT NO FLESH SHOULD GLORY

(1 CORINTHIANS 1:26-30)

V P J D Q Z F B H C U T R P I
 C B T E Y Z C A L L I N G I A
 A H S C B N V A A U E H W Y G
 L I S R H N A M I G H T Y B W
 W Q N I I R W M U J N T P B A
 O J A A L K I E T K Q D N P F
 Z I E G T O I S A O B E K P U
 M C S S L O O F T K N S B Y T
 F N L Z A O O F B J N I C F D
 M T O E A B R F T S E P D O O
 Q C P F N B N Y T M A S W J G
 S J U M L O H T D J Y E U W O
 Q W T D L E B Q D T Q D K S M
 W I S D O M S L Q A U T I S J
 V Y N W B H I H E A Q R E S K

BASE
 CALLING
 CHRIST JESUS
 DESPISED
 FOOLISH

GLORY
 GOD
 MIGHTY
 NOBLE
 NO FLESH

NOT MANY
 WEAK
 WISDOM
 WISE

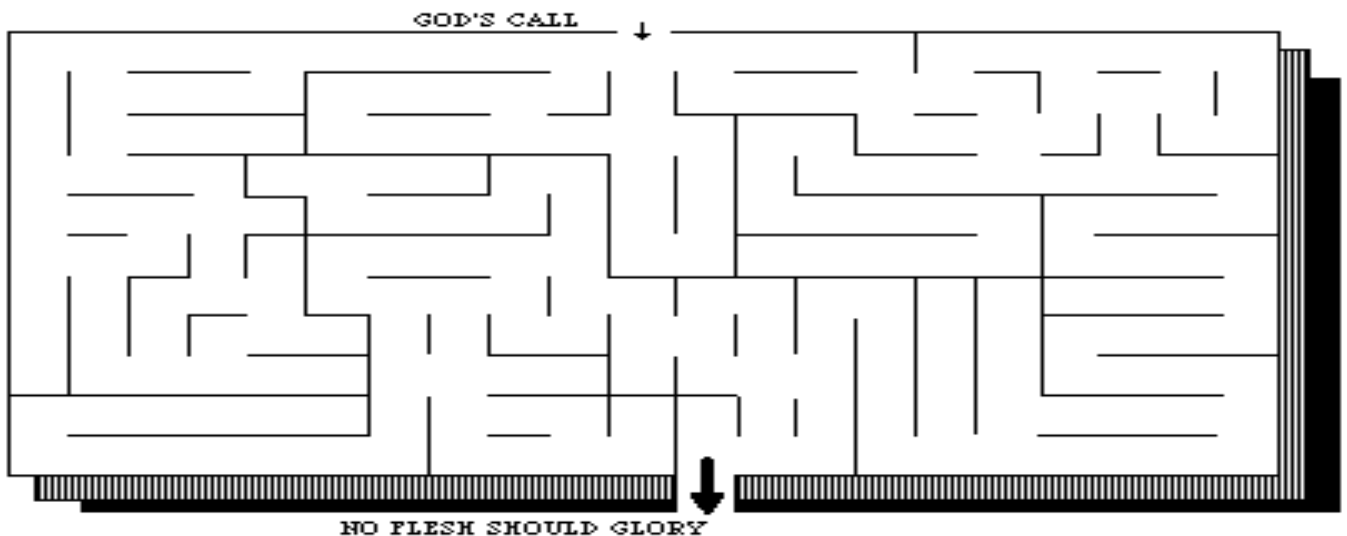

275. GOD'S CALL- THAT NO FLESH SHOULD GLORY

(1 CORINTHIANS 1:26-30)

MEMORY VERSE:

"But God has chosen the foolish things of the world to put to shame the wise, and God has chosen the weak things of the world to put to shame the things which are mighty."
1 CORINTHIANS 1:27

FILL IN THE BLANK:

1. "For you see your _____, brethren, that not many wise according to the flesh, not many mighty, not many noble, are called." **1 CORINTHIANS 1:26**

TRUE OR FALSE:

2. "God has chosen the foolish things of the world to put to shame the wise." **1 CORINTHIANS 1:27**
TRUE OR FALSE
3. "and the base things of the world and the things which are despised God has chosen..."
1 CORINTHIANS 1:28
TRUE OR FALSE

Why has God chosen these things?

FILL IN THE BLANKS:

4. "...that ____ _____ should glory in His presence." **1 CORINTHIANS 1:29**

TRUE OR FALSE:

5. "that, as it is written, 'He who glories, let him glory in the LORD.'" **1 CORINTHIANS 1:31**
TRUE OR FALSE

275. GOD'S CALL-THAT NO FLESH SHOULD GLORY (1 CORINTHIANS 1:26-30)

R I S P P L D S P W I B O M J U B B A J
 E F D W R P K S K J B H P O H J L R E M
 D B G I E V A H S I L O O F N L L O G N
 E L P S M G G O R V Q M D O F J D W A R
 M Y C E H Y S S S E N S U O E T H G I R
 P N H C Y Q A E E H B G Q F G T N H T M
 T A S B Y N Y T H G I M J U I B K J N K
 I M E S M D O Z N Y V Q J D G L O R Y A
 O T L U B C U I A G B W C I E V A S B E
 N O F S P O A P T M W G B V G Q U R K W
 Y N O E R O K L I A Y B V E W O D V L I
 G A N J Y K S E L B C W D M K O W J D F
 N E V T R P Y U P I U I D N G V K D O J
 W Z U S E Z B V Q U N E F B O Y Y U H W
 Y C I I B S F F F V S G I I I B B V Y I
 Z L P R V T L I R P K D N A T A Y C Q S
 U W N H T V K B I E Y I O S S C E G K D
 G C S C O G I S C Z H C B E L C N O G O
 F A C C J W E H G U F P L P D J H A O M
 Y Z N B Q D Q I O U Q L E W S N L Q S Q

BASE
 CALLING
 CHRIST JESUS
 DESPISED
 FOOLISH
 GLORY

GOD
 MIGHTY
 NOBLE
 NO FLESH
 NOT MANY
 REDEMPTION

RIGHTEOUSNESS
 SANCTIFICATION
 WEAK
 WISDOM
 WISE

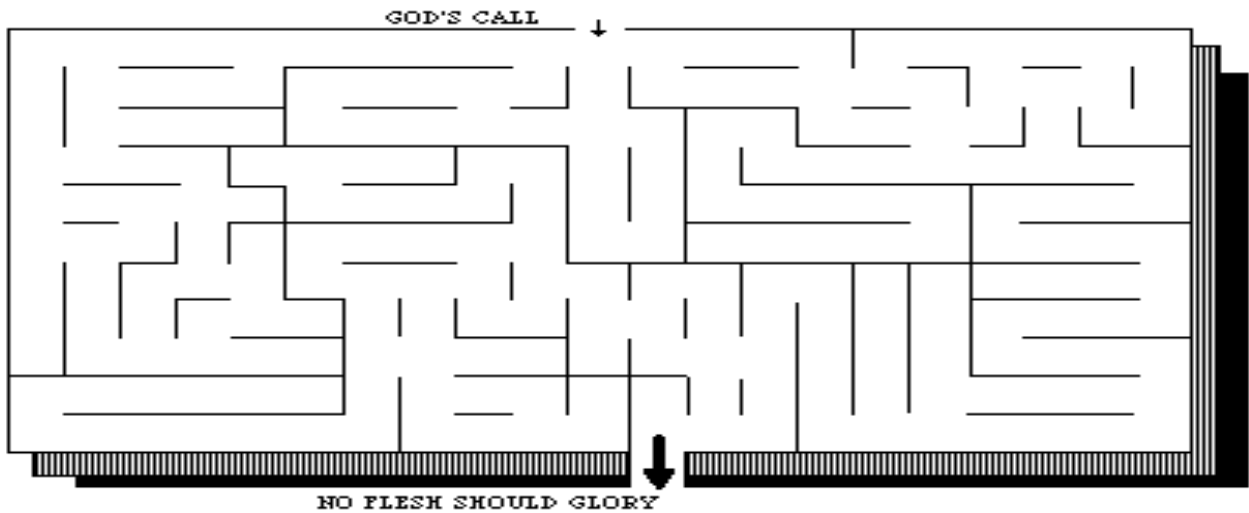

275. God's Call - That No Flesh Should Glory

(1 Corinthians 1:26-30)

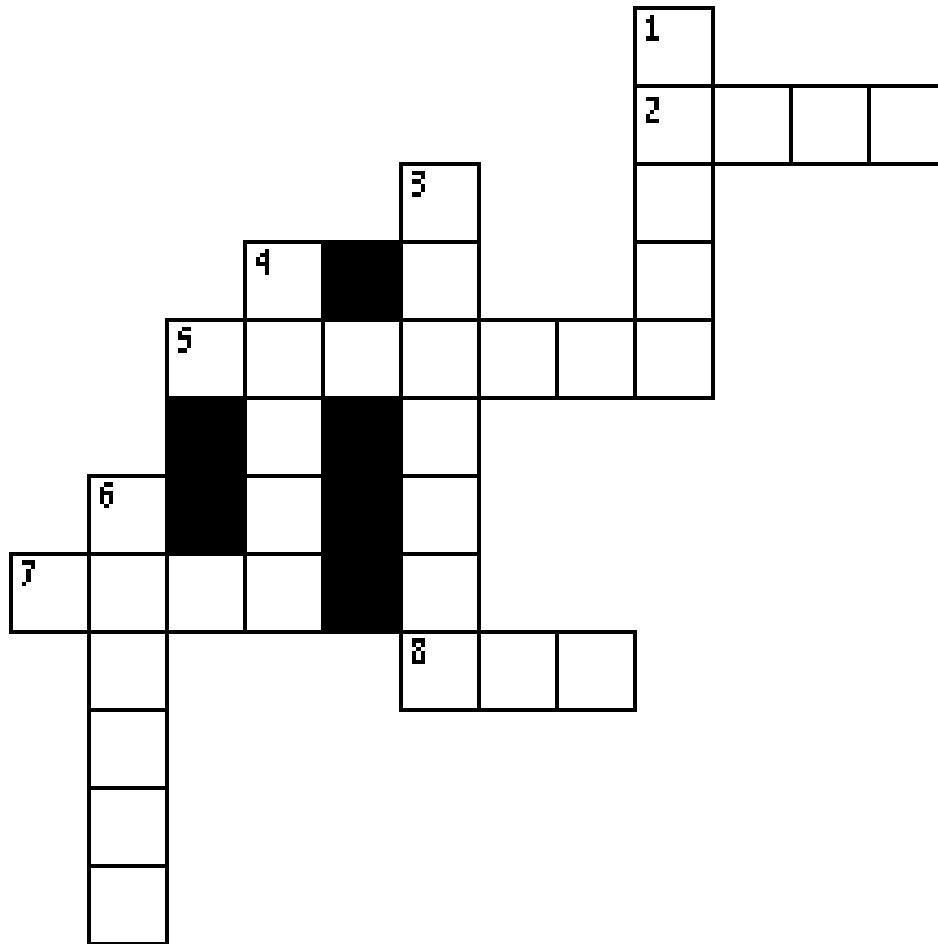

- 3 DOWN "For you see your _____, brethren..." **1 CORINTHIANS 1:26**
- 7 ACROSS "...that not many _____ according to the flesh..." **1 CORINTHIANS 1:26**
- 6 DOWN "...not many _____..." **1 CORINTHIANS 1:26**
- 4 DOWN "...not many _____, are called." **1 CORINTHIANS 1:26**
- 5 ACROSS "God has chosen the _____ things of the world to put to shame the wise." **1 CORINTHIANS 1:27**
- 8 ACROSS "...and the base things of the world and the things which are despised _____ has chosen..."
1 CORINTHIANS 1:28
- 1 DOWN "...that no _____ should glory in His presence." **1 CORINTHIANS 1:29**
- 2 ACROSS "...that, as it is written, 'He who glories, let him glory in the _____.'" **1 CORINTHIANS 1:31**

Bible Story 276

RUNNING THE RACE

1 CORINTHIANS 9:24-27



"Paul asks, ' Do you not know that those who run in a race all run, but one receives the prize?' Then Paul said, 'Run in such a way that you might obtain it.'" *1Corinthians 9:24 – 27*

276. RUNNING THE RACE

(1 CORINTHIANS 9:24-27)

MEMORY VERSE:

"Do you not know that those who run in a race all run, but one receives the prize? Run in such a way that you may obtain it." 1 CORINTHIANS 9:24

CIRCLE THE CORRECT WORD:

1. "Do you not know that those who run in a race all run, but (**ALL**, **ONE**) receives the prize?..."
1 CORINTHIANS 9:24

TRUE OR FALSE:

2. "...Run in such a way that you may obtain it." 1 CORINTHIANS 9:24
TRUE OR FALSE

CIRCLE THE CORRECT WORD:

3. "And everyone who competes for the (**FUN**, **PRIZE**) is temperate in all things..."
1 CORINTHIANS 9:25

TRUE OR FALSE:

4. "...Now they do it to obtain a perishable crown, be we for an imperishable crown."
1 CORINTHIANS 9:25

TRUE OR FALSE

CIRCLE THE CORRECT WORDS:

5. "Therefore I run thus: not with (**CERTAINTY**, **UNCERTAINTY**)..." 1 CORINTHIANS 9:26

6. "...Thus I fight: not as one who beats the (**AIR**, **CARPET**)."
1 CORINTHIANS 9:26

TRUE OR FALSE:

7. "I discipline my body and bring it into subjection..." 1 CORINTHIANS 9:27
TRUE OR FALSE

CIRCLE THE CORRECT WORD:

8. "...lest, when I have preached to others, I myself should become (**QUALIFIED**, **DISQUALIFIED**)."
1 CORINTHIANS 9:27

276. RUNNING THE RACE

(1 CORINTHIANS 9:24-27)

D I S Q U A L I F I E D V J G
B I S E P J K N U I U F S B S
E A S I J E G I W R G Y U R Q
H D M C M Y R H O O M H B U U
T D U S I P P I L W R T T N M
L W B N M P E H S G F C H J J
U T S A G R L R C H O W U H Q
W L C I O K E I I A A U Q T L
Q A O H V P S C N S E B T J J
N O M T S G O J E E H R L Y T
I A P N P P T D O I E A P E W
S P E I T R A R U T V G B R K
V A T R W I I A I K P E P L M
U D E O B Z R C I W K H S D E
U Y S C H E W E B I J B L C L

AIR
COMPETES
CORINTHIANS
CROWN
DISCIPLINE

DISQUALIFIED
FIGHT
IMPERISHABLE
PERISHABLE
PREACH

PRIZE
RACE
RECEIVES
RUN



276. RUNNING THE RACE

(1 CORINTHIANS 9:24-27)

MEMORY VERSE:

"Do you not know that those who run in a race all run, but one receives the prize? Run in such a way that you may obtain it." 1 CORINTHIANS 9:24

FILL IN THE BLANK:

1. "Do you not know that those who run in a race all run, but _____ receives the prize?..."
1 CORINTHIANS 9:24

TRUE OR FALSE:

2. "...Run in such a way that you may obtain it." 1 CORINTHIANS 9:24
TRUE OR FALSE

FILL IN THE BLANK:

3. "And everyone who competes for the _____ is temperate in all things..." 1 CORINTHIANS 9:25

TRUE OR FALSE:

4. "...Now they do it to obtain a perishable crown, be we for an imperishable crown." 1 CORINTHIANS 9:25
TRUE OR FALSE

FILL IN THE BLANKS:

5. "Therefore I run thus: not with _____..." 1 CORINTHIANS 9:26
6. "...Thus I fight: not as one who beats the _____." 1 CORINTHIANS 9:26

TRUE OR FALSE:

7. "I discipline my body and bring it into subjection..." 1 CORINTHIANS 9:27
TRUE OR FALSE

FILL IN THE BLANK:

8. "...lest, when I have preached to others, I myself should become _____."
1 CORINTHIANS 9:27

276. RUNNING THE RACE

(1 CORINTHIANS 9:24-27)

G W M P E W S B R B C A Z B C F N J J R
N I U H E T D L D I S C I P L I N E E E
W O O N M R A M E C A R I B R D I C O Y
B V B N P S I R O E J Y J R K Q E C I Y
W M M V E E Q S E Q C B Z B G I D A M S
R I A G O L H D H P I O T Q V N L S C Q
B G G R B B E E E A M C M E W N G O U K
V D Q K T A N J N I B E S P T F R B Z Y
B O O Z A H P R U N F L T K E I R W D J
H T T L I S T L T A T I E L N T A D C P
C P H B N I L D V L B M L T D Y E I A A
O R K I I R Z Z B B I U H A C V F S B V
Y I W V P E T P K F U I P E U Y W A F T
K Z W V L P T E C H A A T R V Q V J L P
E E B T E M B B E N K K I S E B S T I C
O C L L P I S L S V B I J Z S A B I R G
J U R C K C M I U E B L I R B F C O D F
S V Q M S T H A Z L F O J L K P W H H K
Z N C G N P V I F I G H T B Y N Q L V K
N V R K U M Y S U B J E C T I O N N M O

AIR
COMPETES
CORINTHIANS
CROWN
DISCIPLINE
DISQUALIFIED

FIGHT
IMPERISHABLE
OBTAIN
PERISHABLE
PREACH
PRIZE

RACE
RECEIVES
RUN
SUBJECTION
TEMPERATE

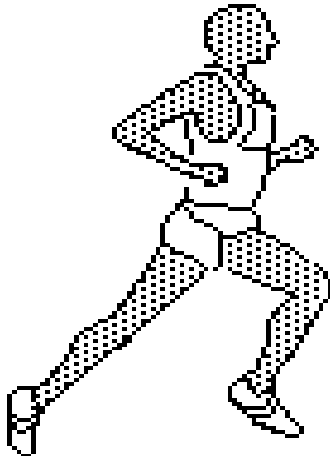

276. RUNNING THE RACE

(1 CORINTHIANS 9:24-27)

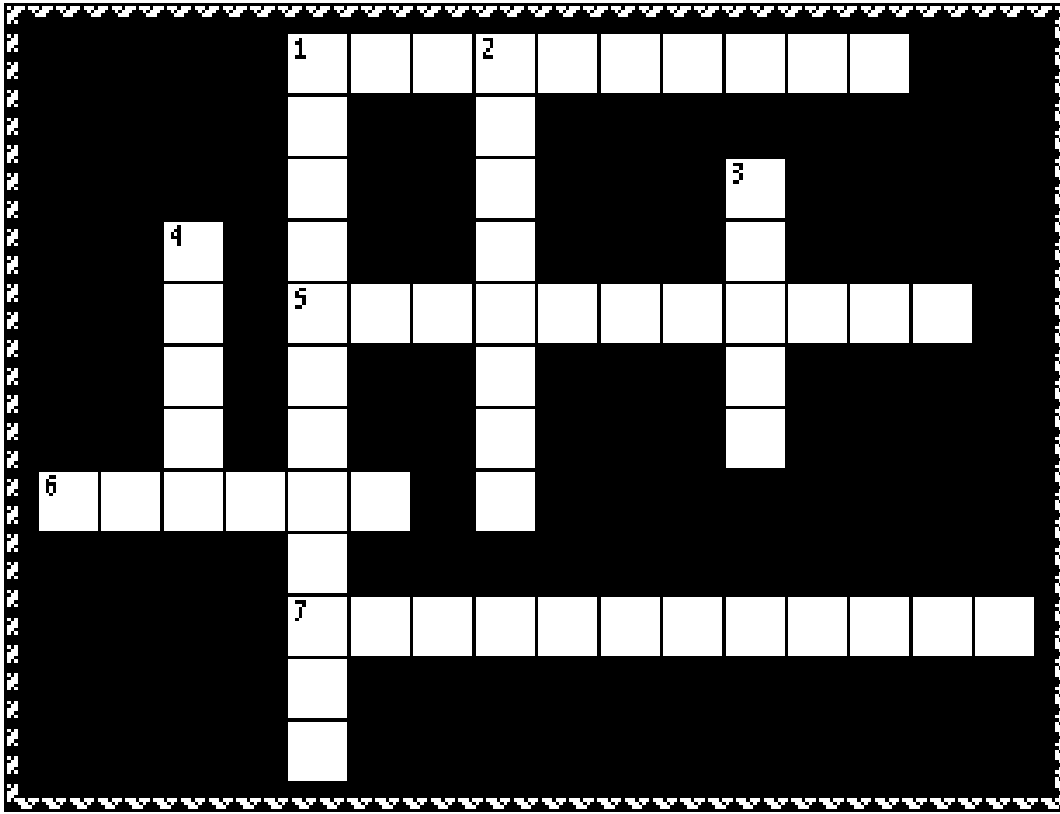

- 3 DOWN "Do you not know that those who run in a race all run, but one receives the ____?..."
1 CORINTHIANS 9:24
- 6 ACROSS "...Run in such a way that you may ____ it." **1 CORINTHIANS 9:24**
- 2 DOWN "And everyone who ____ for the prize is temperate in all things..."
1 CORINTHIANS 9:25
- 7 ACROSS "...Now they do it to obtain a perishable crown, be we for an ____ crown."
1 CORINTHIANS 9:25
- 5 ACROSS "Therefore I run thus: not with ____..." **1 CORINTHIANS 9:26**
- 4 DOWN "...Thus I ____: not as one who beats the air." **1 CORINTHIANS 9:26**
- 1 ACROSS "I ____ my body and bring it into subjection..." **1 CORINTHIANS 9:27**
- 1 DOWN "...lest, when I have preached to others, I myself should become ____."
1 CORINTHIANS 9:27

Bible Story 277

SPIRITUAL GIFTS

1 CORINTHIANS 12:1-31; 14:1-40



"I will pray with the spirit, and I will also pray with understanding. I will sing with the spirit, and I will also sing with understanding." *1 Corinthians 14:15*

277. SPIRITUAL GIFTS

(1 CORINTHIANS 12:1-31; 14:1-40)

MEMORY VERSE:

"But one and the same Spirit works all these things, distributing to each one individually as He wills. For as the body is one and has many members, but all the members of that one body, being many, are one body, so also is Christ." 1 CORINTHIANS 12:11-12

Paul writes to the Corinthians... "Now concerning spiritual gifts, brethren, I do not want you to be ignorant:" 1 CORINTHIANS 12:1

TRUE OR FALSE:

1. "Now there are diversities of gifts, but the same Spirit." 1 CORINTHIANS 12:4
TRUE OR FALSE
2. "There are differences of ministries, but the same Lord." 1 CORINTHIANS 12:5
TRUE OR FALSE
3. "And there are diversities of activities, but it is the same God who works all in all." 1 CORINTHIANS 12:6
TRUE OR FALSE

CIRCLE THE CORRECT WORDS:

4. "...for to one is given the word of (**WISDOM, FOOLISHNESS**) through the Spirit, to another the word of (**KNOWLEDGE, IGNORANCE**) through the same Spirit." 1 CORINTHIANS 12:8
5. "...to another (**FAITH, FEAR**) by the same Spirit, to another gifts of (**HEALING, FEELINGS**) by the same Spirit." 1 CORINTHIANS 12:9

TRUE OR FALSE:

6. "...to another the working of miracles, to another prophecy, to another discerning spirits, to another different kinds of tongues, to another the interpretation of tongues." 1 CORINTHIANS 12:10
TRUE OR FALSE
7. "But one and the same Spirit works all these things, distributing to each one individually as He wills." 1 CORINTHIANS 12:11
TRUE OR FALSE
8. "For the body is one and has many members, but all the members of that one body, being many, are one body, so also is Christ." 1 CORINTHIANS 12:12
TRUE OR FALSE
9. "And if one member suffers, all the members suffer with it; or if one member is honored, all the members rejoice with it." 1 CORINTHIANS 12:26
TRUE OR FALSE

277. SPIRITUAL GIFTS

(1 CORINTHIANS 12:1-31; 14:1-40)

N T I F O R P S K J A S V J E
 S N Z L H T N G K T N T M J U
 Z G I N P Y M D Q E R F A E W
 K H O P E L G E S J P A Z A D
 E B S R E B M E M U B O D Y W
 B D V V J I F P J Z S Y S W Y
 F G I Q T O H Z B Z I E H L P
 A R V F B V A C B K Q Y J Z Z
 I S T F I G L A U T I R I P S
 T Q B T I E W C R C D O M B W
 H I Q A A Q S Q B T J F B P B
 Z P Y Q M Z B I K I Q V S J M
 H O L Y S P I R I T R D O G W
 F H E F B U P W E O I B V H U
 H E V O L A E Z F T L S O G F

BODY
 LOVE
 GOD
 SPIRITUAL GIFTS

JESUS
 FAITH
 PROFIT
 HOPE

EDIFIES
 MEMBERS
 HOLY SPIRIT



277. SPIRITUAL GIFTS

(1 CORINTHIANS 12:1-31; 14:1-40)

MEMORY VERSE:

"But one and the same Spirit works all these things, distributing to each one individually as He wills. For as the body is one and has many members, but all the members of that one body, being many, are one body, so also is Christ." 1 CORINTHIANS 12:11-12

Paul writes to the Corinthians... "Now concerning spiritual gifts, brethren, I do not want you to be ignorant:" 1 CORINTHIANS 12:1

TRUE OR FALSE:

1. "Now there are diversities of gifts, but the same Spirit." 1 CORINTHIANS 12:4
TRUE OR FALSE
2. "There are differences of ministries, but the same Lord." 1 CORINTHIANS 12:5
TRUE OR FALSE
3. "And there are diversities of activities, but it is the same God who works all in all." 1 CORINTHIANS 12:6
TRUE OR FALSE

CIRCLE ALL OF THE CORRECT WORDS:

4. In 1 Corinthians 12:8-10 Paul lists gifts of the Spirit. Circle them below.

WORD OF WISDOM

WORD OF KNOWLEDGE

FAITH

GREED

HEALINGS

MIRACLES

PROPHECY

PRIDE

DISCERNING OF SPIRITS

TONGUES

INTERPRETATION OF TONGUES

FOOLISHNESS

TRUE OR FALSE:

5. "But one and the same Spirit works all these things, distributing to each one individually as He wills." 1 CORINTHIANS 12:11
TRUE OR FALSE
6. "For the body is one and has many members, but all the members of that one body, being many, are one body, so also is Christ." 1 CORINTHIANS 12:12
TRUE OR FALSE
7. "And if one member suffers, all the members suffer with it; or if one member is honored, all the members rejoice with it." 1 CORINTHIANS 12:26
TRUE OR FALSE
8. Let nothing be done decently and in order. 1 CORINTHIANS 14:40
TRUE OR FALSE

277. SPIRITUAL GIFTS

(1 CORINTHIANS 12:1-31; 14:1-40)

S P I R I T U A L G I F T S F I V P F A
 T E A C H E R S P R O P H E T S R A D T
 F B W H G A F N S P W D P S S O I M B O
 O T J W V F Z V B Z K R S E F T I D Z Y
 R H T E K W A A Q I O E L I H N W G O Y
 U J N I S E P O B P U T T Z I Z O U E G
 A M E N C U B W H G S M B S T C R A H S
 M U M T U J S E N O E O T I I G D R O E
 D N N E E N C O P M D R S L N F O O L I
 N H R R T Y T A B Y A E C Y W M F K Y R
 A E E P N Q B E M T L B Q R S T K M S T
 T L C R R A R E I C O K U L E O N N P S
 S P S E W S R O A C W S W P I I O H I I
 R S I T I B N R I B F L B F F O W Y R N
 E N D A S S I T T K U Z Q S I M L M I I
 D R K T D M Z E N L A I B T D C E V T M
 E S G I O M F P B W H C A B E O D V W P
 P C Q O M M I C P F O D F C D W G B B C
 O R N N G J A V S G N I L A E H E B T F
 H G G Z Q L B T Y I L O V E T L A B S N

ADMINISTRATIONS
 APOSTLES
 BODY
 DISCERNMENT
 EDIFIES
 FAITH
 GOD

HEALINGS
 HELPS
 HOLY SPIRIT
 INTERPRETATION
 JESUS
 LOVE
 HOPE

MEMBERS
 MINISTRIES
 MIRACLES
 PROFIT
 PROPHECY
 PROPHETS

SPIRITUAL GIFTS
 TEACHERS
 TONGUES
 UNDERSTAND
 WISDOM
 WORD OF KNOWLEDGE

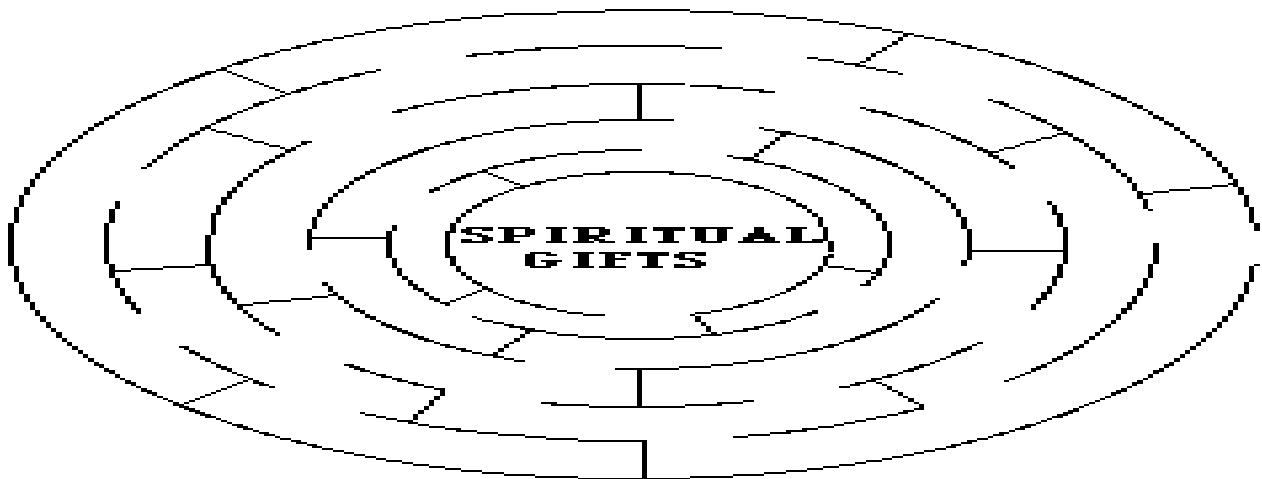

277.SPIRITUAL GIFTS

(1 CORINTHIANS 12:1-31; 14:1-40)

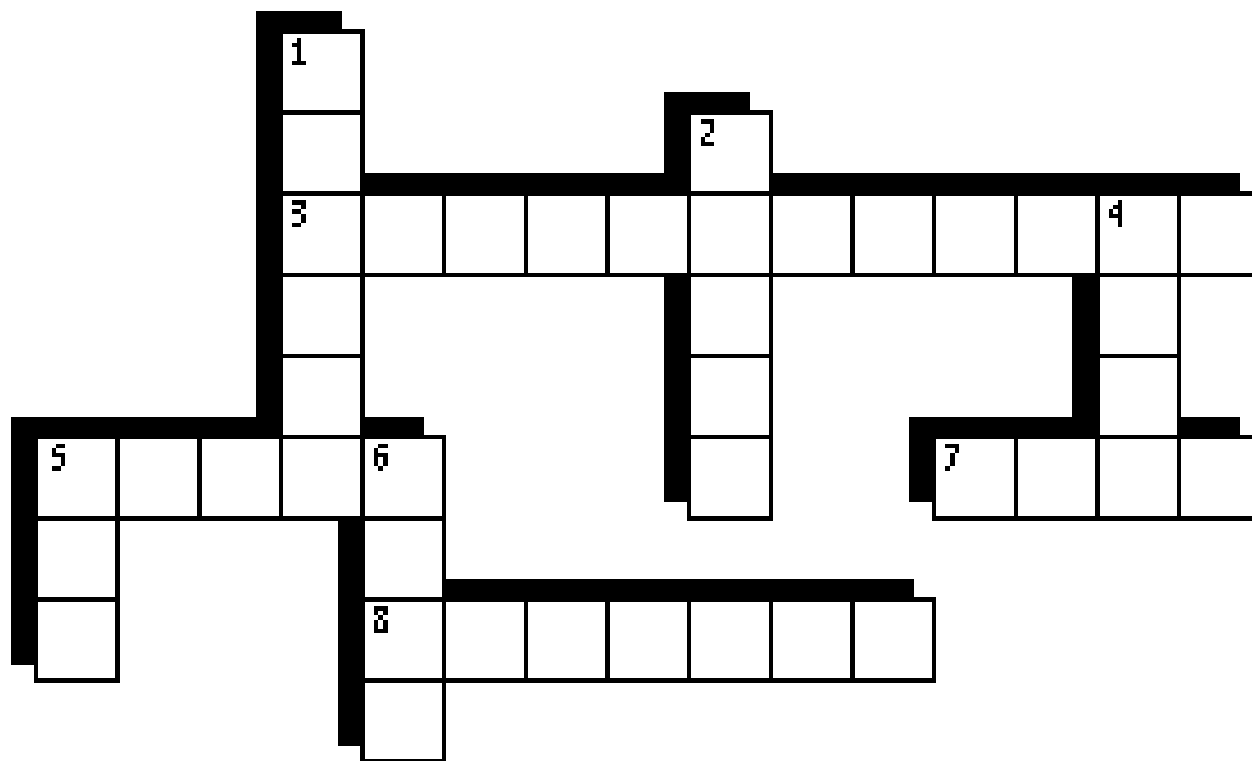

- 5 ACROSS "Now concerning spiritual _____, brethren, I do not want you to be ignorant:"
1 CORINTHIANS 12:1
- 1 DOWN "Now there are diversities of gifts, but the same _____." **1 CORINTHIANS 12:4**
- 4 DOWN "There are differences of ministries, but the same _____." **1 CORINTHIANS 12:5**
- 5 DOWN "And there are diversities of activities, but it is the same _____ who works all in all."
1 CORINTHIANS 12:6
- 2 DOWN "...for to one is _____ the word of wisdom through the Spirit, to another the word of knowledge through the same Spirit." **1 CORINTHIANS 12:8**
- 6 DOWN "...to another faith by the same Spirit, to another gifts of healing by the _____ Spirit."
1 CORINTHIANS 12:9
- 3 ACROSS "But one and the same Spirit works all these things, distributing to each one _____ as He wills."
1 CORINTHIANS 12:11
- 7 ACROSS "For the body is one and has many members, but all the members of that one body, being many, are one _____, so also is Christ." **1 CORINTHIANS 12:12**
- 8 ACROSS "And if one member suffers, all the members suffer with it; or if one member is honored, all the _____ rejoice with it." **1 CORINTHIANS 12:26**

Bible Story 278

THE GIFT OF LOVE

1 CORINTHIANS 13:1-13

278. THE GIFT OF LOVE
(1 CORINTHIANS 13:1-13)



"And now abide faith, hope, love, these three; but the greatest of these is love."
1 CORINTHIANS 13:13

278. THE GIFT OF LOVE

(1 CORINTHIANS 13:1-13)

MEMORY VERSE:

"And now abide faith, hope, love, these three; but the greatest of these is love."

1 CORINTHIANS 13:13

TRUE OR FALSE: 1 CORINTHIANS 13

I or F

VS. 4 Love suffers long and is kind.

VS. 4 Love does not envy.

VS. 4 Love does not parade itself.

VS. 4 Love is puffed up.

VS. 5 Love behaves rudely.

VS. 5 Love does not seek its own.

VS. 5 Love is not provoked.

VS. 5 Love thinks no evil.

VS. 6 Love rejoices in iniquity.

VS. 6 Love rejoices in truth.

VS. 7 Love bears nothing.

VS. 7 Love believes all things.

VS. 7 Love hopes all things.

VS. 7 Love endures all things.

VS. 8 Love never fails.

278. THE GIFT OF LOVE

(1 CORINTHIANS 13:1-13)

H O P E S R A E B W U K W S L
U O E T S P M O U N T A I N S
A G J F K E I U O G M L O V E
D A N W A S C T O N G U E S J
B P D I P C M I U T F J U U B
R A M N H O E I O D L I H C J
A D S B I T T T R J O F G B P
S Y B L U K O S O R E Y H O H
S S G O E R H N E F O R O H H
D S U B D G N O I T A R W U T
W M O F G Y N E I T A C V Q I
T U V H F T E A D K R E E T A
L B S J K E J P B W N U R P F
C Y M B A L R L O I E E T G T
A S P Y G W D S R H P T M H J

ANGELS
BEARS
BODY
BRASS
BURNED
CHILD

CYMBAL
FACE TO FACE
FAITH
GREATEST
HOPE
HOPES

KIND
LOVE
MEN
MIRROR
MOUNTAINS
NOTHING

POOR
REJOICES
SUFFERS
TONGUES
TRUTH

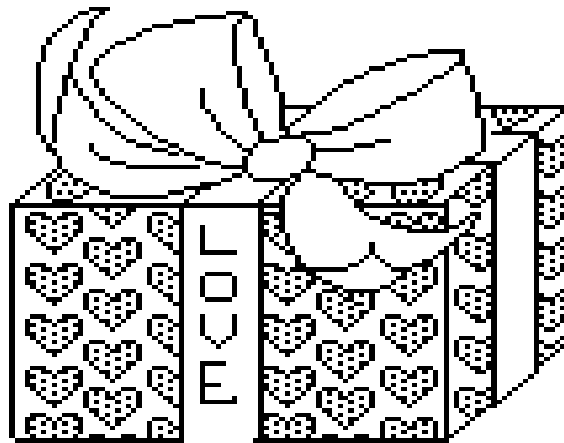

278. THE GIFT OF LOVE

(1 CORINTHIANS 13:1-13)

MEMORY VERSE:

"And now abide faith, hope, love, these three; but the greatest of these is love."

1 CORINTHIANS 13:13

FILL IN THE BLANKS:

1 CORINTHIANS 13

VS. 4 Love _____ long and is kind.

VS. 4 Love does _____ envy.

VS. 4 Love does not _____ itself.

VS. 4 Love is not _____ up.

VS. 5 Love does not behave _____.

VS. 5 Love does not _____ its own.

VS. 5 Love is _____ provoked.

VS. 5 Love _____ no evil.

VS. 6 Love does not rejoice in _____.

VS. 6 Love rejoices in _____.

VS. 7 Love bears _____ things.

VS. 7 Love believes _____ things.

VS. 7 Love hopes _____ things.

VS. 7 Love endures _____ things.

VS. 8 Love _____ fails.

278. THE GIFT OF LOVE

(1 CORINTHIANS 13:1-13)

I L S M V I U R S F K H U G B J V L B L O V W A C
 O N H E N F I Y T L H M E N V H Q B K Y Y W W Y G
 B D U T P B P R V K O Y I Q D N O R L T T A M Z U
 K C S L Y L N E G I P G B W I F V O D P T B V Y K
 E V Y M G B S X W Q E M Q G M G Y W O V A T H E J
 Y O J E U A C V E C I O J E R I G H H L S Z W K W
 T S S R A E B T D T R U T H O R B J Y E U V S G S
 E K N Z N E N S K S R B B B E E F S Q N F B R Z F
 Z E N I S Z P O N S E U V A O A C R K J F B V S Z
 D L D I E C C J S I N V T W I G J V G A E M B B Z
 Q D Y D U L B Q E O A E B T F W N J O H R S K E E
 V F I Z G W C L P E S T H D U B B D J N S H G W S
 L A B P N C B P O T A E N I D O L U M Y G J P G G
 S B L Z O A P V H Z I Z W U I I L V N W D L E B Y
 R R O V T Z R G A P P U Y C O L D C R C L B I T M
 S B U U W S E Y G E Q E U P V M N G M N I B N D X
 A N G E L S S R S U F C B L E D K N O T H I N G O
 B E P D Y S M Q O V R A Y O M S A O I R C B A P L
 B W W W A D H D A O C F H P N U U Q F G F N V T F
 R G C R Z G Y O U F P O F D B J W A J I I P I C L
 Z O B E U P Y O B I G T K Q A L K E Q K Y F W P O
 F F R E G C M O K U O E Q I S J Y G E F M H A N V
 W Z P R F V D K S H W C B J N T Y A P T R J M B E
 B A R B I Y B P Y I J A H J P D E T G S A K H I W
 Y N F D Y M P Z B P V F M C W B H N G T U Z L V U

ANGELS
 BEARS
 BODY
 BRASS
 BURNED
 CHILD

CYMBAL
 FACE TO FACE
 FAITH
 GREATEST
 HOPE
 HOPES

KIND
 LOVE
 MEN
 MIRROR
 MOUNTAINS
 NOTHING

POOR
 REJOICE
 SUFFERS
 TONGUES
 TRUTH

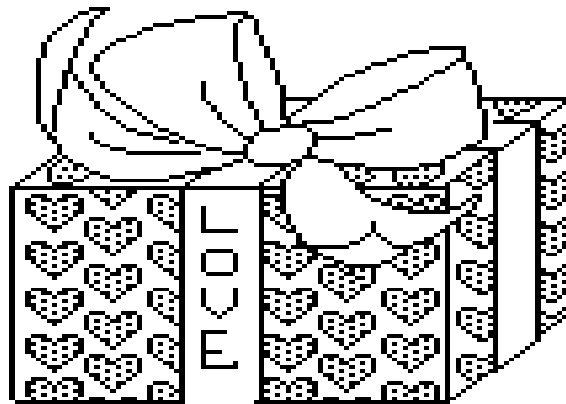

278. THE GIFT OF LOVE

(1 CORINTHIANS 13:1-13)

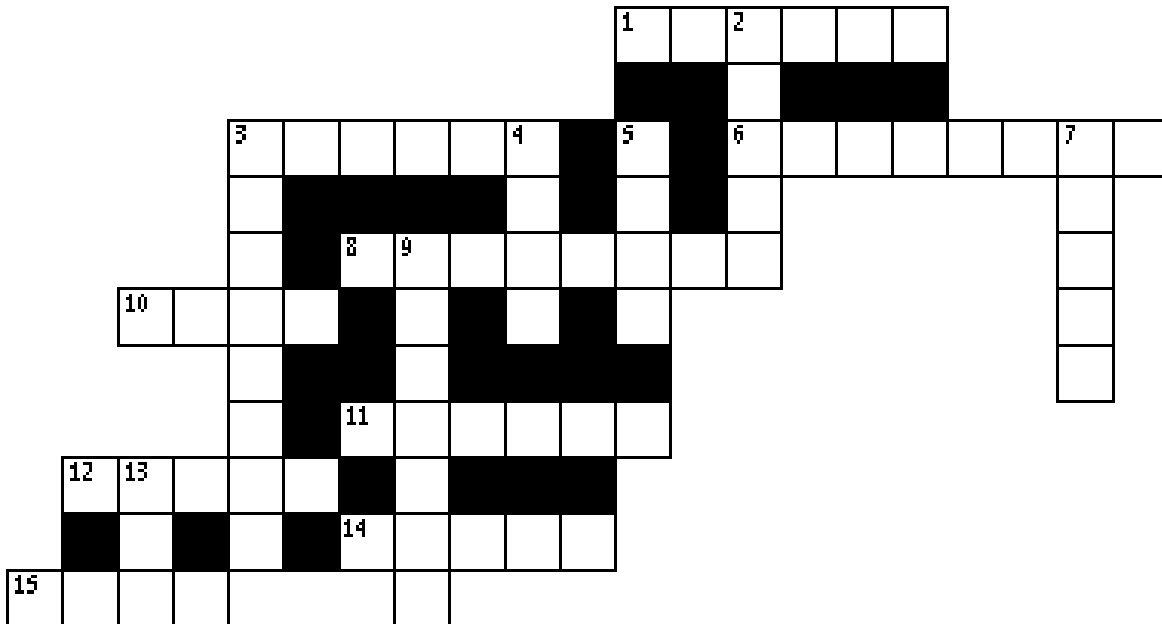

- 15 ACROSS "Love suffers long and is ____." 1 CORINTHIANS 13:4
- 5 DOWN "Love does not ____." 1 CORINTHIANS 13:4
- 3 ACROSS "Love does not ____ itself." 1 CORINTHIANS 13:4
- 1 ACROSS "Love is not ____ up." 1 CORINTHIANS 13:4
- 11 ACROSS Love "does not behave ____." 1 CORINTHIANS 13:5
- 13 DOWN Love "does not seek its ____." 1 CORINTHIANS 13:5
- 3 DOWN Love "is not ____." 1 CORINTHIANS 13:5
- 4 DOWN Love "thinks no ____." 1 CORINTHIANS 13:5
- 6 ACROSS Love "does not rejoice in ____." 1 CORINTHIANS 13:6
- 7 DOWN Love "rejoices in the ____." 1 CORINTHIANS 13:6
- 14 ACROSS Love "____ all things." 1 CORINTHIANS 13:7
- 8 ACROSS Love "____ all things." 1 CORINTHIANS 13:7
- 12 ACROSS Love "____ all things." 1 CORINTHIANS 13:7
- 9 DOWN Love "____ all things." 1 CORINTHIANS 13:7
- 2 DOWN "Love never ____." 1 CORINTHIANS 13:8
- 10 ACROSS "And now abide faith, hope, love, these three; but the greatest of these is ____."
1 CORINTHIANS 13:13

Bible Story 279

OUR GLORIOUS NEW BODIES

1 CORINTHIANS 15:35-57

279. OUR GLORIOUS NEW BODIES

(1 CORINTHIANS 15:35-57)

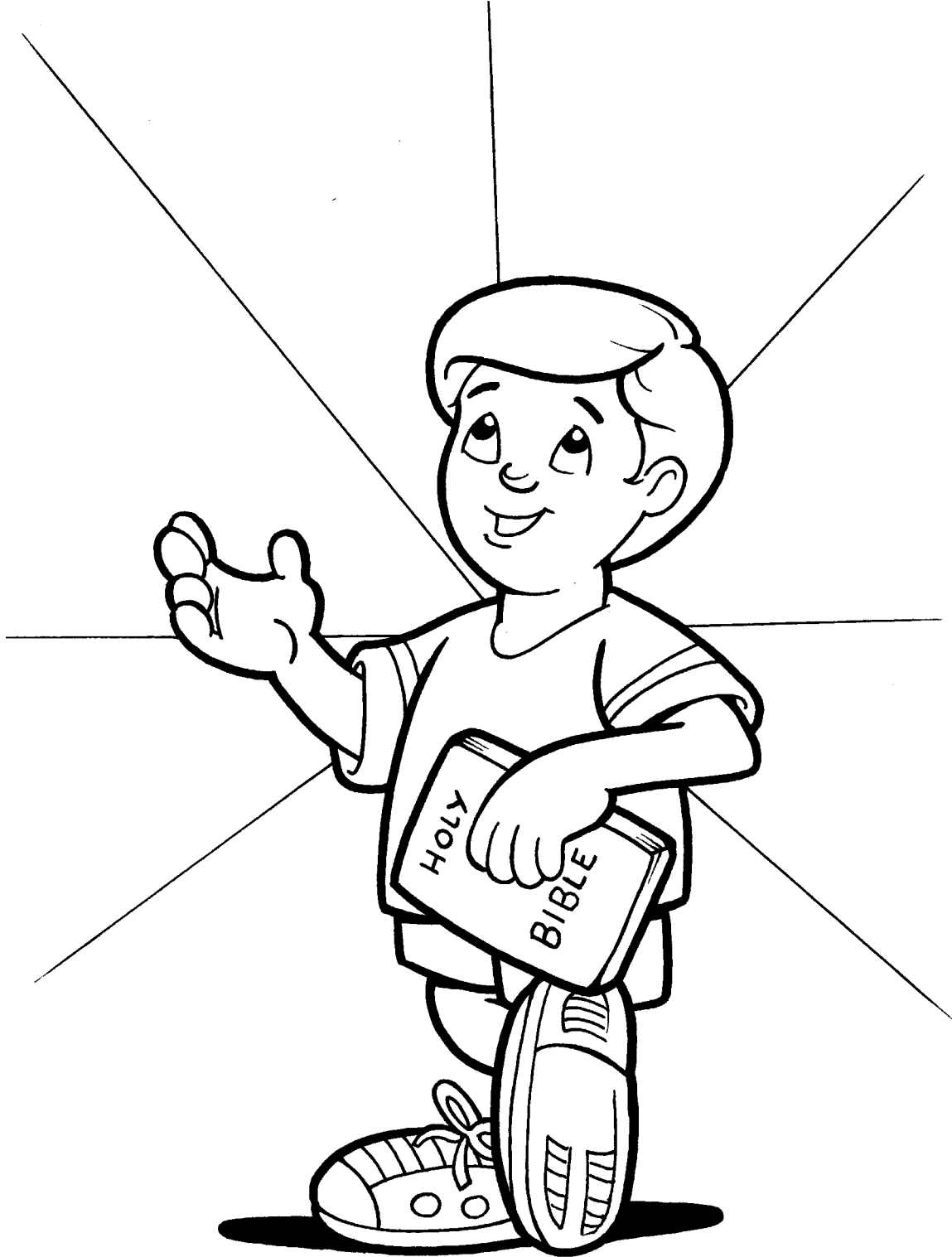

"In a moment, in the twinkling of an eye, at the last trump: for the trumpet shall sound, and the dead shall be raised incorruptible, and we shall be changed. For this corruptible must put on incorruption, and this mortal *must* put on immortality."

1 CORINTHIANS 15:52-53

279. OUR GLORIOUS NEW BODIES

(1 CORINTHIANS 15:35-57)

MEMORY VERSE:

"And as we have borne the image of the man of dust, we shall also bear the image of the heavenly Man." 1 CORINTHIANS 15:49

TRUE OR FALSE:

1. "There are also celestial bodies and terrestrial bodies; but the glory of the celestial is one, and the glory of the terrestrial is another." 1 CORINTHIANS 15:40

TRUE OR FALSE

2. "...The body is sown in corruption, it is raised in incorruption." 1 CORINTHIANS 15:42 _____

"It is sown in dishonor, it is raised in glory..." 1 CORINTHIANS 15:43 _____

...It is sown in weakness, it is raised in weakness. 1 CORINTHIANS 15:43 _____

"It is sown a natural body, it is raised a spiritual body..." 1 CORINTHIANS 15:44 _____

"...There is a natural body, and there is a spiritual body." 1 CORINTHIANS 15:44 _____

UNDERLINE THE CORRECT ANSWER:

3. "And so it is written, 'The first man Adam became a living being.' The last Adam became _____." 1 CORINTHIANS 15:45

- a. the last living being
b. a life-giving spirit

CIRCLE THE CORRECT WORDS:

4. "And as we have borne the image of the man of dust, we shall also bear the image of the (EARTHLY, HEAVENLY) man." 1 CORINTHIANS 15:49

5. "Behold, I tell you a mystery: We shall not all sleep, but we shall all be (CHANGED, SLEEPY)- in a moment, in the twinkling of an eye, at the last trumpet. For the trumpet will sound, and the dead will be raised incorruptible, and we shall be changed." 1 CORINTHIANS 15:51-52

6. "But thanks be to (GOD, MEN), who gives us the victory through our Lord Jesus Christ."

279. OUR GLORIOUS NEW BODIES

(1 CORINTHIANS 15:35-57)

K I N G D O M O F G O D U S T
 I T V R W I U G O Z U L P E V
 C S W R E E B P V B H A S L M
 C M Z I E W A H N Y S R P I Y
 A K Y G N S O K J A E U I V R
 D I E N I K U P N E L T R I O
 A R H I M T L R L E F A I N L
 M K H V A F R I R M S N T G G
 M Q E I G L D U N E I S U C T
 R Y A G E O W K M G C L A H Q
 B C V E G B W O D P J T L M V
 G Z E F C K V H S B E M I B U
 B A N I M Y S T E R Y T B O G
 I K L L S M D E G N A H C I N
 V R Y Z G I K C R Z B O D Y B

ADAM
 BODY
 CHANGED
 DUST
 FLESH
 GLORY

GOD
 HEAVENLY
 IMAGE
 KINGDOM OF GOD
 LIFE-GIVING

LIVING
 MYSTERY
 NATURAL
 POWER
 RESURRECTION

SOW
 SPIRITUAL
 TRUMPET
 TWINKLING
 WEAKNESS

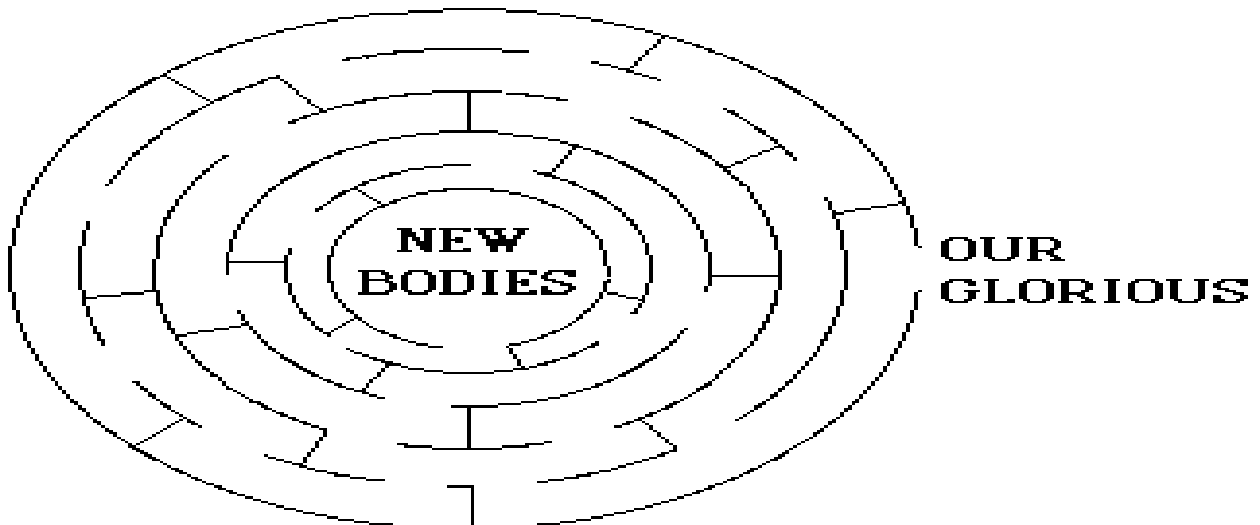

279. OUR GLORIOUS NEW BODIES

(1 CORINTHIANS 15:35-57)

MEMORY VERSE:

"And as we have borne the image of the man of dust, we shall also bear the image of the heavenly Man." 1 CORINTHIANS 15:49

TRUE OR FALSE:

1. "There are also celestial bodies and terrestrial bodies; but the glory of the celestial is one, and the glory of the terrestrial is another." 1 CORINTHIANS 15:40

TRUE OR FALSE

FILL IN THE BLANKS:

2. "...The body is sown in corruption, it is raised in _____." 1 CORINTHIANS 15:42

"It is sown in dishonor, it is raised in _____." 1 CORINTHIANS 15:43

"...It is sown in weakness, it is raised in _____." 1 CORINTHIANS 15:43

"It is sown a natural body, it is raised a _____ body..." 1 CORINTHIANS 15:44

TRUE OR FALSE:

"...There is a natural body, and there is a spiritual body." 1 CORINTHIANS 15:44

TRUE OR FALSE

UNDERLINE THE CORRECT ANSWER:

3. "And so it is written, 'The first man Adam became a living being.' The last Adam became _____." 1 CORINTHIANS 15:45

- a. the last living being
- b. a life-giving spirit

FILL IN THE BLANKS:

4. "And as we have borne the image of the man of dust, we shall also bear the image of the _____ man." 1 CORINTHIANS 15:49

5. "Behold, I tell you a mystery: We shall not all sleep, but we shall all be _____ - in a moment, in the twinkling of an eye, at the last trumpet. For the trumpet will sound, and the dead will be raised incorruptible, and we shall be changed." 1 CORINTHIANS 15:51-52

6. "But thanks be to _____, who gives us the victory through our Lord Jesus Christ."

279. OUR GLORIOUS NEW BODIES

(1 CORINTHIANS 15:35-57)

T Y B B P W Z F A D Y W N P A M G J T F R F T G I A N P J B
 I A N O I T P U R R O C O C V P A M E S N D O M P F B G D K
 O O D D G J Y S R D D L B D B O M V U A Y H Y R E T S Y M M
 T F P A K U N W L O J A U T O E M S S G M D N B O I V G H I
 A V J R M K J U W K I P L B U A A P S G Z F K T R M I Z R J
 N B H C B O T H S E L F P B V Y O I O Q N W V L A I U A T M
 R S C H A N G E D Q P P M G Z U K R F W U I E A V O S B K S
 P V G G U I P D J K T A C E A H C I J F E Y V B K Q S K R B
 I M E R L A I R T S E R R E T A Y T S H I R F I R H A O B V
 Q A U G K T L S U L V B C I U E U U G W K S G H G U L M W M
 D Z W N C E T J O W R V V K E C D A R U N H S P W E Y Y U H
 J B D G U S J S E K F Q Z B F N Y L A I M E L U Y N F S E Z
 Q O W Z O J C H U I E D K P P A G W S K C A C V B H J I E D
 T D Y W M K V Q P D J V F P T R T Z F E D V Y L G P H G L O
 W Y P J D K T O T J O S K B O I E F N Y N E D R P U W U O G
 I S Z P L P W E C S U M S Z N Z I S T B Y N T R F Y Z I Z I
 N H N O I T P U R R O C N I I S I I U T J L L E Q N A S N K
 K M W N S Z H W S U G C M V J N P Z Q R D Y V V K M P C K Q
 L B B E G A M I L A R U T A N C G T C I R K P U G H B T K P
 I S M U V Y P E C E F Z O F J Z C M D O V E T V B B I E J T
 N V W O R Y J B H A K L A R Y B J G Y W C T C P Q Y C K H J
 G O U F C O H K U V L U T K T R N G R A U E J T L A N E R L
 R J F L M J Q S E D D A M K H P H R Q E A F I I I O Z O R G
 I J I L L F O U C Q B T I Y G J E H T P U Y P R J O F E I B
 L K I N G D O M O F G O D T F P D U B Q T R K F V M N N S V
 S E P M B A A H N E K M Z R S Q B V K T E N D T E P M U R T
 T A G S B H W P Q N K O J G Y E Y Y I F K L A V U B N S H C
 F W Y Z A A V E L R A E S I Q B L Y J V O M Y Q B H F M J I
 A L P S S E N K A E W M M K D Q K E E I O A L I V I N G G C
 Y Z Y F C H M V K Y T B B U C B K R C F P B S B E G L O R Y

ADAM
 BODY
 CELESTIAL
 CHANGED
 CORRUPTION
 DUST
 FLESH

GLORY
 GOD
 HEAVENLY
 IMAGE
 INCORRUPTION
 KINGDOM OF GOD

LIFE-GIVING
 LIVING
 MYSTERY
 NATURAL
 POWER
 RESURRECTION

SOW
 SPIRITUAL
 TERRESTRIAL
 TRUMPET
 TWINKLING
 WEAKNESS

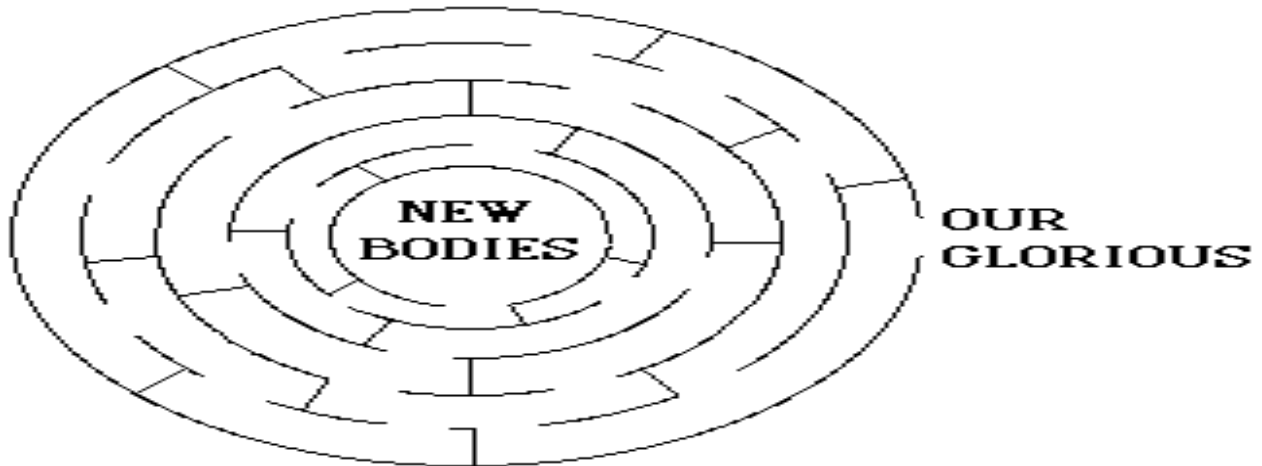

279. OUR GLORIOUS NEW BODIES

(1 CORINTHIANS 15:35-57)

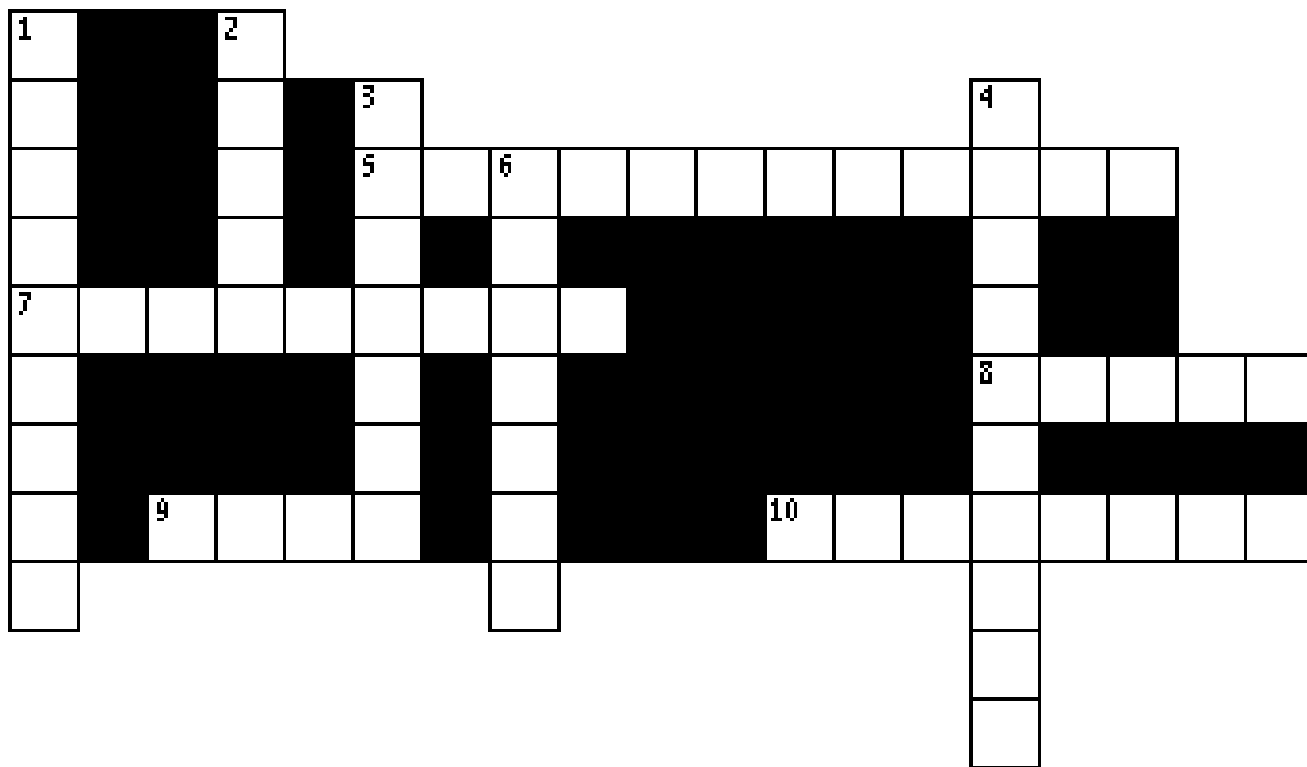

- 1 DOWN "There are also ____ bodies and terrestrial bodies; but the glory of the celestial is one, and the glory of the terrestrial is another." **1 CORINTHIANS 15:40**
- 5 ACROSS "...The body is sown in corruption, it is raised in ____." **1 CORINTHIANS 15:42**
- 8 ACROSS "It is sown in dishonor, it is raised in ____..." **1 CORINTHIANS 15:43**
- 2 DOWN "...It is sown in weakness, it is raised in ____." **1 CORINTHIANS 15:43**
- 9 ACROSS "It is sown a natural body, it is raised a spiritual ____..." **1 CORINTHIANS 15:44**
- 7 ACROSS "...There is a natural body, and there is a ____ body." **1 CORINTHIANS 15:44**
- 4 DOWN "And so it is written, 'The first man Adam became a living being.' The last Adam became a ____-____ spirit." **1 CORINTHIANS 15:45**
- 10 ACROSS "And as we have borne the image of the man of dust, we shall also bear the image of the ____ man." **1 CORINTHIANS 15:49**
- 6 DOWN "Behold, I tell you a mystery: We shall not all sleep, but we shall all be changed.- in a moment, in the twinkling of an eye, at the last trumpet. For the trumpet will sound, and the dead will be raised incorruptible, and we shall be ____" **1 CORINTHIANS 15:51-52**
- 3 DOWN "But thanks be to God, who gives us the ____ through our Lord Jesus Christ." **1 CORINTHIANS 15:57**

Bible Story 280

**IN CHRIST
WE ARE A
NEW CREATION**

2 CORINTHIANS 5:14-21

280. IN CHRIST, WE ARE A NEW CREATION
(2 CORINTHIANS 5:14-21)



"Therefore if anyone is in Christ, he is a new creation; old things have passed away;
behold, all things have become new."

2 CORINTHIANS 5:17

280. IN CHRIST, WE ARE A NEW CREATION (2 CORINTHIANS 5:14-21)

MEMORY VERSE:

"Therefore if anyone is in Christ, he is a new creation; old things have passed away; behold, all things have become new." 2 CORINTHIANS 5:17

"For the love of God constrains us, because we judge thus..."

TRUE OR FALSE:

1. "...That if One died for all, then all died." **2 CORINTHIANS 5:14**
TRUE OR FALSE
2. "And He died for all, that those who live should no longer live for themselves, but for Him who died for them and rose again." **2 CORINTHIANS 5:15**
TRUE OR FALSE

CIRCLE THE CORRECT WORD:

3. "If anyone is in Christ, he is a new creation; old things have passed away; behold, (ALL, SOME) things have become new." **2 CORINTHIANS 5:17**

TRUE OR FALSE:

4. "...God was in Christ reconciling the world to Himself..." **2 CORINTHIANS 5:19**
TRUE OR FALSE

CIRCLE THE CORRECT WORD:

5. "Therefore we are ambassadors for (ISRAEL, CHRIST), as though God were pleading through us: we implore you on Christ's behalf, be reconciled to God." **2 CORINTHIANS 5:20**

TRUE OR FALSE:

6. "For He made Him who knew no sin to be sin for us, that we might become the righteousness of God in Him." **2 CORINTHIANS 5:21**
TRUE OR FALSE

280. IN CHRIST, WE ARE A NEW CREATION

(2 CORINTHIANS 5:14-21)

P Y M L D U D Z L G U C U Y J
A Y B Z W F G J L K M M K Y E
S O S B Y I R O M B D L O O S
S F V P P B C P D H S E L F O
E V N O I T A E R C W E N J R
D B S J Z G G N S N E W I F T
A S O I W Y R U Z U L B T A P
W V J H N P G D E I D B E H L
A S S E N S U O E T H G I R J
Y M J G B S G N I H T D L O C
S A D E L I C N O C E R J A V
T Z E E M Y N O F K S A K H E
A M B A S S A D O R S C K Z V
F S A U W B G F P C V W P Y O
A H W W T S I R H C R J Z N L

AMBASSADORS
CHRIST
DIED
FLESH
GOD

LOVE
NEW CREATION
NEW
OLD THINGS
PASSED AWAY

RECONCILED
RIGHTEOUSNESS
ROSE
SIN

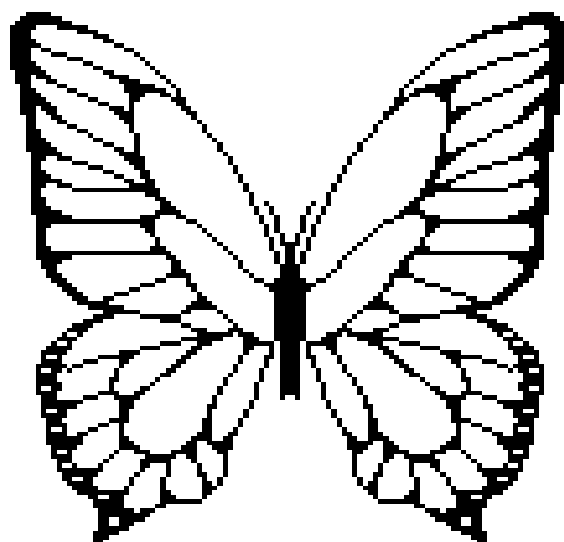

280. IN CHRIST, WE ARE A NEW CREATION (2 CORINTHIANS 5:14-21)

MEMORY VERSE:

"Therefore if anyone is in Christ, he is a new creation; old things have passed away; behold, all things have become new." 2 CORINTHIANS 5:17

"For the love of God constrains us, because we judge thus..."

TRUE OR FALSE:

1. "...That if One died for all, then all died." **2 CORINTHIANS 5:14**
TRUE OR FALSE
2. "And He died for all, that those who live should no longer live for themselves, but for Him who died for them and rose again." **2 CORINTHIANS 5:15**
TRUE OR FALSE

FILL IN THE BLANKS:

3. "If anyone is in Christ, he is a new _____; old things have passed away; behold, _____ things have become new." **2 CORINTHIANS 5:17**

TRUE OR FALSE:

4. "...God was in Christ reconciling the world to Himself..." **2 CORINTHIANS 5:19**
TRUE OR FALSE

FILL IN THE BLANKS:

5. "Therefore we are ambassadors for _____, as though God were pleading through us: we implore you on Christ's behalf, be _____ to God." **2 CORINTHIANS 5:20**

TRUE OR FALSE:

6. "For He made Him who knew no sin to be sin for us, that we might become the righteousness of God in Him." **2 CORINTHIANS 5:21**
TRUE OR FALSE

280. IN CHRIST, WE ARE A NEW CREATION (2 CORINTHIANS 5:14-21)

P Y F A N R D Z C I F V K A Z A M W I U
 A T W B S F W U L L E T P U P I B Y C D
 S E B R H M E S E S S A P S E R T U P I
 S Z Y B U E E S W P M O Z K E P U K L V
 E T L E S T H S N I A R T S N O C Y O E
 D S D W Y L B G C N H A S S U Q V H P M
 A I E G J S W E N S M J T Y V F E F D N
 W R I D N M S F A B Y Q V B F R Z Q Q B
 A H D E D O D E A C Y L G F I C N B J A
 Y C N L Y E L S N N M P W L U E N H J S
 V Q D I I Z S D Z S B V D K W I U M C P
 S V C C B A V Y T P U G K C S G U G B W
 L L V N D I N I S H P O R I H O I Q V E
 B S O O L I P F D C I E E Q I W B W V R
 M R R C O D Y B G B A N A T P J Q O D O
 I S S E U Z G L P T R Y G S H V L G I S
 O S K R P P N A I C Y Q O S K G B B M E
 B B L F W Z W O C B R D D S R H I W O J
 K B D Z C V N E V P E O G O E Y V R O H
 E Z F A P U Y Z U R B O S E N G B D F N

AMBASSADORS
 CHRIST
 CONSTRAINS
 DIED
 FLESH
 GOD

LOVE
 NEW
 NEW CREATION
 OLD THINGS
 PASSED AWAY

RECONCILED
 RIGHTEOUSNESS
 ROSE
 SIN
 TRESPASSES

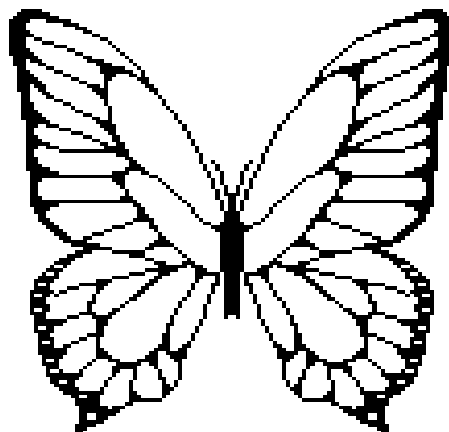

280. IN CHRIST, WE ARE A NEW CREATION

(2 CORINTHIANS 5:14-21)

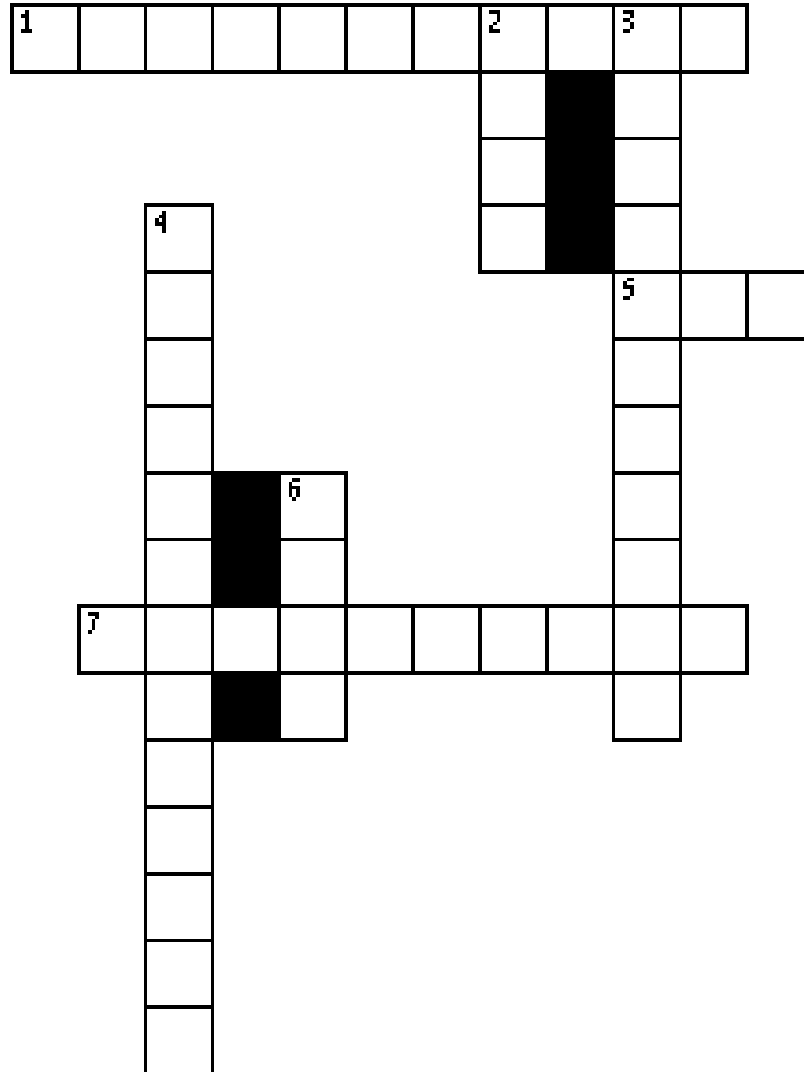

- 7 ACROSS "For the love of God _____ us, because we judge thus..." **2 CORINTHIANS 5:14**
- 2 DOWN "...That if One _____ for all, then all died." **2 CORINTHIANS 5:14**
- 6 DOWN "And He died for all, that those who live should no longer live for themselves, but for Him who died for them and _____ again." **2 CORINTHIANS 5:15**
- 5 ACROSS "If anyone is in Christ, he is a new creation; old things have passed away; behold, all things have become _____." **2 CORINTHIANS 5:17**
- 3 DOWN "...God was in Christ _____ the world to Himself..." **2 CORINTHIANS 5:19**
- 1 ACROSS "Therefore we are _____ for Christ, as though God were pleading through us: we implore you on Christ's behalf, be reconciled to God." **2 CORINTHIANS 5:20**
- 4 DOWN "For He made Him who knew no sin to be sin for us, that we might become the _____ of God in Him." **2 CORINTHIANS 5:21**

Bible Story 281

**THE
CHURCHES
OF MACEDONIA
ARE GIVING**

2 CORINTHIANS 8:1-7

281. THE CHURCHES OF MACEDONIA ARE GIVING (2 CORINTHIANS 8:1-7)

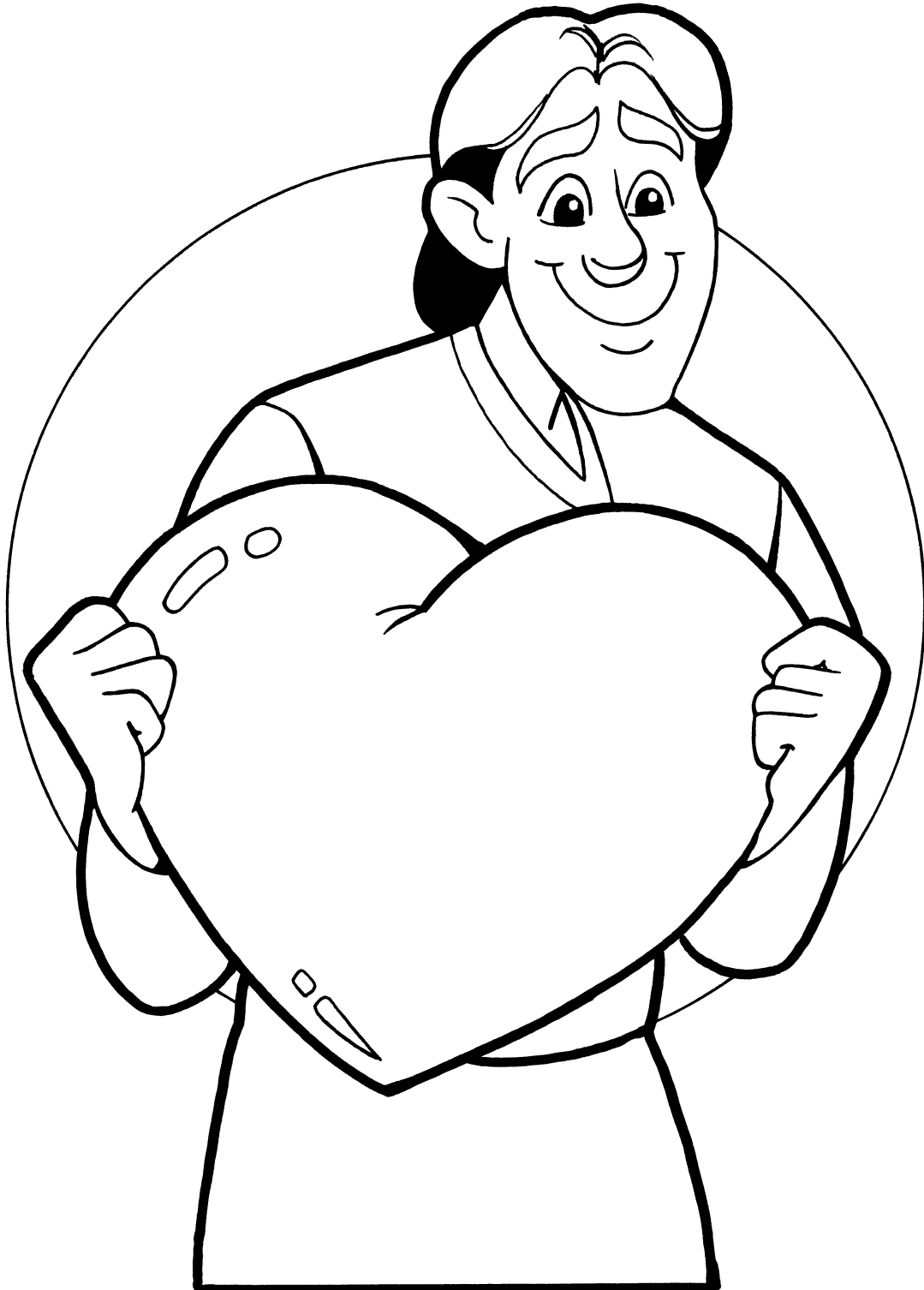

"Moreover, brethren, we do you to wit of the grace of God bestowed on the churches of Macedonia;"

2 CORINTHIANS 8:1

"I speak not by commandment, but by occasion of the forwardness of others,
and to prove the sincerity of your love." **2 CORINTHIANS 8:8**

281. THE CHURCHES OF MACEDONIA ARE GIVING (2 CORINTHIANS 8:1-7)

MEMORY VERSE:

"But as you abound in everything- in faith, in speech, in knowledge, in all diligence, and in your love for us- see that you abound in this grace also." 2 CORINTHIANS 8:7

"Moreover, brethren, we make known to you the grace of God bestowed on the churches of Macedonia..."

CIRCLE THE CORRECT WORDS:

1. "For I bear witness that according to their ability, yes and beyond their ability, they were freely **(WILLING, FORCED)**..." 2 CORINTHIANS 8:3
2. "...imploing us with much urgency that we would **(RECEIVE, REJECT)** the gift and fellowship of the ministering to the saints." 2 CORINTHIANS 8:4

TRUE OR FALSE:

3. "And this they did, not as we had hoped, but first gave themselves to the Lord, and then to us by the will of God." 2 CORINTHIANS 8:5
TRUE OR FALSE

CIRCLE THE CORRECT WORDS:

4. "So we urged **(TITUS, PETER)**, that as he had begun, so he would also complete this grace in you as well." 2 CORINTHIANS 8:6
5. "But as you abound in everything- in faith, in speech, in knowledge, in all diligence, and in your love for us- see that you abound in this **(PLACE, GRACE)** also." 2 CORINTHIANS 8:7

281. THE CHURCHES OF MACEDONIA ARE GIVING

(2 CORINTHIANS 8:1-7)

C P D Z F I H D J N H N I F T
 T U W D E S M A C E D O N I A
 C H R F A G A Q T A T K E O O
 J O C I E U D G R A C E P J M
 L T N E V L U E A Y T B I W J
 W T Q Z E A L C L Y O J Y S K
 S N T T I P Y O A W R C B S G
 Y D B F R F S T W S O D B I H
 J C I N I I U U R S E N P A E
 T R H K O G A J U E H H K G V
 N A T U T F T L E G V I C W O
 A Z A O R I T K N Q O O P I L
 S E L B N C T S Q U R D P A R
 F A I T H T H U B Q W W P F G
 L M B H H Q D M S T P K Y U D

CHURCH
 FAITH
 FELLOWSHIP
 GIFT
 GOD
 GRACE

JOY
 KNOWLEDGE
 LORD
 LOVE
 MACEDONIA
 POVERTY

RICHES
 SAINTS
 SPEECH
 TITUS
 TRIAL

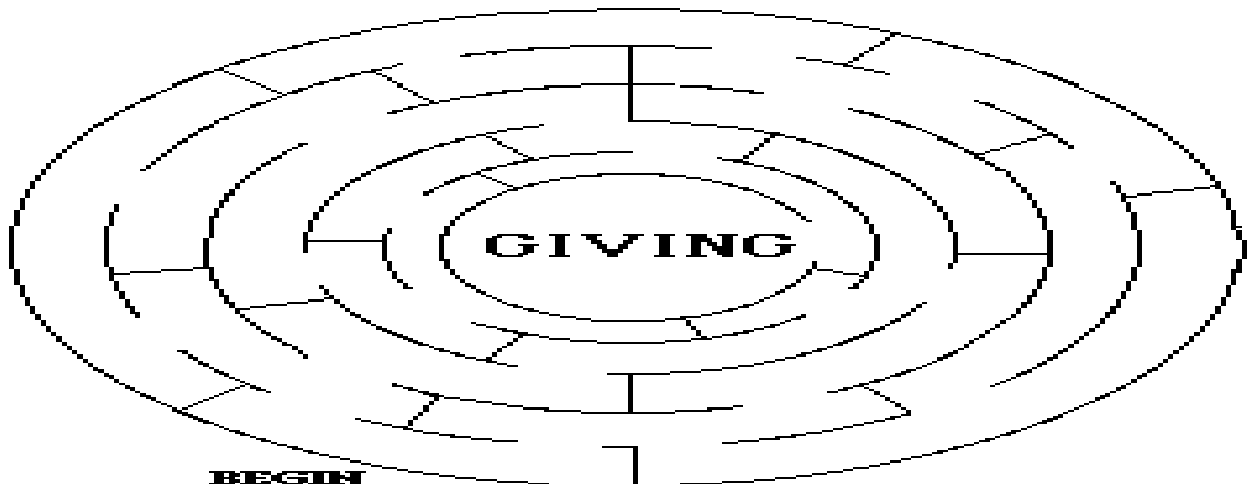

281. THE CHURCHES OF MACEDONIA ARE GIVING (2 CORINTHIANS 8:1-7)

MEMORY VERSE:

"But as you abound in everything- in faith, in speech, in knowledge, in all diligence, and in your love for us- see that you abound in this grace also." 2 CORINTHIANS 8:7

"Moreover, brethren, we make known to you the grace of God bestowed on the churches of Macedonia..."

FILL IN THE BLANKS:

1. "For I bear witness that according to their ability, yes and beyond their ability, they were freely _____..." **2 CORINTHIANS 8:3**
2. "...imploping us with much urgency that we would _____ the gift and fellowship of the ministering to the saints." **2 CORINTHIANS 8:4**

TRUE OR FALSE:

3. "And this they did, not as we had hoped, but first gave themselves to the Lord, and then to us by the will of God." **2 CORINTHIANS 8:5**
TRUE OR FALSE

FILL IN THE BLANKS:

4. "So we urged _____, that as he had begun, so he would also complete this grace in you as well." **2 CORINTHIANS 8:6**
5. "But as you abound in everything- in faith, in speech, in knowledge, in all diligence, and in your love for us- see that you abound in this _____ also." **2 CORINTHIANS 8:7**

281. THE CHURCHES OF MACEDONIA ARE GIVING (2 CORINTHIANS 8:1-7)

V B F H P V M V S E T D A S M K K Z B L Y B V R M
 R O N S Q P N V V O B F G Z G Z S T L B B B S A U
 F N F L L Z Q D M R U H H N Q L N T I F C R B F Z
 W C O S A S Q K O I L L G W O X U X A H M B K W D
 P R T E U M H B N Y Y D N I T I W S I V U Q Y V C
 D B H Q L T V S G S L I W O H V Y T R E V O P B A
 W B D M L B I G I P H Y B V K V S M R E A K F Q B
 V I T B M A Z T N Y I A O M W T C H O L K L D J F
 G F N B S K U H C I I H W J W H T V N C I E Q C L
 J A Y C O I D P N N V P S G B L C L T J L S N A I
 T W B B A Y F P O D B I B W L C O E V I O Z N S H
 F B P B L T H D E Y E M G D O V P Y E T Z R F B V
 G B B Y K F E R B G K W V O E L M B B P I L Y W M
 J Y U U N C G B D B K L F T R M L L K S S U V D E
 W K L W A Z U E P O B A B T Q G S E T D J C Y I Y
 J Y N M M B L N U J I G F B C B D N F B O R B A Y
 H T Z D G W Q G U T D I H B R M I M C I Z G F J S
 G P H O O C J B H C G S C V H A E C N E G I L I D
 B S R N C S V L R V O Z O N S P Q E E U T K P T Q
 A J K K G H Q L J G F R Y V N E H J U K T G N L K
 B V A L T L U N Z W B O K M G I E L Z B I W I N Y
 H D A J A S D R F H Q J E R N P N D B B J T D J J
 P T J Q E I D B C H R L A U V L P Z E F I D L O P
 T T Y B L N R Z J H K C O O G E T P Q A J C G I A
 Q Q G Z S P D T F B E L J B R P L E A S E H C I R

CHURCH
 DILIGENCE
 FAITH
 FELLOWSHIP
 GIFT
 GIVING
 GOD

GRACE
 JOY
 KNOWLEDGE
 LORD
 LOVE
 MACEDONIA

POVERTY
 RICHES
 SAINTS
 SPEECH
 TITUS
 TRIAL

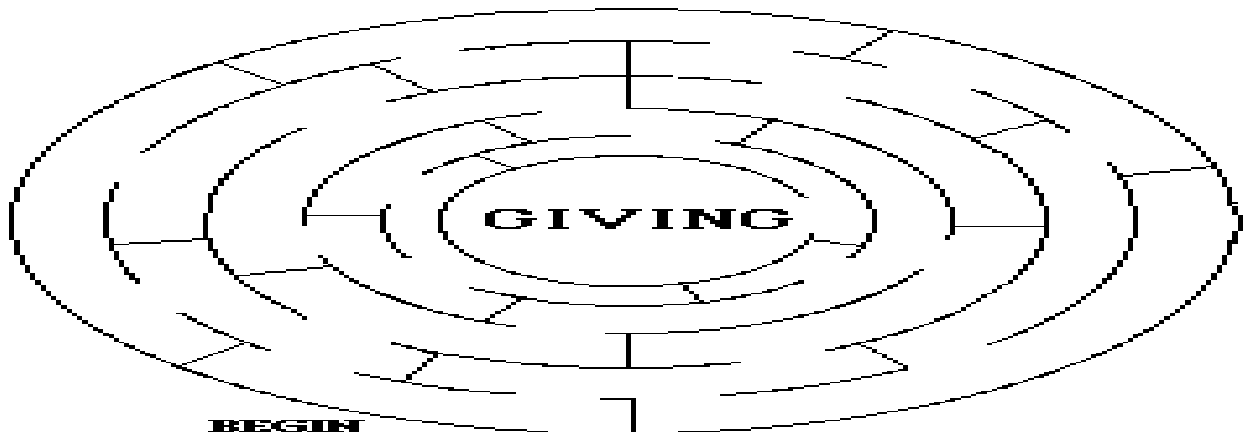

281. THE CHURCHES OF MACEDONIA ARE GIVING (2 CORINTHIANS 8:1-7)

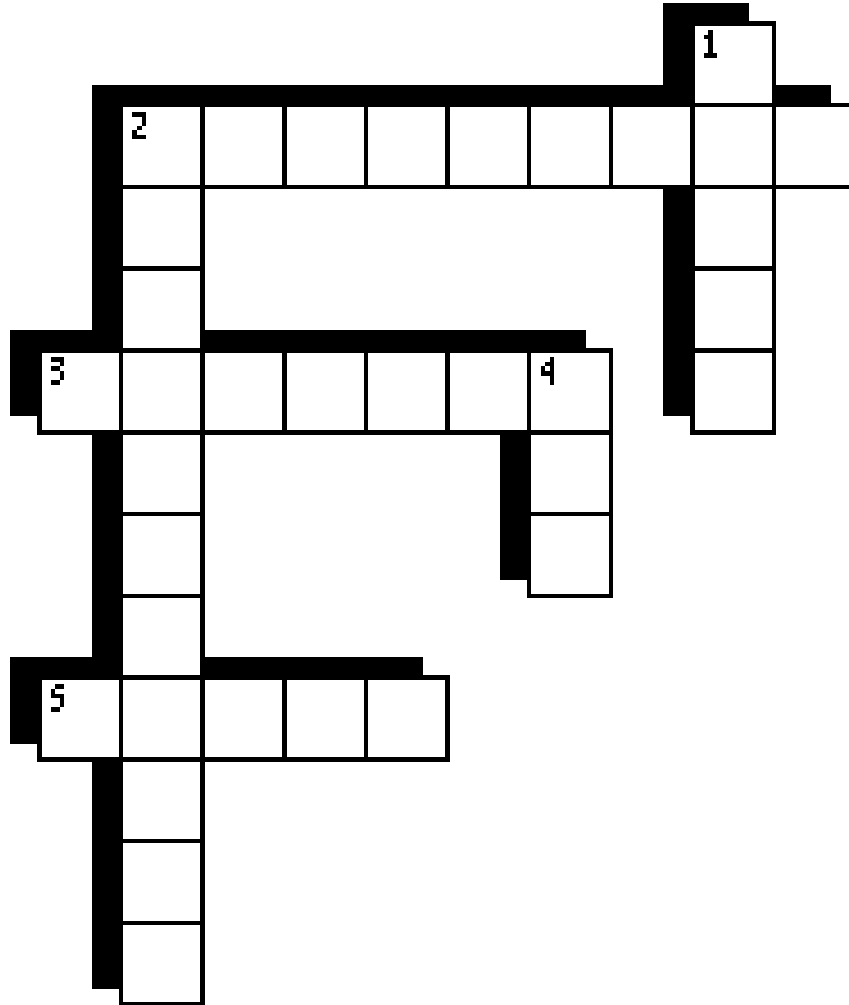

- 2 ACROSS "Moreover, brethren, we make known to you the grace of God bestowed on the churches of _____."
2 CORINTHIANS 8:1
- 3 ACROSS "For I bear witness that according to their ability, yes and beyond their ability, they were freely _____." **2 CORINTHIANS 8:3**
- 2 DOWN "...imploping us with much urgency that we would receive the gift and fellowship of the _____ to the saints." **2 CORINTHIANS 8:4**
- 4 DOWN "And this they did, not as we had hoped, but first gave themselves to the Lord, and then to us by the will of _____." **2 CORINTHIANS 8:5**
- 1 DOWN "So we urged _____, that as he had begun, so he would also complete this grace in you as well."
2 CORINTHIANS 8:6
- 5 ACROSS "But as you abound in everything- in faith, in speech, in knowledge, in all diligence, and in your love for us- see that you abound in this _____ also." **2 CORINTHIANS 8:7**

Bible Story 282

**THE
FRUIT OF THE SPIRIT**

GALATIANS 5:22-26

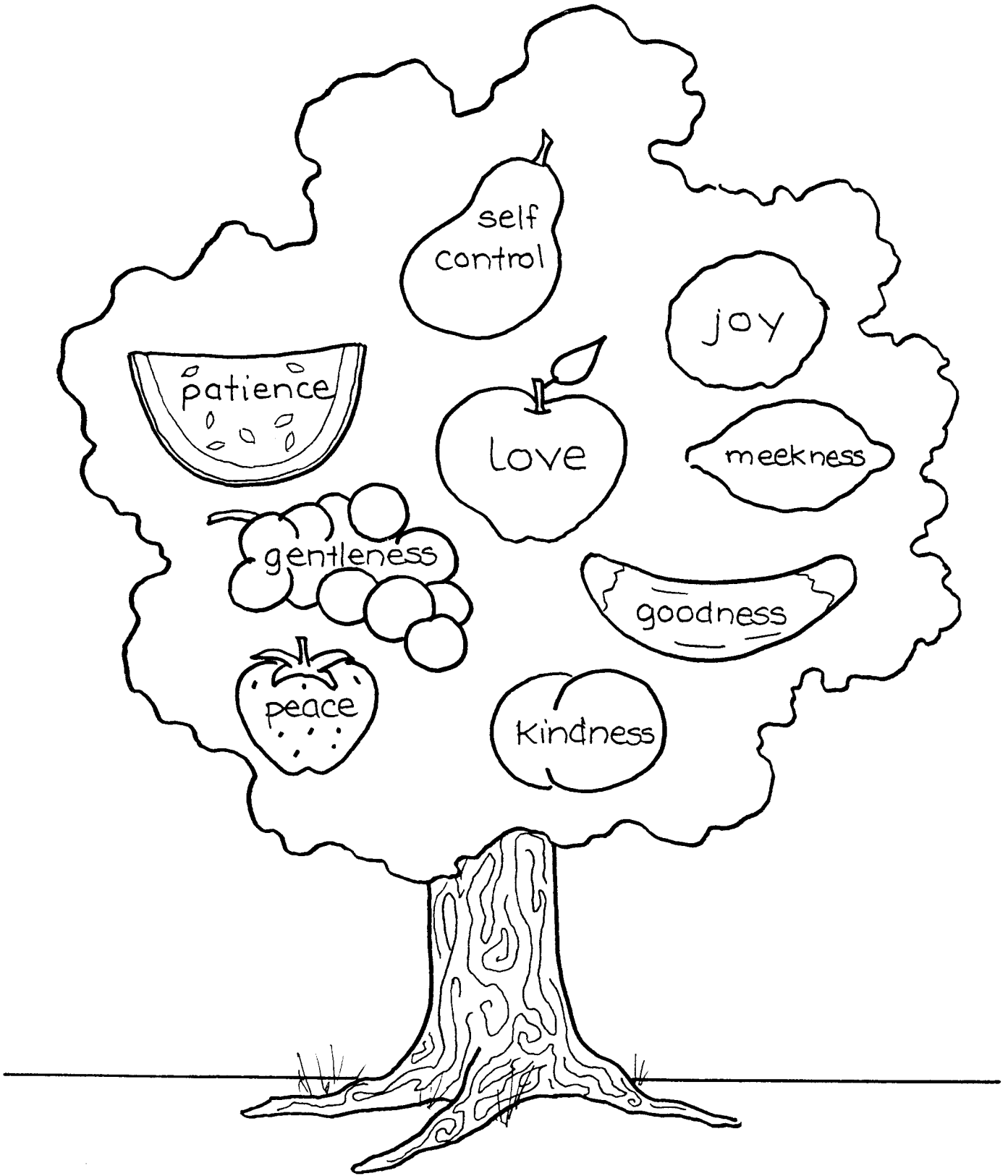

The fruit of the Spirit.
GALATIANS 5:22-26

282. FRUIT OF THE SPIRIT (GALATIANS 5:22-26)

MEMORY VERSE:

"If we live in the Spirit, let us also walk in the Spirit." GALATIANS 5:25

CIRCLE ALL THE CORRECT WORDS:

1. "But the fruit of the Spirit is..." GALATIANS 5:22-23

LOVE

ANGER

JOY

MEANNESS

PEACE

LONGSUFFERING

KINDNESS

GOODNESS

FAITHFULNESS

SELFISHNESS

GENTLENESS

SELF-CONTROL

TRUE OR FALSE

2. "...Against such there is no law." GALATIANS 5:23
TRUE OR FALSE

CIRCLE THE CORRECT WORD:

3. "And those who are Christ's have (**CRUCIFIED, FED**) the flesh with its passions and desires."
GALATIANS 5:24

TRUE OR FALSE

4. "If we live in the Spirit, let us also walk in the Spirit." GALATIANS 5:25
TRUE OR FALSE



282. THE FRUIT OF THE SPIRIT

(GALATIANS 5:22-26)

G P R K Y Z J J V D O U L C D
 E G C O Y Y C H M S E H W S D
 N K M I O N V Q F J W P J C B
 T B L T J J D E I F I C U R C
 L B L O R T N O C F L E S H B
 E K B E F T T O S F R U I T Q
 N C B J O Y W A W H E E U U K
 E B A J A P H T I R I P S E L
 S G N I R E F F U S G N O L L
 S M C K H S S E N D N I K O W
 M D S S E N D O O G B V V C K
 S L W K A L P W U Q K E O N I
 F A I T H F U L N E S S E Q J
 Z S J P H E C A E P S A P L S
 F V U Z S T S I R H C R T K U

CHRIST'S
 CRUCIFIED
 FAITHFULNESS
 FRUIT
 GENTLENESS

GOODNESS
 JOY
 KINDNESS
 LONGSUFFERING

LOVE
 PEACE
 SELF CONTROL
 SPIRIT

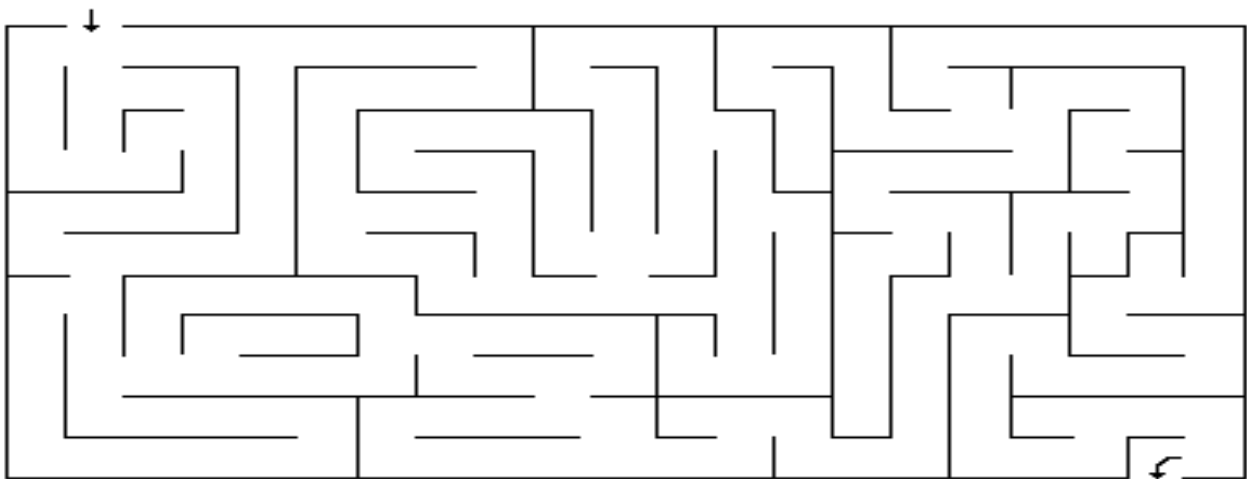

FRUIT OF THE SPIRIT

282. FRUIT OF THE SPIRIT (GALATIANS 5:22-26)

MEMORY VERSE:

"If we live in the Spirit, let us also walk in the Spirit." GALATIANS 5:25

CIRCLE ALL THE CORRECT WORDS:

1. "But the fruit of the Spirit is..." GALATIANS 5:22-23

LOVE

ANGER

JOY

MEANNESS

PEACE

LONGSUFFERING

KINDNESS

GOODNESS

FAITHFULNESS

SELFISHNESS

GENTLENESS

SELF-CONTROL

TRUE OR FALSE

2. "...Against such there is no law." GALATIANS 5:23
TRUE OR FALSE

FILL IN THE BLANKS:

3. "And those who are Christ's have _____ the _____ with its passions and desires." GALATIANS 5:24

4. "If we _____ in the Spirit, let us also _____ in the Spirit." GALATIANS 5:25



282. THE FRUIT OF THE SPIRIT

(GALATIANS 5:22-26)

C R S U Z B H K I O Z G S A H J E S J J V V G B D
 U S T S I R H C O F B Y Z C A H B C S O S Z E O C
 Q J J W I I A Q T V P P F W H K K H U U M K I U M
 D S F J V A W J A B J Y P J S D I U E G C F K V P
 C T F N V M B B N S H B G U P Q E N A F Z K B Z O
 N A O S B B P B R V G D K K I O S I D K L S P A E
 W G P Z Q T E R P M E R B T R A U E F N U M P U A
 T Z O S S E N E L T N E G O I W H C V I E O U E Y
 I S E O Y Y S B I A U C U I T U P N D D C S Z F U
 W D O K D L G Y Q Z W G K T Z V R Q Q B T U S P H
 P J O B E N O K D S D R C E Y M E F E K M A R T A
 L Q C Z L J E E J H W G L J N F V L N K O T V C E
 O I F F N I D S Q M Y N U O J S A K R A E M F O C
 V K K H V O E F S B P G M K N W R D Y T M Z R N N
 E T S S E N L U F H T I A F T G L D Y W B J K I A
 P D B N Q V P J R S Z Z D K P U S O D L N S K J I
 W Y Y G T Q Z T I V W J L P L D W U J A O M Y J Z
 Q H N B A Z C E L O B P S Z J S J K F P B B R Y S
 T U M G Q U C J S J M N V Y C J U E I F U P G T N
 A Q H R F A Q Z T J W U R Y V H C Q P P E C I H C
 S E L F C O N T R O L O C O T A O K T A L R K G Z
 U S L Q H N I Z F E U F M J E Q E L V B P D I F B
 U S D I P M W K A A F L L P W O P W R V M T U N R
 H I R P J G Z C Y W I L B F H E T K F Q C B A Y G
 E L E H T F K T Y L B M B A P W C I E D C B V Q P

CHRISTS
CRUCIFIED
FAITHFULNESS
FRUIT
GENTLENESS

GOODNESS
JOY
KINDNESS
LONGSUFFERING

LOVE
PEACE
SELF CONTROL
SPIRIT

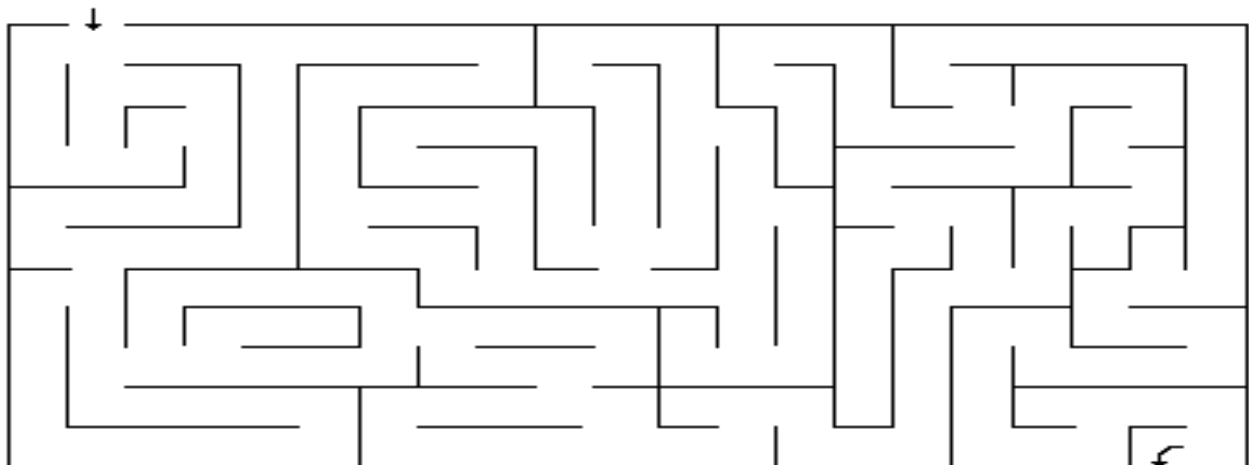

FRUIT OF THE SPIRIT

282. FRUIT OF THE SPIRIT

(GALATIANS 5:22-26)

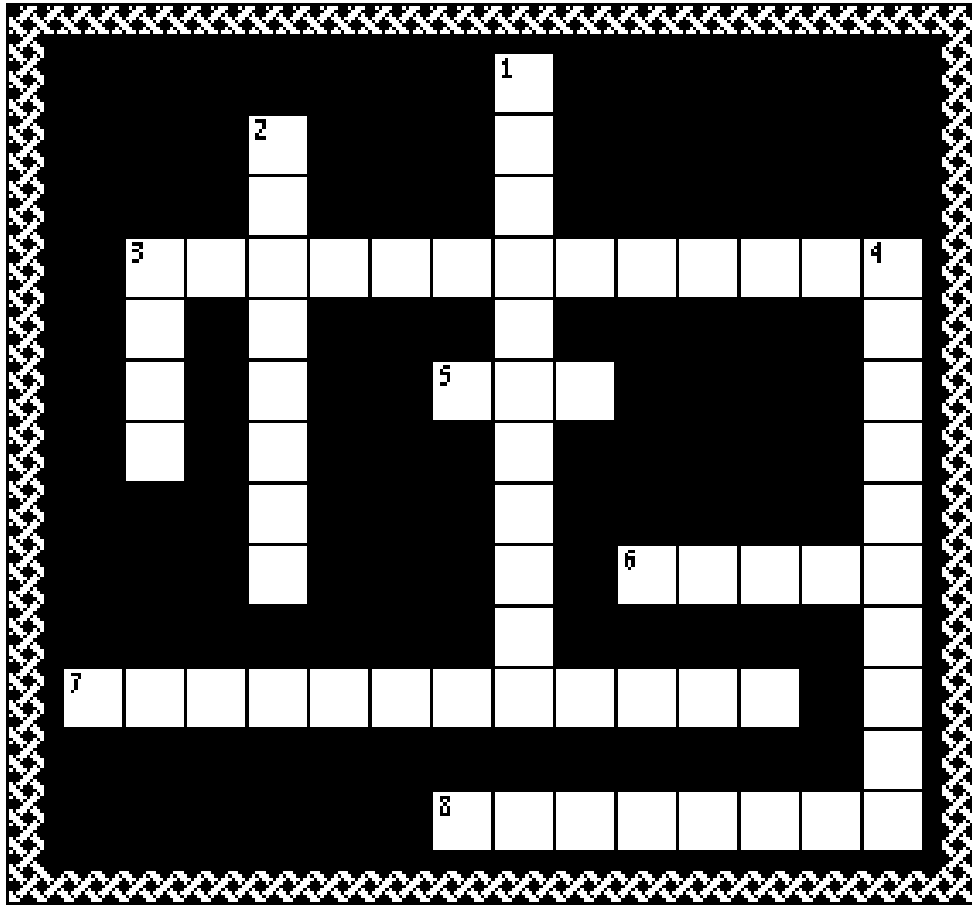

"But the fruit of the Spirit is..."

- 3 DOWN _ _ _ _ GALATIANS 5:22
- 5 ACROSS _ _ _ GALATIANS 5:22
- 6 ACROSS _ _ _ _ GALATIANS 5:22
- 3 ACROSS _ _ _ _ _ _ _ _ GALATIANS 5:22
- 2 DOWN _ _ _ _ _ _ _ GALATIANS 5:22
- 8 ACROSS _ _ _ _ _ _ GALATIANS 5:22
- 7 ACROSS _ _ _ _ _ _ _ _ GALATIANS 5:22
- 4 DOWN _ _ _ _ _ _ _ GALATIANS 5:23
- 1 DOWN _ _ _ _ _ _ _ GALATIANS 5:23

"If we live in the Spirit, let us also walk in the Spirit." GALATIANS 5:25

Bible Story 283

SOWING AND REAPING

GALATIANS 6:6-10

283. SOWING AND REAPING
(GALATIANS 6:6-10)



" Be not deceived; God is not mocked: for whatsoever a man soweth, that shall he also reap."
GALATIANS 6:7

283. SOWING AND REAPING

(GALATIANS 6:6-10)

MEMORY VERSE:

"Therefore, as we have opportunity, let us do good to all, especially to those who are of the household of faith." GALATIANS 6:10

TRUE OR FALSE:

1. "Let him who is taught the word share in all good things with him who teaches."
GALATIANS 6:6
TRUE OR FALSE
2. "Do not be deceived, God is not mocked..." **GALATIANS 6:7**
TRUE OR FALSE
3. "...for whatever a man sows, that he will also reap." **GALATIANS 6:7**
TRUE OR FALSE

CIRCLE THE CORRECT WORDS:

4. "For he who sows to his flesh will of the flesh reap (**REWARDS, CORRUPTION**)..."
GALATIANS 6:8
5. "...but he who sows to the Spirit will of the Spirit reap everlasting (**LIFE, TROUBLE**)."
GALATIANS 6:8

TRUE OR FALSE:

6. "And let us not grow weary while doing good, for in due season we shall reap if we do not lose heart." **GALATIANS 6:9**
TRUE OR FALSE
7. "Therefore, as we have opportunity, let us do good to all, especially to those who are of the household of faith." **GALATIANS 6:10**
TRUE OR FALSE

283. SOWING AND REAPING

(GALATIANS 6:6-10)

G	F	G	M	G	B	W	H	C	Q	W	T	E	N	A
M	K	S	B	T	S	T	A	U	G	H	T	M	K	F
B	E	N	D	H	R	E	Q	A	V	Y	N	D	O	F
P	T	F	A	E	O	A	I	L	P	D	R	O	W	T
M	G	R	I	D	C	L	E	O	B	H	S	E	L	F
W	E	B	B	L	S	E	L	H	Q	J	T	W	B	Q
N	E	S	O	W	S	S	I	Z	J	T	I	Q	H	H
G	Y	K	O	P	L	V	P	V	I	N	R	B	F	A
K	F	K	H	M	K	D	H	A	E	A	I	I	V	U
B	G	A	S	K	O	D	T	M	E	D	P	T	I	U
Y	M	O	I	S	W	C	Y	F	C	R	S	A	O	T
K	Q	J	S	T	V	Z	K	M	T	S	D	L	N	T
P	H	Q	R	P	H	Z	O	E	C	L	R	B	H	D
U	V	S	V	P	J	O	A	Q	D	P	A	Z	I	D
Y	V	P	N	R	B	W	V	S	J	U	Z	Z	U	Q

DECEIVED

FAITH

FLESH

HEART

LIFE

MOCKED

REAPS

SHARE

SOWS

SPIRIT

TAUGHT

WORD

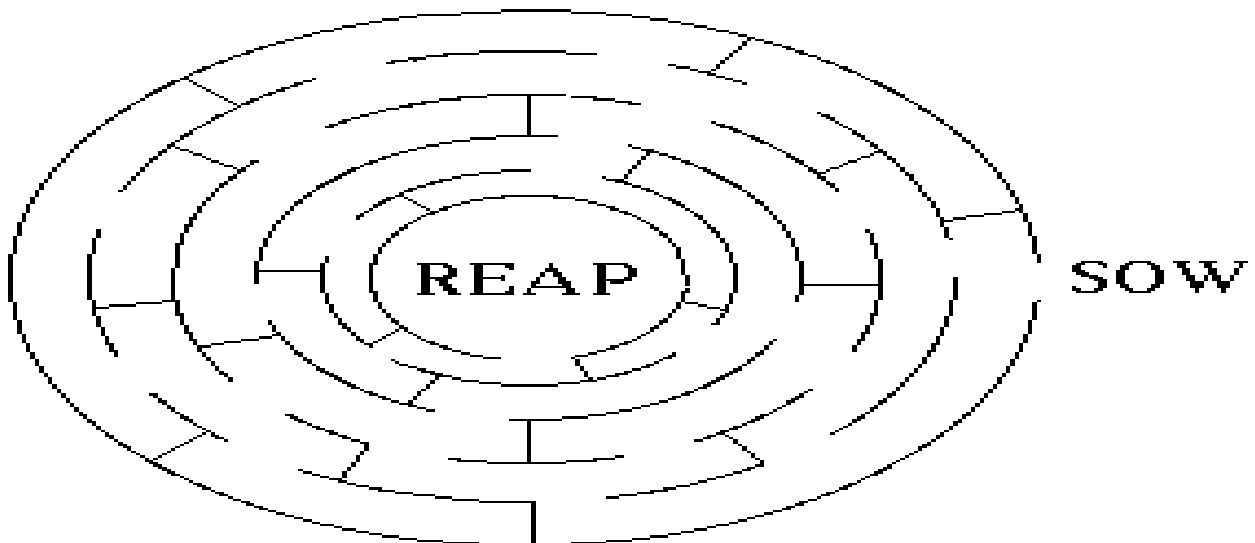

283. SOWING AND REAPING (GALATIANS 6:6-10)

MEMORY VERSE:

"Therefore, as we have opportunity, let us do good to all, especially to those who are of the household of faith." GALATIANS 6:10

TRUE OR FALSE:

1. "Let him who is taught the word share in all good things with him who teaches."
GALATIANS 6:6
TRUE OR FALSE
2. "Do not be deceived, God is not mocked..." **GALATIANS 6:7**
TRUE OR FALSE
3. "...for whatever a man sows, that he will also reap." **GALATIANS 6:7**
TRUE OR FALSE

FILL IN THE BLANKS:

4. "For he who sows to his flesh will of the flesh reap _____..." **GALATIANS 6:8**
5. "...but he who sows to the Spirit will of the Spirit reap everlasting _____." **GALATIANS 6:8**

TRUE OR FALSE:

6. "And let us not grow weary while doing good, for in due season we shall reap if we do not lose heart." **GALATIANS 6:9**
TRUE OR FALSE
7. "Therefore, as we have opportunity, let us do good to all, especially to those who are of the household of faith." **GALATIANS 6:10**
TRUE OR FALSE

283. SOWING AND REAPING

(GALATIANS 6:6-10)

B G N H C I U U F Z W E M G K U W S V L K Y M P Y M G Y N I
 M E G Q T T U Q O H W H U K W Q K G K A U A N L M R I A Z U
 K Y D I C A T T J K Z T B G I T M J U I M Q Q J T B F E F Q
 U G P L S L T H W D R L S D E C E I V E D A R D F G L M N H
 Y M K W J B E T S E E U E P U P S P O L B O U D H B B B B C
 Y Q O D W Z D V A K O K J S M L E Z Z R Y Y M R D I K Z A C
 R S S H O Z D P E R A W C O F J A F B U R E E M R V M U D N
 F H P T Y G S T S R K Q M O O B S B A U T A S J D R O W P U
 H V P Y J N Q R I E L N G T M J O B M C T T H G U A T I U K
 E V R O T K C R A N U A O W E H N K Z Q C E Z L S S I J K S
 L G X A N O U W G C N I S I P T L M B N M Q P P M M U L I U
 M S O V A B J P W V U S V T K J U Z T R P U J N C K B M B N
 G N S C S H K N A C D V Y H I Y G B P U M T H O U I W P R E
 M B L A L F S K F C L U S R J N C I Z K L V D I R R V X Q S
 B K K L P V M B U H U U P J A R G Z F B C S C T S K K E I X
 P K W O U I J C T R F A T D F E V L V I S E U P J Q G C J T
 M O F Z T O T D O E L D W U Y D W F I F G T U U L Y P H L I
 W J V L N N A W O P Y D B O T C U Z F F E K S R P C H M J L
 N Q J M E H A K M M P W H L W G B B H W E N Y R B Z K B V E
 G S B F D S U I J Q H O J O U S N D N L Y B J O N A H I R I
 K P W M R I H E K N B T R H T I A F E T U Y G C S K C V R A
 B M E Q A U E P G Y O L Y T G Q H K E R W Z A O L R O M K K
 Y B L S Z A N I H M I A K U U U B B M A I A K L P V V T J Q
 K B V Q E F Q Y G A R O P I H N A U J E A X R T H Z N Q S Y
 P O D V M F B B D S F A S I B M I Y Q H C U B P L Y J V F R
 U H D P D T N B E V Y P P B V J U T V J L E N N Q E L U Q X
 Y S Z B W Q A R V Y B A I R S Q V E Y B P D Y R U H D G V T
 F S Z Q Q H A P B K D D R W U L A E E B A K N A I Z R B B P
 K R O J B H Y P G W F Y I G B J E J V K I G M P C C Z D R K
 T V W I S A Q Y C L B S T T H T I A V J E C Q L C S B O B Z

CORRUPTION

DECEIVED

EVERLASTING LIFE

FAITH

FLESH

GOD

HEART

MOCKED

OPPORTUNITY

REAPS

SEASON

SHARE

SOWS

SPIRIT

TAUGHT

WEARY

WORD

283. SOWING AND REAPING

(GALATIANS 6:6-10)

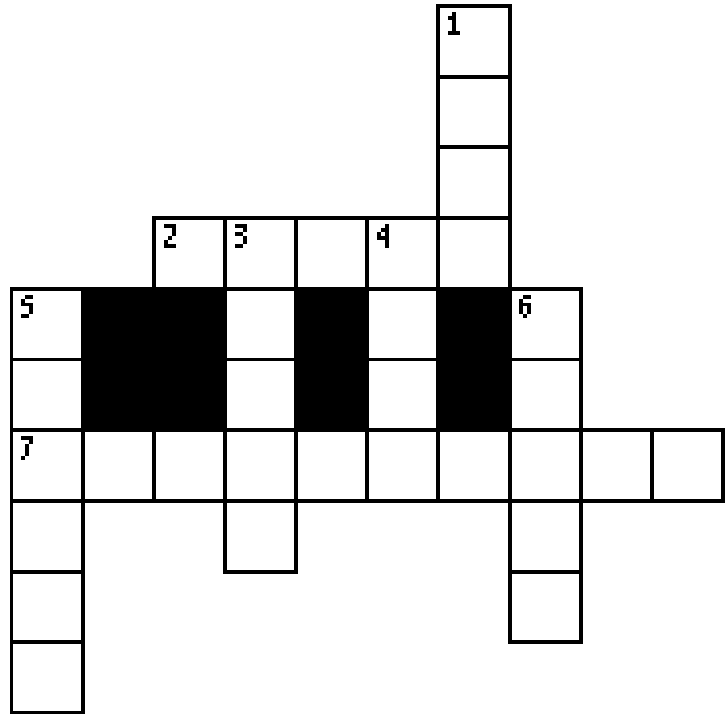
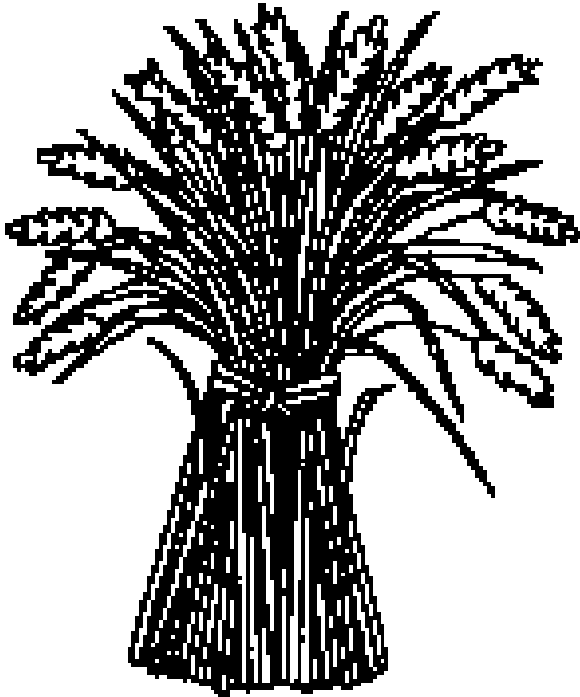

- 2 ACROSS "Let him who is taught the word _____ in all good things with him who teaches." **GALATIANS 6:6**
- 5 DOWN "Do not be deceived, God is not _____." **GALATIANS 6:7**
- 4 DOWN "...for whatever a man sows, that he will also _____." **GALATIANS 6:7**
- 7 ACROSS "For he who sows to his flesh will of the flesh reap _____." **GALATIANS 6:8**
- 1 DOWN "...but he who sows to the Spirit will of the Spirit reap everlasting _____." **GALATIANS 6:8**
- 3 DOWN "And let us not grow weary while doing good, for in due season we shall reap if we do not lose _____." **GALATIANS 6:9**
- 6 DOWN "Therefore, as we have opportunity, let us do good to all, especially to those who are of the household of _____." **GALATIANS 6:10**

Bible Story 284

**BY GRACE
THROUGH FAITH**

EPHESIANS 2:1-10

284. BY GRACE THROUGH FAITH
(EPHESIANS 2:1-10)



"For by grace you have been saved through faith, and that not of yourselves; it is the gift of God, not of works, lest anyone should boast."

EPHESIANS 2:8-9

284. BY GRACE THROUGH FAITH

(EPHESIANS 2:1-10)

MEMORY VERSE:

"For by grace you have been saved through faith, and that not of yourselves; it is the gift of God, not of works, lest anyone should boast." EPHESIANS 2:8-9

TRUE OR FALSE:

1. "And you He made alive, who were dead in trespasses and sins." EPHESIANS 2:1
TRUE OR FALSE

CIRCLE THE CORRECT WORDS:

2. "But God, who is rich in mercy, because of His great love with which He loved us, even when we were dead in trespasses, made us alive together with Christ (by **(GRACE, WORKS)** you have been saved)." EPHESIANS 2:4-5
3. "For by grace you have been saved through (FAITH, WORKS), and that not of yourselves..." EPHESIANS 2:8

TRUE OR FALSE:

4. "...it is the gift of God, not of works, lest anyone should boast." EPHESIANS 2:8-9
TRUE OR FALSE
5. "For we are His workmanship..." EPHESIANS 2:10
TRUE OR FALSE

CIRCLE THE CORRECT WORD:

6. "...created in Christ Jesus for good works, which (**(GOD, MEN)**) prepared beforehand that we should walk in them." EPHESIANS 2:10

284. BY GRACE THROUGH FAITH

(EPHESIANS 2:1-10)

E I N D D T V O G S C L M H P
H K O O W J H W I E J L E Q C
T W J J T G S E F V Y V Z B Q
S B R P Y A T C T L C C B K I
A G R A C E O U R E T B O L Y
O N O T F Z L C L S G B E G R
B K S D H T S J P R U S O Q O
D C Z H Z R T T J U T D B I I
I H G Q O U O H Z O B B S J T
L P E A W U R U Z Y B F K G E
Q U C F G J L H G Q T H R F H
D E V A S Q B D U H G O O A I
S M J A N Y O N E N B C W I B
Z J B A Z K Z L P B G G V T O
G B P H T K U Z F Q A S D H E

ANYONE
SHOULD
LEST
FAITH
WORKS
SAVED
GOD

GRACE
BOAST
THROUGH
NOT
GIFT
YOURSELVES

FAITH

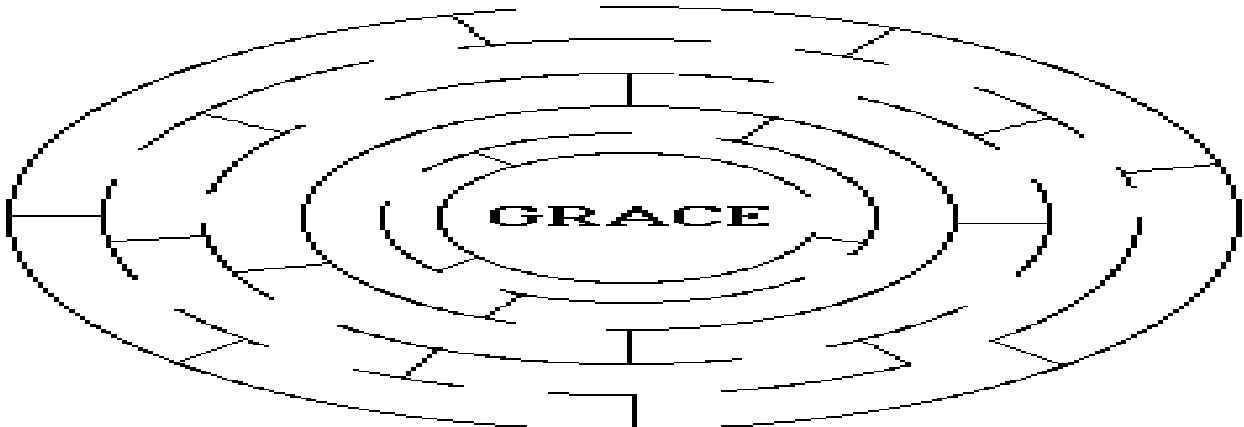

284. BY GRACE THROUGH FAITH

(EPHESIANS 2:1-10)

MEMORY VERSE:

"For by grace you have been saved through faith, and that not of yourselves; it is the gift of God, not of works, lest anyone should boast." EPHESIANS 2:8-9

TRUE OR FALSE:

1. "And you He made alive, who were dead in trespasses and sins." EPHESIANS 2:1
TRUE OR FALSE

FILL IN THE BLANKS:

2. "But God, who is rich in mercy, because of His great love with which He loved us, even when we were dead in trespasses, made us alive together with Christ (by _____ you have been saved)." EPHESIANS 2:4-5
3. "For by grace you have been saved through _____, and that not of yourselves..." EPHESIANS 2:8

TRUE OR FALSE:

4. "...it is the gift of God, not of works, lest anyone should boast." EPHESIANS 2:8-9
TRUE OR FALSE
5. "For we are His workmanship..." EPHESIANS 2:10
TRUE OR FALSE

FILL IN THE BLANK:

6. "...created in Christ Jesus for good works, which _____ prepared beforehand that we should walk in them." EPHESIANS 2:10

284. BY GRACE THROUGH FAITH (EPHESIANS 2:1-10)

U P N D R Q Q Z A V G G R Z U C R A K Z I S I V K V O S L K
D M W Y E Y Z K N B E N C Y D H Y B F V J N P Y I W O R K S
W N T H U E U K H S U G M N S U Y V K F J C G Y J I P L R G
R R I U W L A Q T V W Z L J J E D Q S R Y Z C R E F F C R B
K B W Q J N N J I M D J B T H C J D M E T B J T F R D Y E Q
H D P S N V M B A A W P B P Q N I V O K C R N E S N H D V L
D C P S S Q G B F Z Y N A L O Q P S A K H A H N O T D T U J
P U W I Z T F R R S P U C J E L T M T Y G P R U A Y F L V V
T G Q L D L U O H S Z O W C W K V C M R F J E G G M W V P U
B D T S K A H B P H W F J V E D R Z Z G Y P D S Q Z Y P I B
H T A J B Q A K I M B L U T B D F L J I Q Q B S F U S T R E
R A U F Z F W E Q B M L K W K O E U S B D B Y F H I B J F A
U S U F F H B F D S W M O H S K J T M U C Q B J W K T I V F
I T H O H P P J J V U S I P U Y O M B A M F B S U N E P Q I
W O E P N J E T Q O F Z T J H Q O O P V P G J G I M F K B M
V T R E G T S E R J I F E H P K U U C B O A M R K C Y D I I
B W S N A I S E H P E P J Q E L G E R O E M V A E D R A P O
M F J O B B G J I J B G K O V W F M D S A M W S Y N N Y O Q
C A S O G I D Z L E G K K A A K K B T U E A Z F B Y L S R H
B M T C R A E Z S G Y B P W R I D N B V Y L F N T J M G A U
H F A F Q M P K I A P U Z V L J B O B Z U O V T I D A M V N
P H Z K I B Z F T W Y K Y M W S K B G A H K I E O V B B K H
D K S B P T T C F L B C Y F J U K U E U A C Z Q S C T T R P
E N D Y H Y C T A Z D U O S U E A L D O G Y T C W U O L W U
B T H R O U G H Y B A S J B O A T P I E E U M D A A N A Y Y
C C J N Z L C I Y N A M F O E V W M K F C D G Y E U K B B N
P U Q M I I Q O Y V R D A A P D L C B P N Y G R P T V H G M
O Q I H V O I O E P C L H S T Q A C P T A G R Q Q E E P P H
G D K L V V N D O J G S A T C E P V P O I T H T T K F U F B
U C T D B E W T F H R V H W S N P Z U N Z I U B F O G V Q Y

FIND THE UNDERLINED WORDS

"For by grace you have been saved through faith, and not of yourselves; it is the gift of God, not of works, lest anyone should boast." EPHESIANS 2:8-9

284. BY GRACE THROUGH FAITH

(EPHESIANS 2:1-10)

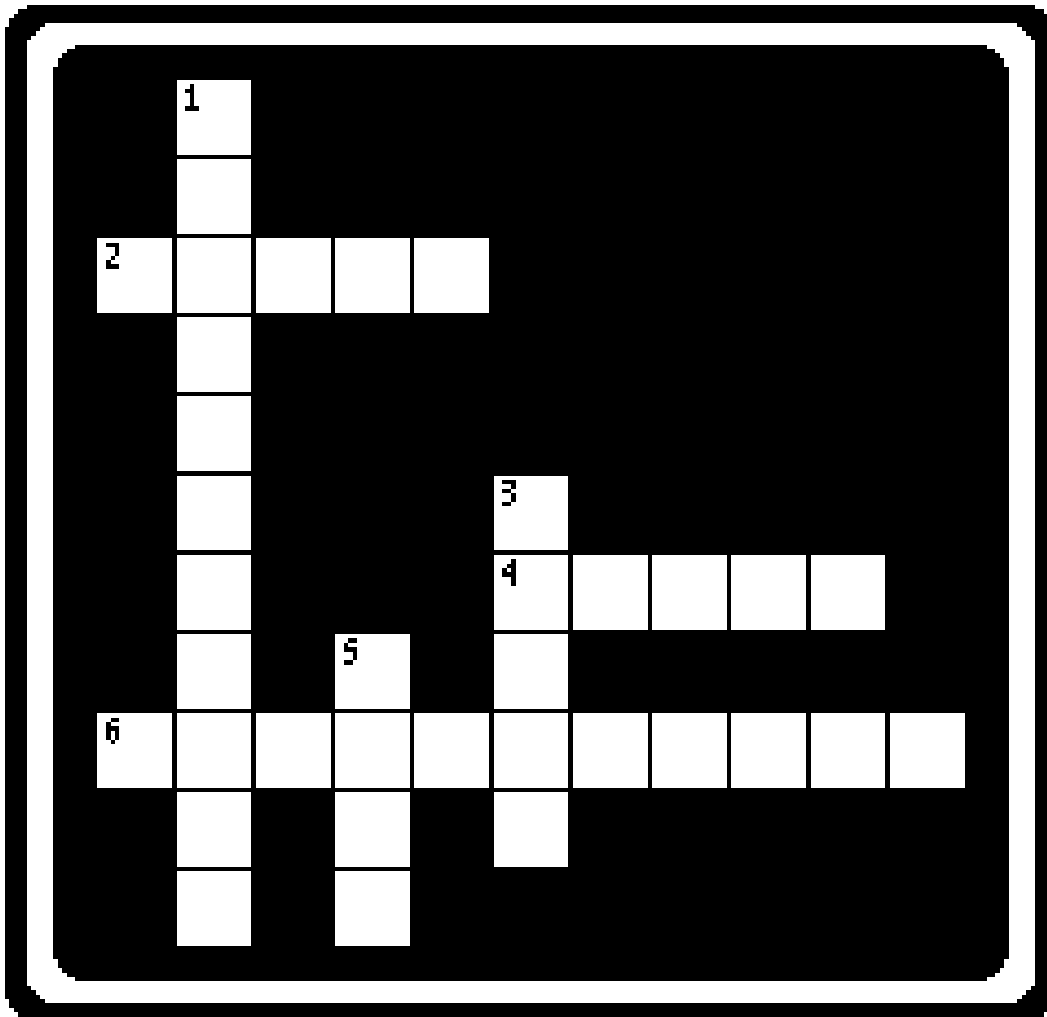

- 4 ACROSS "And you He made _____, who were dead in trespasses and sins." **EPHESIANS 2:1**
- 2 ACROSS "But God, who is rich in mercy, because of His great love with which He loved us, even when we were dead in trespasses, made us alive together with Christ (by _____ you have been saved)." **EPHESIANS 2:4-5**
- 3 DOWN "For by grace you have been saved through _____, and that not of yourselves..." **EPHESIANS 2:8**
- 5 DOWN "...it is the _____ of God, not of works, lest anyone should boast." **EPHESIANS 2:8-9**
- 1 DOWN "For we are His _____..." **EPHESIANS 2:10**
- 6 ACROSS "...created in _____ _____ for good works, which God prepared beforehand that we should walk in them." **EPHESIANS 2:10**

Bible Story 285

OUR CHIEF CORNERSTONE

EPHESIANS 2:19-22

285. OUR CHIEF CORNERSTONE
(EPHESIANS 2:19-22)



"And are built upon the foundation of the apostles and prophets, Jesus Christ himself being the chief corner *stone*;"

EPHESIANS 2:20

285. OUR CHIEF CORNERSTONE

(EPHESIANS 2:19-22)

MEMORY VERSE:

"The stone which the builders rejected has become the chief cornerstone. This was the LORD'S doing; it is marvelous in our eyes." PSALM 118:22-23

TRUE OR FALSE:

1. "Now, therefore, you are no longer strangers, merchants and foreigners, but fellow citizens with the saints and members of the household of God." **EPHESIANS 2:19**
TRUE OR FALSE

CIRCLE THE CORRECT WORDS:

2. "...having been built on the (**FOUNDATION, ROOF**) of the apostles and prophets..."
EPHESIANS 2:20
3. "...Jesus Christ Himself being the chief (**WALL, CORNERSTONE**)."
EPHESIANS 2:20

TRUE OR FALSE:

4. "in whom the whole building, being joined together, grows into a holy temple in the Lord."
EPHESIANS 2:21
TRUE OR FALSE

FILL IN THE BLANK:

5. "in whom _____ also are being built together for a habitation of God in the Spirit."
EPHESIANS 2:22

285. OUR CHIEF CORNERSTONE

(EPHESIANS 2:19-22)

F	S	J	A	S	B	W	P	O	B	E	B	P	O	P
O	O	P	E	P	R	S	B	D	P	Y	O	Z	U	R
V	B	R	I	S	A	E	L	W	C	G	W	L	S	O
B	B	D	E	R	U	R	G	F	T	B	H	E	G	P
O	C	P	N	I	I	S	F	N	O	G	L	B	E	H
K	P	K	H	Y	G	T	C	H	A	T	E	J	J	E
V	K	M	N	H	U	N	A	H	S	R	F	P	I	T
V	Z	B	Y	I	L	M	E	O	R	F	T	W	W	S
S	A	I	N	T	S	L	P	R	B	I	S	S	V	R
R	R	R	G	K	Q	A	J	C	S	R	S	D	L	V
Y	C	O	R	N	E	R	S	T	O	N	E	T	B	B
D	W	W	Q	D	O	G	A	I	B	S	M	B	Z	N
K	N	G	Q	H	N	O	I	T	A	D	N	U	O	F
A	N	T	K	P	Z	C	I	T	I	Z	E	N	S	R
Z	B	I	Q	S	K	R	N	S	C	K	V	M	Y	D

APOSTLES
CITIZENS
CORNERSTONE
FOREIGNERS

FOUNDATION
GOD
JESUSCHRIST
PROPHETS

SAINTS
SPIRIT
STRANGERS

START

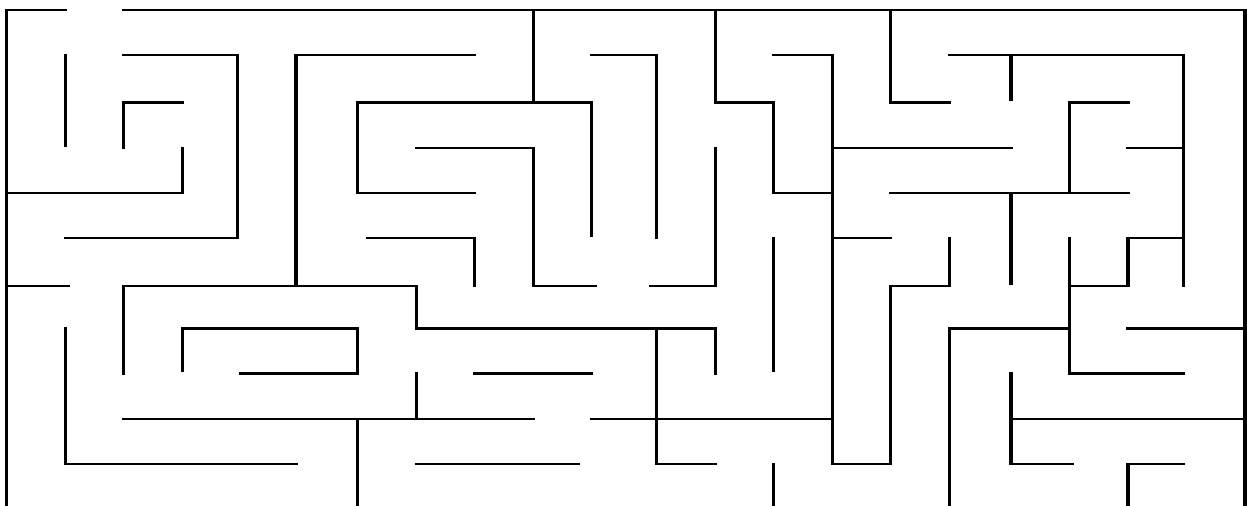

FINISH

285. OUR CHIEF CORNERSTONE

(EPHESIANS 2:19-22)

MEMORY VERSE:

"The stone which the builders rejected has become the chief cornerstone. This was the LORD'S doing; it is marvelous in our eyes." PSALM 118:22-23

TRUE OR FALSE:

1. "Now, therefore, you are no longer strangers, merchants and foreigners, but fellow citizens with the saints and members of the household of God." **EPHESIANS 2:19**
TRUE OR FALSE

FILL IN THE BLANKS:

2. "...having been built on the _____ of the apostles and prophets..."
EPHESIANS 2:20
3. "...Jesus Christ Himself being the chief _____." **EPHESIANS 2:20**

TRUE OR FALSE:

4. "in whom the whole building, being joined together, grows into a holy temple in the Lord."
EPHESIANS 2:21
TRUE OR FALSE

FILL IN THE BLANK:

5. "in whom _____ also are being built together for a habitation of God in the Spirit."
EPHESIANS 2:22

285. OUR CHIEF CORNERSTONE

(EPHESIANS 2:19-22)

Z E D I E J E M E E S G B I W T I T T M Y Q L T H G H F D H
 W Y H N R N H S C U B J L L C J L F E U Z Z E H T V L B E K
 I I R T J K N L J A D D P W B B B N N T O S N E W Y B B W G
 B Q F I J E J G U N N W U S N P U C Y Y C M Y V V E B R E D
 V Y P C G W Y J N L D Y Z H Y L Z B C E U I V E I N T Z Z J
 S K Z V O U G B O B Q H N Y K B U Y O E W C J N N J C A Z B
 B S H S H K K B D Y W S U K I P R Q R N O U G L K K A E E P
 B U S J G P E S W E J M Q E M Z G R N Q R J A Y W K P E H S
 W F T P B W I E S B T K V R I R D F E S H Y G E B A N M R D
 H K N C R Z K L R R U Y I Q T B G V R F Q K I C U D P N V T
 R I V E O K E T R A B O Z K J D H K S F P N I V D H M C Q A
 T Z H B M S I U V G P H S K D O U G T K O B F Q Y A W I P R
 C A N R H Q S D Y T D I L V C G F P O E K O A J Q S M H R D
 H K Y N R V I J B I T Q F B N U F W N O K J S W S Q I P Y Y
 Q W C Q N Z R I D O V K E J U U S Y E H F I F U D M D M P Y
 I B M S N R E I D Y P L I P A R R T L I U B Y B S T A H U R
 W D R P Z D B U I M T Z H U T L I U B G F E V E G U E M I P
 T X C Z Y R N G N B D M C V G W Z Y A O H G L J O D N E Q R
 L R B B Z C P Z B W P M C B M G W Q U M S F L N N M P G R O
 J H C K K N V E F S U N K M F G N N N D E B M E H S Y N K P
 D Z F E B Y W G N N T K W V V L D Q Z Z B V O T Q B Q H C H
 U B E V G I W M J S Q F Q S S A B N Q N F W M T H Q A H V E
 J V B K Z R N S M I L A X A T N B V C S Z H V Q A V Q E I T
 U B Q E L P D O T M Y E P I J K K Q P I S W Z O I Y Y F J S
 H J Q W K H F H P M I O O E I Y N D W V Q Q Y N J T A C S W
 T R R B J B E K Y Z S N G B S B O A R W G I G S B N N S U B
 N K V K P Y A T K T G F E U B B C N A P H B C U O V D N D Q
 T P Q K N D W A L K Q Q S J V K H E B C C F E M C H C Z S E
 V L M W N K A E W J I E N P D U Z T S I R H C Z F K G H Z R
 F M L Y F S S S Y Y J B D W V Q M V W P B U N Y D M O M Y D

FIND THE WORDS OF THE SCRIPTURE BELOW IN THE PUZZLE ABOVE

*"Having been built on the foundation of the apostles and prophets,
 Jesus Christ Himself being the chief cornerstone."*

EPHESIANS 2:20

285. OUR CHIEF CORNERSTONE

(EPHESIANS 2:19-22)

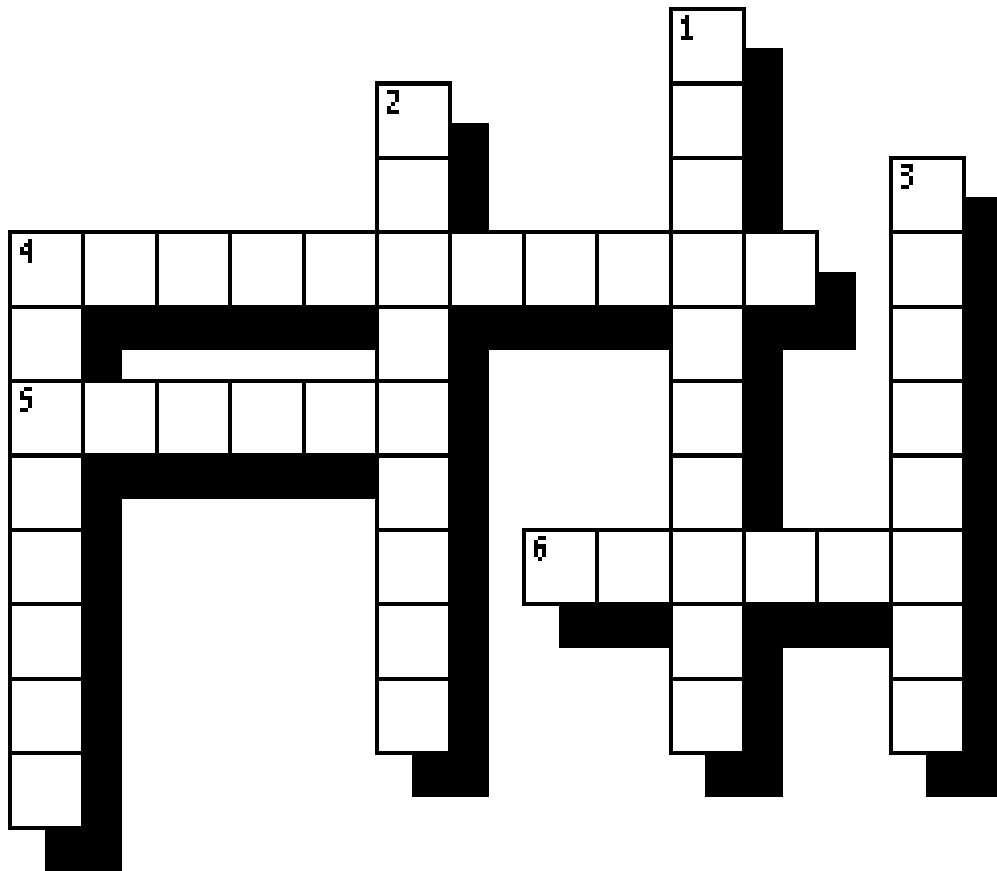

- 3 DOWN *"The stone which the builders _____ has become the chief cornerstone." PSALM 118:22-23*
- 2 DOWN *"This was the LORD'S doing; it is _____ in our eyes." PSALM 118:22-23*
- 4 DOWN *"Now, therefore, you are no longer strangers, merchants and foreigners, but fellow _____ with the saints and members of the household of God." EPHESIANS 2:19*
- 1 DOWN *"...having been built on the _____ of the apostles and prophets..." EPHESIANS 2:20*
- 4 ACROSS *"...Jesus Christ Himself being the chief _____." EPHESIANS 2:20*
- 5 ACROSS *"in whom the whole building, being joined together, grows into a holy _____ in the Lord." EPHESIANS 2:21*
- 6 ACROSS *"in whom you also are being built together for a habitation of God in the _____." EPHESIANS 2:22*

Bible Story 286

**THE
WHOLE ARMOR
OF GOD**

EPHESIANS 6:10-20

286. THE WHOLE ARMOR OF GOD (EPHESIANS 6:10-20)



"Finally, my brethren, be strong in the Lord, and in the power of his might.
Put on the whole armour of God, that ye may be able to stand against the wiles of the devil."

EPHESIANS 6:10-11

286. THE WHOLE ARMOR OF GOD

(EPHESIANS 6:10-20)

MEMORY VERSE:

"Put on the whole armor of God, that you may be able to stand against the wiles of the devil." EPHESIANS 6:11

CIRCLE THE CORRECT WORDS:

1. "Finally, my brethren, be (**STRONG, WEAK**) in the Lord and in the power of His might."
EPHESIANS 6:10
2. "Put on the whole (**COSTUME, ARMOR**) of God, that you may be able to stand against the wiles of the devil." EPHESIANS 6:11

TRUE OR FALSE:

3. "For we do not wrestle against flesh and blood..." EPHESIANS 6:12
TRUE OR FALSE

CIRCLE THE CORRECT WORD:

4. "Therefore take up the whole armor of God, that you may be able to withstand in the evil day, and having done all, to (**STAND, FALL**)."
EPHESIANS 6:13

TRUE OR FALSE:

5. "Stand therefore, having girded your waist with truth, having put on the breastplate of righteousness, and having shod your feet with the preparation of the gospel of peace."
EPHESIANS 6:14-15
TRUE OR FALSE

CIRCLE THE CORRECT WORD:

6. "Above all, taking the shield of (**IRON, FAITH**) with which you will be able to quench all the fiery darts of the wicked one." EPHESIANS 6:16

TRUE OR FALSE:

7. "And take the helmet of salvation, and the sword of the Spirit, which is the word of God; praying always with all prayer and supplication in the Spirit..." EPHESIANS 6:17
TRUE OR FALSE

286. THE WHOLE ARMOR OF GOD

(EPHESIANS 6:10-20)

T P I P O J W K S I U Y U J N
R Y P B I K E U S T M M Y I N
U P G B B R E A S T P L A T E
T A D Z C M C S E E H T W F Y
H L N A Y Q V H N D R O W S B
O D Y Z Q B G L S C B D B V V
I D L E I H S B U T K R C A V
J A E C A E P F O L E P S O G
S P T T K C Q Y E F D E Y F Q
K M S S O R V P T P B N F O F
W O I E P A W J H M B I B F A
V G A G K I Q K G M C G B D I
H T W G E A R J I H E L M E T
B V G T C L Z I R B B A W Y H
O U W U F S T W T L F B B I P

BREASTPLATE
FAITH
FEET
GOSPEL OF PEACE

HELMET
RIGHTEOUSNESS
SHIELD
SPIRIT

SWORD
TRUTH
WAIST

ENTER

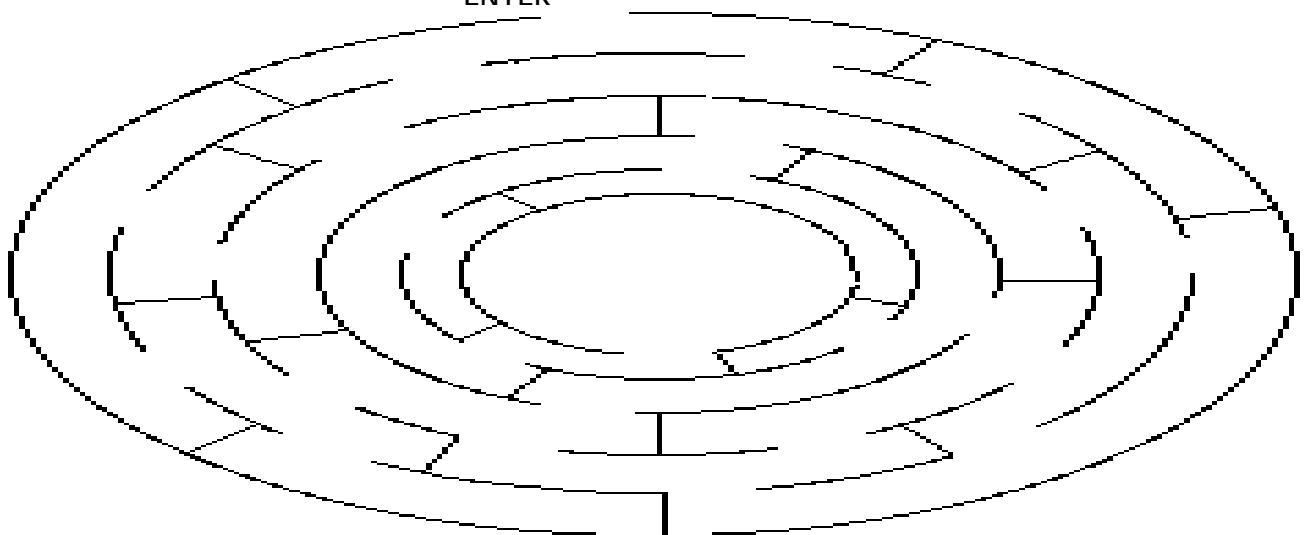

286. THE WHOLE ARMOR OF GOD

(EPHESIANS 6:10-20)

MEMORY VERSE:

"Put on the whole armor of God, that you may be able to stand against the wiles of the devil." EPHESIANS 6:11

FILL IN THE BLANKS:

1. "Finally, my brethen, be _____ in the Lord and in the power of His might."
EPHESIANS 6:10
2. "Put on the whole _____ of God, that you may be able to stand against the wiles of the devil." **EPHESIANS 6:11**

TRUE OR FALSE:

3. "For we do not wrestle against flesh and blood..." **EPHESIANS 6:12**
TRUE OR FALSE

FILL IN THE BLANK:

4. "Therefore take up the whole armor of God, that you may be able to withstand in the evil day, and having done all, to _____." **EPHESIANS 6:13**

MATCHING:

EPHESIANS 6:14-17

- | | |
|-------------------------------------|--------------------|
| 5. _____ Gird your waist with (v14) | a. righteousness |
| _____ Breastplate of (v14) | b. salvation |
| _____ Shod your feet with (v15) | c. Spirit |
| _____ Shield of (v16) | d. Truth |
| _____ Helmet of (v17) | e. gospel of peace |
| _____ Sword of the (v17) | f. faith |

FILL IN THE BLANK:

6. "...praying _____ with all prayer and supplication in the Spirit..." **EPHESIANS 6:18**

286. THE WHOLE ARMOR OF GOD (EPHESIANS 6:10-20)

L Z Y T N Z W O J D D Y U W Y M I C Q C N B N L H Y D X J S
 B T N F O D V W H U E H I N N B D R E J W J G H I J K J L E
 I F K W H E Z P V K C W B O U B V L S D Z M I B D W L R B J
 U Y K Y M E Z Y F L K N T U Z M E V V F S U F W D J Q I B G
 F D W F Z D M V O R W O O H U M I F X K W N H F K B I Q J E
 G O I E D C M Z P T C F A G I E K C J V R K Y K T K W N W J
 S W J D C C M Y U A O A Z F R O A K P Y Z U I B T F B S X P
 W S Q R V L I S U L W R H B V Z D B A R K V B E A W I P A O
 B R L L E G B S R E O B Q R B O J D R H A W S N H S H G S B
 T Z H S K G O O D S H T W T I J T C B W H E D W R C R O V P
 G B U B N B J I Y K E T I F V D B E L M F M L Q X M R O L D
 A C G H B A U B M J U W Y Q V E W Z E Q A Y G K C F D T I E
 Z H I F Z V I K D B U B M P O B D K Q A D C H L J O Z Q Y I
 B J N D B S B S B R E A H Y Y Y N B U L K K C B X S P T Q K
 E L T D O S O G E Q H N W Z K J A V N O T S Y R Y B R L F G
 K E M V T F Y L B H P P N I G T T Q H F B H T S N I A G A T
 A O L D H A D O Y C P U E N O W S W N G Q G E K R J B P Q M
 O O N M A G D M E O B E T Q E H C B H I P C U Z B G Y W Q S
 A W T V T E O L A C K M L V N A L B E C A F U E E O G W D E
 Y J H P V V A D O G F Y I A U U P R J T J R P R G T I V J K
 L A T I R S U T I C S H Z B Z I I T P T Z B M R I L N P O I
 G G L T B W Q O A C Q C J F P C I A L E J D S O E D G S H G
 H F P I B A N B Y B V G Y E H W U M U A D P W S R Q B L R I
 I F N H T W L T W T H D K R B Q O M C P D I A V B B B R L O
 J B C N C E C J Y E K J B I S A Y Q K C P F K B R K V E Y Z
 W V B N N W N T M J P D F J P R W S G G S M B J V A A R J K
 E W F S P Z L H R M W O Y N J R F R S G V M S S I U J T J Z
 W Q O K O O B H F H G F Z A Y W S S Z R D P V S N T A B H F
 I T V Y J B C G Z O Q W M W M Y R F Z B S T O K Q P O P C E
 Z C M L T A E J I P V D S E V M N C L S U A F P I G I V H A

FIND THE WORDS OF THE VERSE BELOW IN THE PUZZLE ABOVE

"Put on the whole armor of God, that you may be able to stand against the wiles of the devil." EPHESIANS 6:11

ENTER

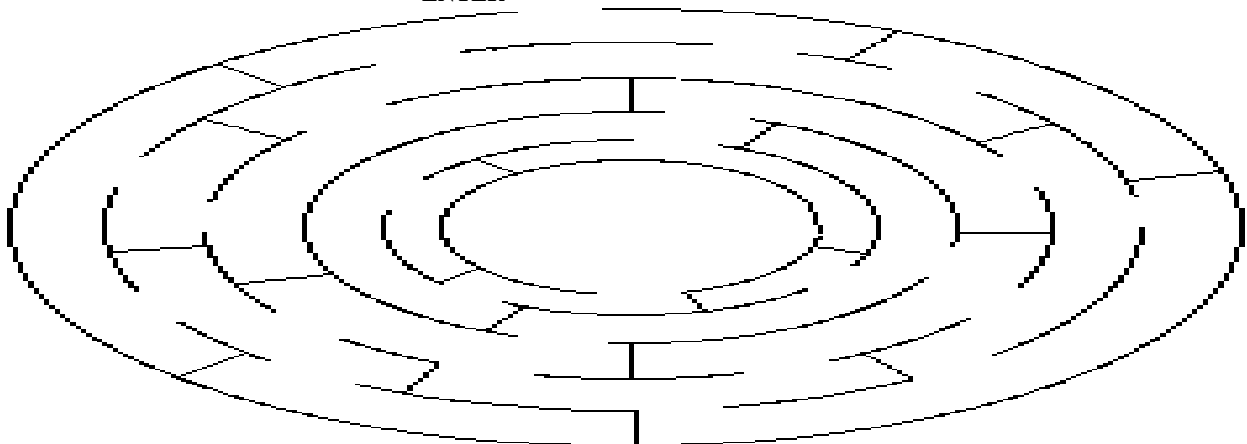

286. THE WHOLE ARMOR OF GOD

(EPHESIANS 6:10-20)

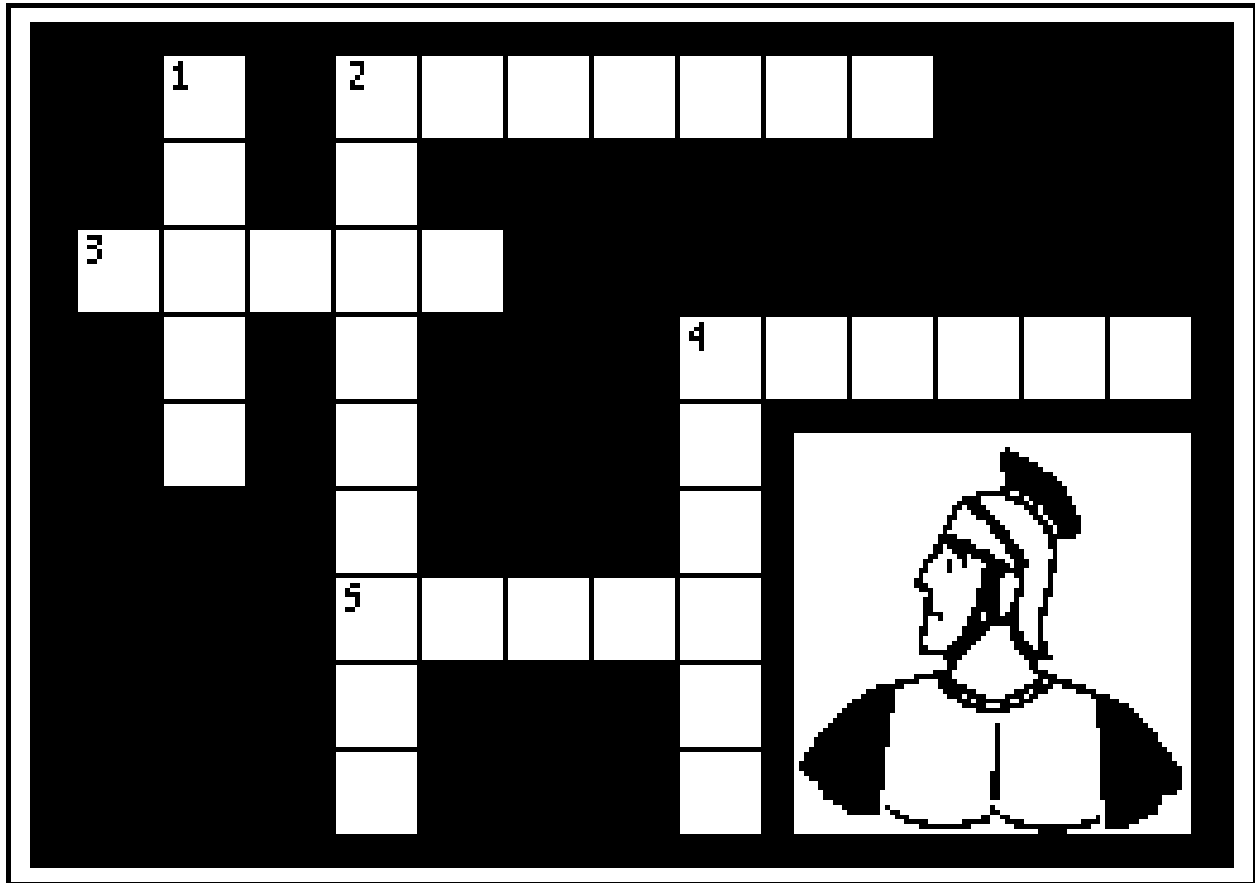

- 4 ACROSS "Finally, my brethren, be _____ in the Lord and in the power of His might." **EPHESIANS 6:10**
- 5 ACROSS "Put on the whole _____ of God, that you may be able to stand against the wiles of the devil." **EPHESIANS 6:11**
- 2 ACROSS "For we do not _____ against flesh and blood..." **EPHESIANS 6:12**
- 2 DOWN "Therefore take up the whole armor of God, that you may be able to _____ in the evil day, and having done all, to stand." **EPHESIANS 6:13**
- 1 DOWN "_____ therefore, having girded your waist with truth, having put on the breastplate of righteousness, and having shod your feet with the preparation of the gospel of peace." **EPHESIANS 6:14-15**
- 3 ACROSS "Above all, taking the shield of _____ with which you will be able to quench all the fiery darts of the wicked one." **EPHESIANS 6:16**
- 4 DOWN "And take the helmet of salvation, and the sword of the Spirit, which is the word of God; praying always with all prayer and supplication in the _____..." **EPHESIANS 6:17**

Bible Story 287

**THE EXCELLENCE
OF THE KNOWLEDGE
OF CHRIST**

PHILIPPIANS 3:3-11

287. THE EXCELLENCE OF THE KNOWLEDGE OF CHRIST
(PHILIPPIANS 3:3-11)

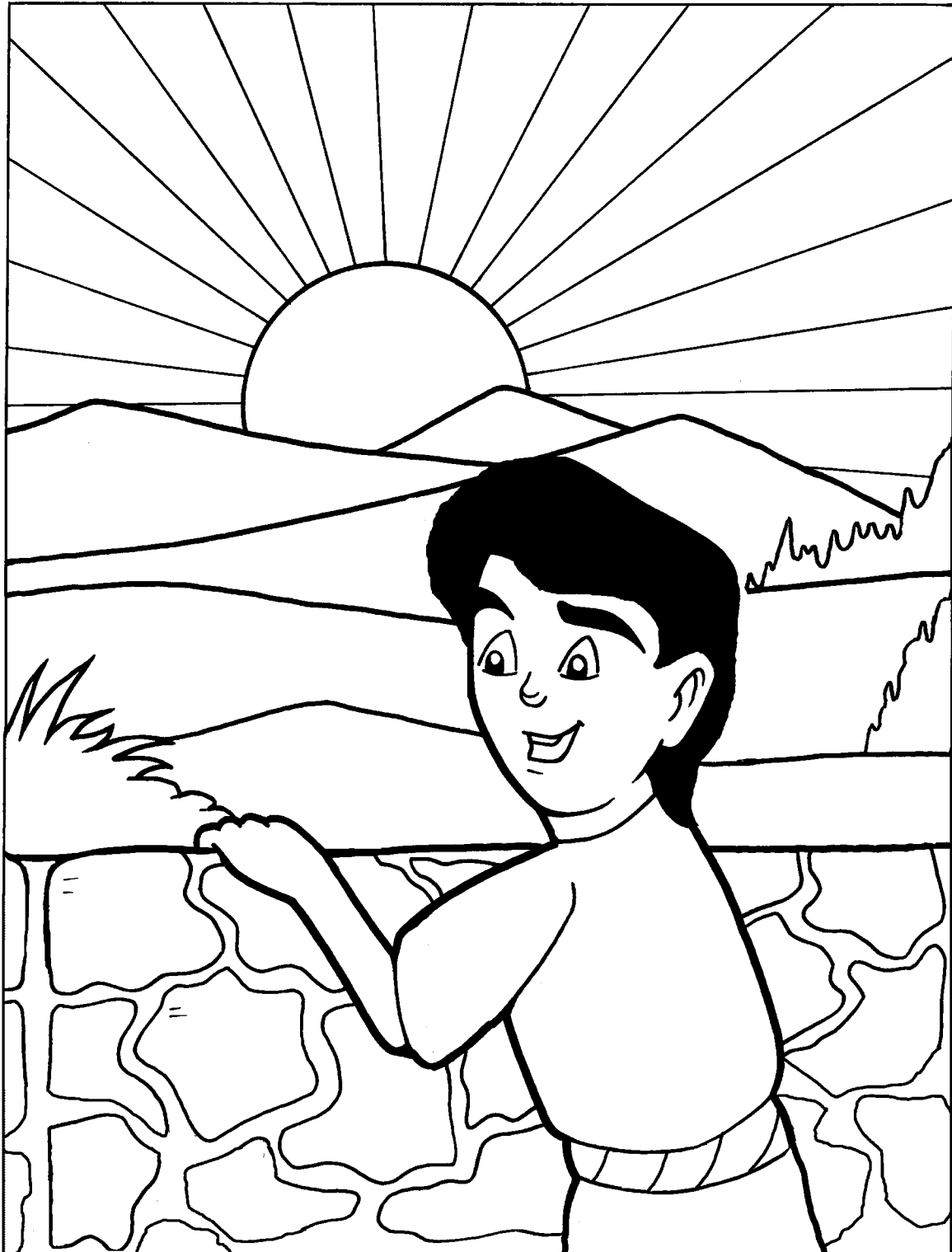

"But indeed I also count all things for loss for the
excellence of the knowledge of Christ Jesus my Lord..."

PHILIPPIANS 3:8

287. THE EXCELLENCE OF THE KNOWLEDGE OF CHRIST

(PHILIPPIANS 3:3-11)

MEMORY VERSE

"But indeed I also count all things for loss for the excellence of the knowledge of Christ Jesus my Lord..." PHILIPPIANS 3:8

Paul writes...

TRUE OR FALSE:

1. "But what things were gain to me, these things I have counted loss for Christ."
PHILIPPIANS 3:7
TRUE OR FALSE
2. "But indeed I also count all things loss for the excellence of the knowledge of Christ Jesus my Lord..." **PHILIPPIANS 3:8**
TRUE OR FALSE

CIRCLE THE CORRECT WORDS:

3. "...for whom I have suffered the loss of all things, and count them as (**RUBBISH, NUMBERS**), that I may gain Christ." **PHILIPPIANS 3:8**
4. "...and be found in Him, not having my own righteousness, which is from the law, but that which is through faith in Christ, the righteousness which is from God by (**FAITH, WORKS**)."
PHILIPPIANS 3:9

TRUE OR FALSE:

5. "...that I may know Him and the power of His resurrection, and the fellowship of His sufferings..." **PHILIPPIANS 3:10**
TRUE OR FALSE

287. THE EXCELLENCE OF THE KNOWLEDGE OF CHRIST

(PHILIPPIANS 3:3-11)

Z O E E C I O J E R U B R G Y
 G L V A H E V Q P W Y D O D K
 K N O W L E D G E R K D T V B
 C P J P D Z J W K N B P B V Y
 S E D N I S Y O B D F M C K O
 V B G Y S S O L D E T N U O C
 V C R E S U R R E C T I O N U
 L E R I G H T E O U S N E S S
 I L R E E M R K P J Z J Y O Q
 C L R U E O S L E L W I Z U B
 K E B L B P S S F O B Y K F M
 R N W Q I B U G A J I P R V T
 M C R R M S I V Z V Z S D U N
 V E I W B U S S E L E M A L B
 N T V C B O Z V H T S I R H C

BLAMELESS
 CHRIST
 COUNTED LOSS
 EXCELLENCE

GOD
 JESUS
 KNOWLEDGE
 REJOICE

RESURRECTION
 RIGHTEOUSNESS
 RUBBISH
 SPIRIT

START

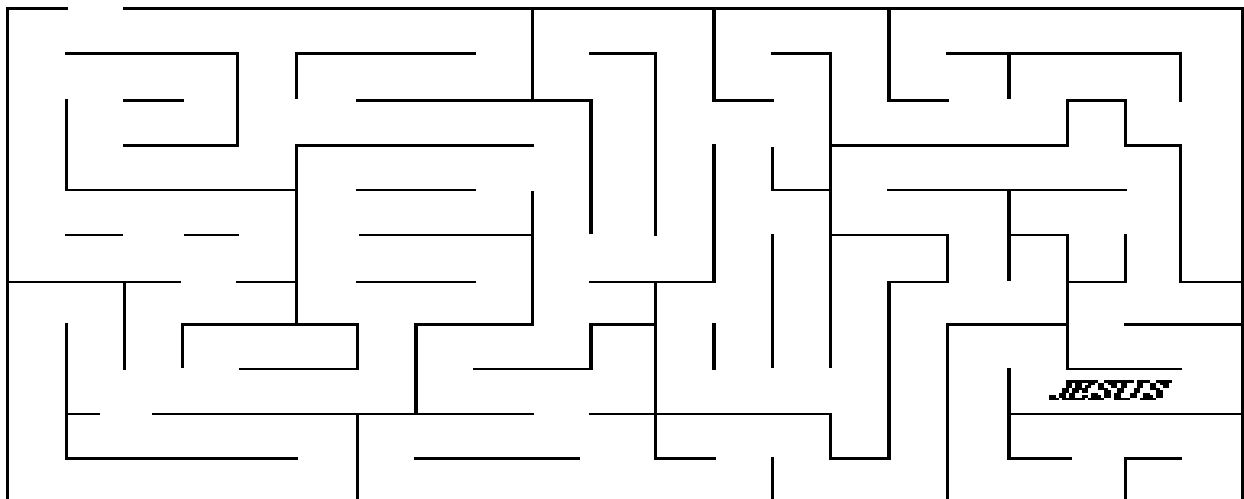

287. THE EXCELLENCE OF THE KNOWLEDGE OF CHRIST

(PHILIPPIANS 3:3-11)

MEMORY VERSE

"But indeed I also count all things for loss for the excellence of the knowledge of Christ Jesus my Lord..." PHILIPPIANS 3:8

Paul writes...

TRUE OR FALSE:

1. "But what things were gain to me, these things I have counted loss for Christ."
PHILIPPIANS 3:7
TRUE OR FALSE
2. "But indeed I also count all things loss for the excellence of the knowledge of Christ Jesus my Lord..." **PHILIPPIANS 3:8**
TRUE OR FALSE

FILL IN THE BLANKS:

3. "...for whom I have suffered the loss of all things, and count them as _____, that I may gain Christ." **PHILIPPIANS 3:8**
4. "...and be found in Him, not having my own righteousness, which is from the law, but that which is through faith in Christ, the righteousness which is from God by _____."
PHILIPPIANS 3:9

TRUE OR FALSE:

5. "...that I may know Him and the power of His resurrection, and the fellowship of His sufferings..." **PHILIPPIANS 3:10**
TRUE OR FALSE

287. THE EXCELLENCE OF THE KNOWLEDGE OF CHRIST

(PHILIPPIANS 3:3-11)

A Y K O K B V C H T V M Q O N N U I T B I V P H Z K U V L P
 R O B B L L U L Y V F B W F F B V F S B W G Z C J L A O R Z
 K F D K D O D W Y G I U G U G L C J T K A U B H Q W R B Z I
 H G C E F U W C M W U V B D I L G Q O N M B B L B D M C B C
 I Q Z Y A P E A B D H E W I E D O E Y P H J P U M B Q U I B
 T C R T B W E A P K I Z D V G N Q P T F L W T A G K P E A K
 J F D E R C L Z R A T S I R H C A G T H A S S B J N B T B L
 H C Y Z B L B S Y G P U I E W K E G G K Z B A G E I T N N W
 B J Q Q O P D D R S K U T M K A G L N J Y Z W D S I H R V F
 C K Q V F R V G E A R I H N O U A O F K E Z I V U C J G A I
 G V H A E T N P E C E B E B I W W Y I Z K E L Z S J M Q O W
 H O L L W N M Y R U N Q C A L L T T Y W G S V Y B H U A W K
 G S F S G U P C V K N E T S E K N P M W Z G U O T M N F E O
 O B O R F O Y V T S A U L D D Y B V L O S S A H H U N W T W
 Q Y I S Z C G U O Y B B G L S Y K E R V S Y I R P J R E E F
 P D H B A F N I J B I E P P E E L N A H B N G C N H S J P U
 C G H B N M W P Q F P V L W U C D J U W G M O C Z G C N C A
 P C Q Z S I Y N L L Q B O J J H B A V S E B J U P Q R Q V H
 Q B U F H E Z S P K F W P S L L O E W S W O D B A J G A T O
 B E F W U T U C V I R Y D N J B H H A R G I N D E E D B S D
 V B U B S L G N G Q C U Q A T R Y N T V B L E R K W W M B X
 L Y M Y Y M F P Y F O K J I B O Q Y Z B T F Q B W L K M Q K
 I E N L J E Y C Q S G Y J P V W K W V K D W W P O Q G J B S
 J B H N N Z I B D S O H C P Q H G C K G P U D I Y P Q L M L
 C Z V T R I F C O O W F B I O J O N B P T U U Y K W N F I Z
 J U S D O I B B O E J Q V L V S J R M E C Y A V Z E G Z T I
 H F L C F D L P K Z V B D I Y R M G S I P O B N U T H A N C
 L J B V D Z A R P P H H I H B V N I H N N L C W M F W P B D
 Q U M O Y P E E Z E Y M M P C J R K J A B P Q E P O Z M P C
 H B I S I Z Z M S U G G O H J D M F L V I Z K H G R G B Y Q

FIND THE WORDS OF THE SCRIPTURE BELOW IN THE PUZZLE ABOVE

"But indeed I also count all things loss for the excellence of the knowledge of Christ Jesus my Lord." PHILIPPIANS 3:8

START

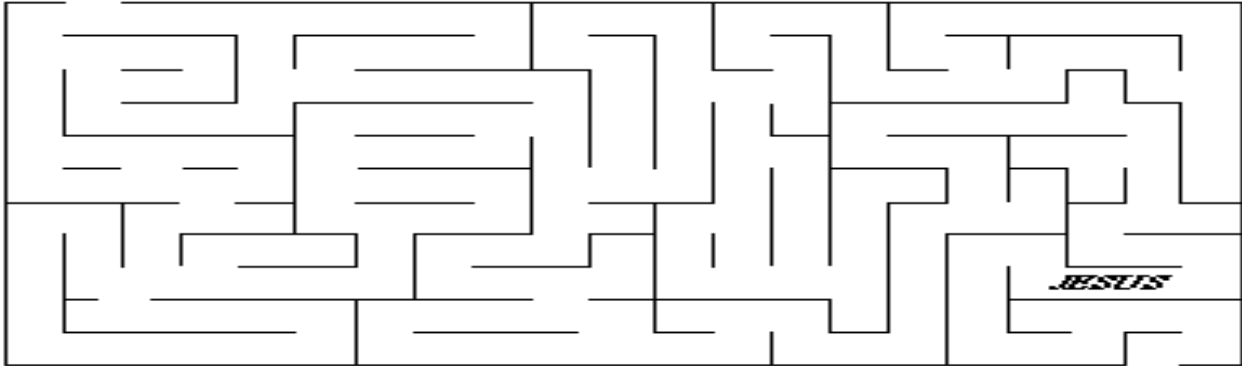

287. THE EXCELLENCE OF THE KNOWLEDGE OF CHRIST (PHILIPPIANS 3:3-11)

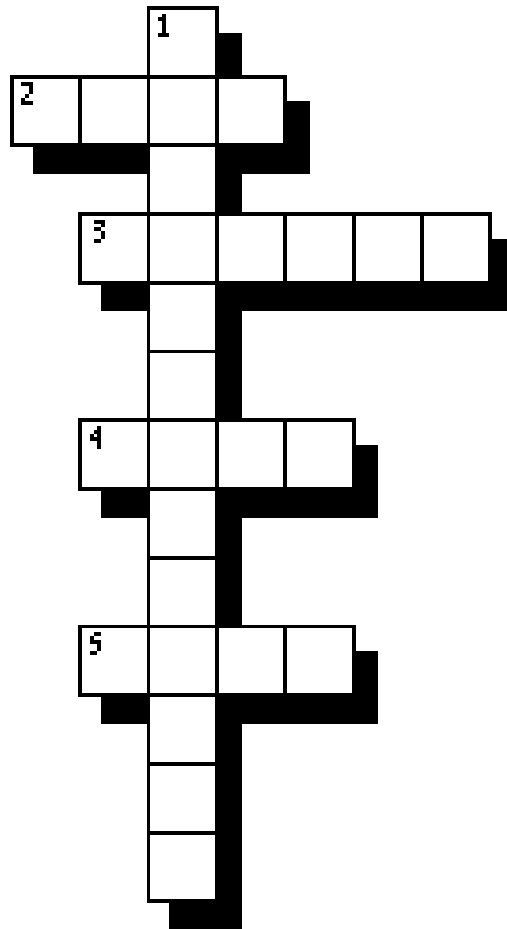

- 3 ACROSS "But what things were gain to me, these things I have counted loss for ____." **PHILIPPIANS 3:7**
- 4 ACROSS "But indeed I also count all things ____ for the excellence of the knowledge of Christ Jesus my Lord..."
PHILIPPIANS 3:8
- 2 ACROSS "...for whom I have suffered the loss of all things, and count them as rubbish, that I may ____ Christ."
PHILIPPIANS 3:8
- 1 DOWN "...and be found in Him, not having my own righteousness, which is from the law, but that which is through faith in Christ, the ____ which is from God by faith." **PHILIPPIANS 3:9**
- 5 ACROSS "...that I may ____ Him and the power of His resurrection, and the fellowship of His sufferings..."
PHILIPPIANS 3:10

Bible Story 288

**THE
CHRISTIAN
HOME**

COLOSSIANS 3:18-4:6



"Children, obey your parents in all things,
for this is well pleasing to the Lord."
COLOSSIANS 3:20

288. THE CHRISTIAN HOME (COLOSSIANS 3:18-4:6)

MEMORY VERSE:

"Children, obey your parents in all things, for this is well pleasing to the Lord."
COLOSSIANS 3:20

TRUE OR FALSE:

1. "Wives, submit to your own husbands, as is fitting in the Lord." **COLOSSIANS 3:18**
TRUE OR FALSE
2. "Husbands, love your wives and do not be bitter toward them." **COLOSSIANS 3:19**
TRUE OR FALSE
3. "Children, obey your parents in all things, for this is well pleasing to the Lord."
COLOSSIANS 3:20
TRUE OR FALSE
4. "Fathers, do not provoke your children, lest they become discouraged." **COLOSSIANS 3:21**
TRUE OR FALSE
5. "Servants, obey in all things your masters according to the flesh, not with eye-service, as men-pleasers, but in sincerity of heart, fearing God." **COLOSSIANS 3:22**
TRUE OR FALSE

CIRCLE THE CORRECT WORDS:

6. "And whatever you do, do it (**HEARTILY, HALF-HEARTEDLY**) as to the Lord and not to men, knowing that from the Lord you will receive the reward of inheritance; for you serve the Lord Jesus Christ." **COLOSSIANS 3:23-24**
7. "Continue earnestly in (**EATING, PRAYER**), being vigilant in it with thanksgiving."
COLOSSIANS 4:2
8. "Walk in (**WISDOM, FOOLISHNESS**) toward those who are outside, redeeming the time."
COLOSSIANS 4:5

288. THE CHRISTIAN HOME

(COLOSSIANS 3:18-4:6)

F I A Y P I D N U Z P C M T K
S L N J R I I P G C C B B O P
W D S Y F D N Y F L V C P J Z
B F O N M G N I S A E L P Q S
Y U H D S L O R D A U B R L T
R A S Y W N W G L W I P Y P V
L B T I E E A L Y T H I N G S
N R N B T Z L I I C P R R V G
D B E L L T E L S A N E E G W
C E R O O P E N F S S M H Y D
V W A U Y E B O B Z O H T Q K
S G P P M Z B W L S C L E D F
O I U W N E R D L I H C O O O
S F H C E V D Y A D N Y B C R
K Z S T Z U V Z E G P Y V O A

FIND ALL OF THE WORDS BELOW IN THE PUZZLE ABOVE

"Children, obey your parents in all things, for this is well pleasing to the Lord." COLOSSIANS 3:20

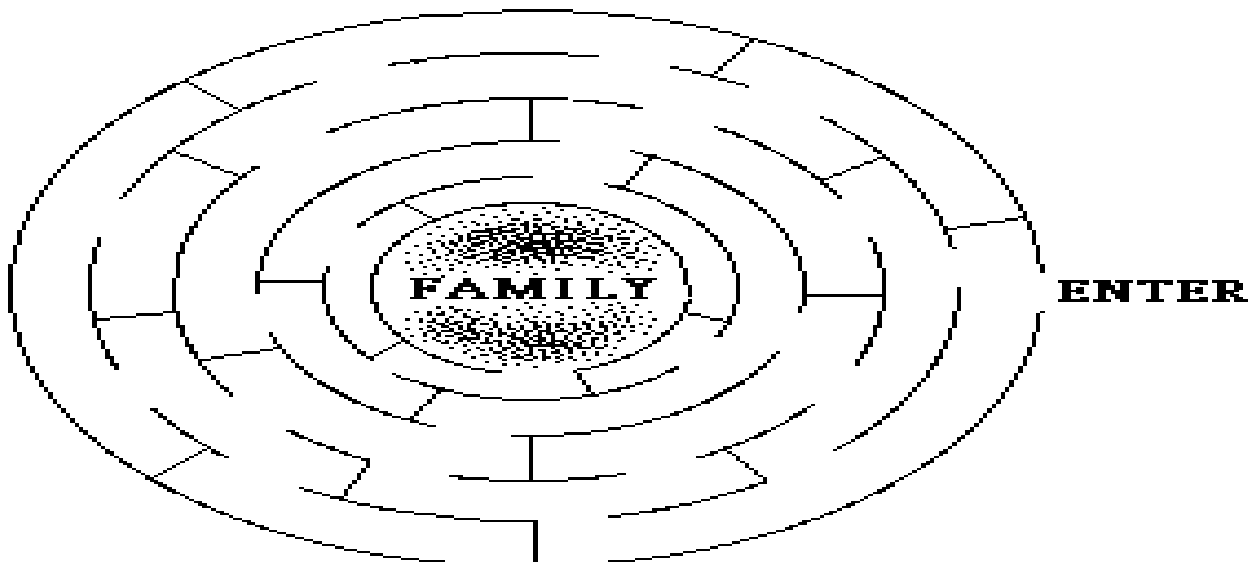

288. THE CHRISTIAN HOME (COLOSSIANS 3:18-4:6)

MEMORY VERSE:

"Children, obey your parents in all things, for this is well pleasing to the Lord."
COLOSSIANS 3:20

TRUE OR FALSE:

1. "Wives, submit to your own husbands, as is fitting in the Lord." **COLOSSIANS 3:18**
TRUE OR FALSE
2. "Husbands, love your wives and do not be bitter toward them." **COLOSSIANS 3:19**
TRUE OR FALSE
3. "Children, obey your parents in all things, for this is well pleasing to the Lord."
COLOSSIANS 3:20
TRUE OR FALSE
4. "Fathers, do not provoke your children, lest they become discouraged." **COLOSSIANS 3:21**
TRUE OR FALSE
5. "Servants, obey in all things your masters according to the flesh, not with eye-service, as men-pleasers, but in sincerity of heart, fearing God." **COLOSSIANS 3:22**
TRUE OR FALSE

FILL IN THE BLANKS:

6. "And whatever you do, do it _____ as to the Lord and not to men, knowing that from the Lord you will receive the reward of inheritance; for you serve the Lord Jesus Christ."
COLOSSIANS 3:23-24
7. "Continue earnestly in _____, being vigilant in it with thanksgiving."
COLOSSIANS 4:2
8. "Walk in _____ toward those who are outside, redeeming the time."
COLOSSIANS 4:5

288. THE CHRISTIAN HOME

(COLOSSIANS 3:18-4:6)

W U B T T Y M C K G G P E U V H A I I U B I Q D F O Q I U B
 Q Z S F P G S S B I W M O O V E I T J K Q H D Y Z N A L S V
 O H S G S H O L S C H W J B T N R B I Y J V Y N R R E N O S
 R Z O J J S A S H N H L S M L P O I J F C M C B F L D D K D
 G M V W V E L N P E B G Z G C T N U B D A E Z P M B B G S R
 C U Z J D Q K P P B B S N Q M L T K B Q S Y Y H C D I W J F
 I D D H T M N M N P B Z W O G Z V B R N B Y S Q R V Z Z F N
 G D C G T B M N E U U S I T K T B B B L L E W O I Z F T R V
 U V B B Q B G Q R U L R N H M T K F Q N W S V Z P R H A C V
 K V O A F C G Q D R Y O O A P B C T K F D Q B F Z I A K R B
 N L P B N B T H L J L J V K I S O A N Y I K T L N T H I S W
 R C O H F B E V I Z H L M W E S E Y L I A Y G G V K K Z L J
 F L R P T Y L Z H F B L G W I M S B E V J J S Q Q E Q E S B
 J V J T H U S B C J K A D B P H U O S Y T P H P Q Q G S A P E
 L N Y Q D W V D R F B G Y L L V Z C L B L A Q S U I W H E D
 F M M B T D P F B E B E O R E Y B M Z O N V Z B S V Y V F C
 Z J G O N O Z H N O B H T Q P B Y U R F C T T R D M U L Z V
 V C B N Y K S G G O D G C C K L E O L P J P O U E V F V L H
 K M B C B J M U B R O N U R S M Q A U N O F W D B O I R V H
 C Y O B P Q B Q L I F W V H N E A K U R I G V Z B V E E O A
 D S V B B B A J L Y B B N N U J L I C G N I S A E L P R L H
 Q O V I U Z K V N S Q W V N W L B L R I M F B O U O O T Z B
 L J R F L L I Q B Y R B M V S D F O K D U K W B Q F Z Q J E
 O I F A N P O D Z D K V S G C Z H Z G L Z K M U J B E S P U
 J M W W Z Q Y R S Y D B T R T P V I W G D O V O A J R W E D
 W O P B H L T D D B F H N K P L E J T R C C Z B D T H E N J
 Z Y W B R A F D V O H C E Z M E L Z D A A T Q T I Y I S R T
 N D V Y A I Z V M J L O R L S B L A C F B N B L O T Y J B Q
 Z V G K A L S V O C D Y A B D L C T V W F B U R B B M R I B
 C U J Y J L B D N V I K P I Q I J T S V L U W F E H S Q R U

FIND ALL OF THE WORDS BELOW IN THE PUZZLE ABOVE

"Children, obey your parents in all things, for this is well pleasing to the Lord." COLOSSIANS 3:20

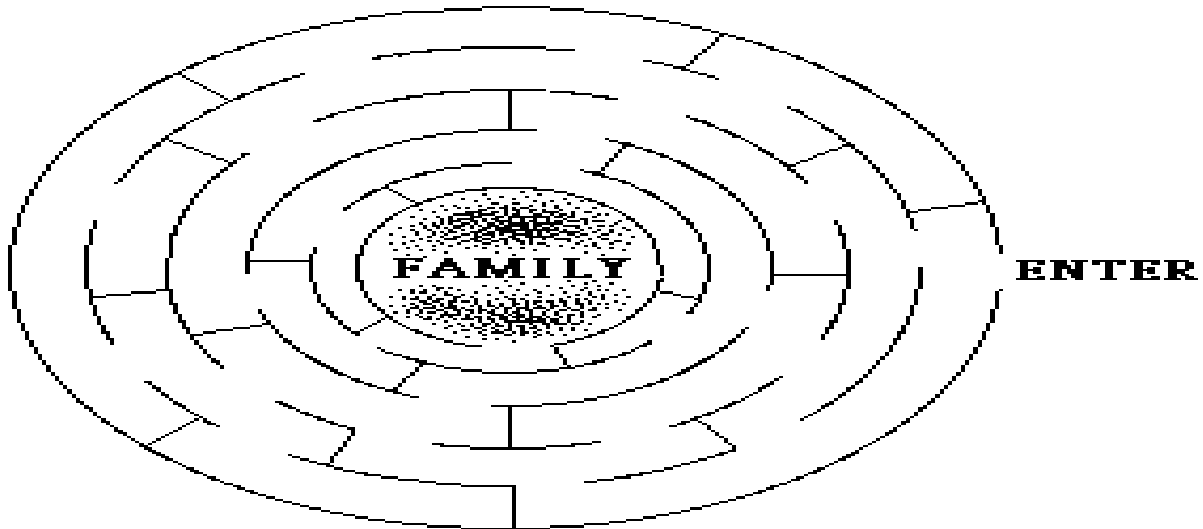

288. THE CHRISTIAN HOME (COLOSSIANS 3:18-4:6)

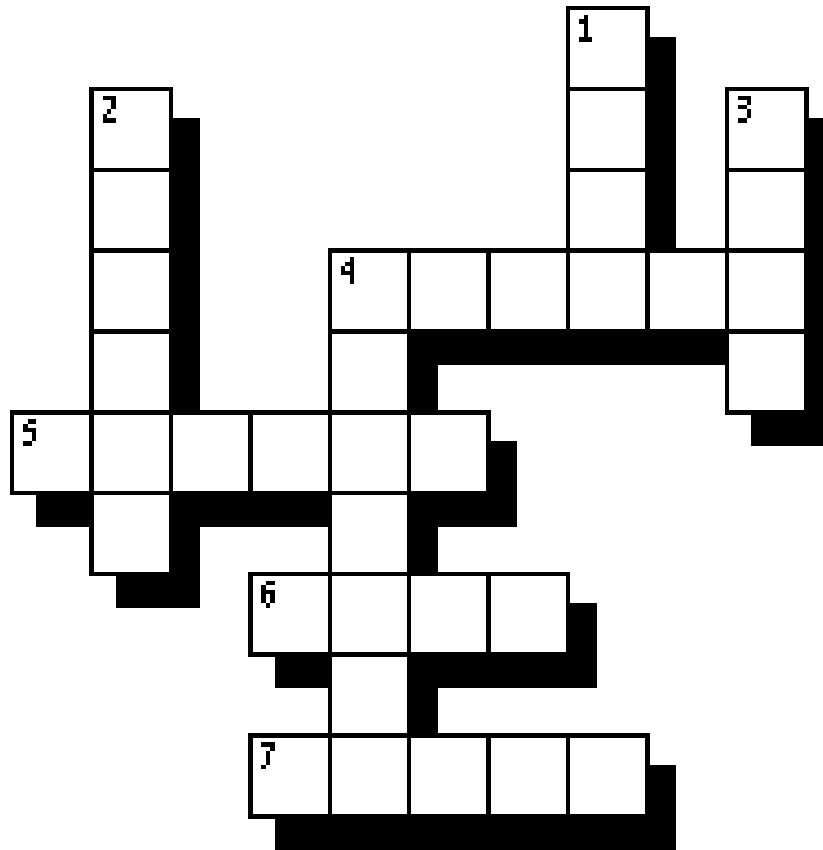

- 2 DOWN "Wives, _____ to your own husbands, as is fitting in the Lord." **COLOSSIANS 3:18**
- 6 ACROSS "Husbands, _____ your wives and do not be bitter toward them." **COLOSSIANS 3:19**
- 1 DOWN "Children, _____ your parents in all things, for this is well pleasing to the Lord."
COLOSSIANS 3:20
- 4 DOWN "Fathers, do not _____ your children, lest they become discouraged." **COLOSSIANS 3:21**
- 7 ACROSS "Servants, obey in all things your masters according to the flesh, not with eye-service, as men-pleasers, but in sincerity of _____, fearing God." **COLOSSIANS 3:22**
- 3 DOWN "And whatever you do, do it heartily as to the _____ and not to men, knowing that from the Lord you will receive the reward of inheritance; for you serve the Lord Jesus Christ." **COLOSSIANS 3:23-24**
- 4 ACROSS "Continue earnestly in _____, being vigilant in it with thanksgiving." **COLOSSIANS 4:2**
- 5 DOWN "Walk in _____ toward those who are outside, redeeming the time." **COLOSSIANS 4:5**

Bible Story 289

THE DAY OF THE LORD

1 THESSALONIANS 4:13-5:11

289. THE DAY OF THE LORD

(1 THESSALONIANS 4:13-5:11)



"For the Lord himself shall descend from heaven with a shout, with the voice of the archangel, and with the trump of God: and the dead in Christ shall rise first:"

1 THESSALONIANS 4:16

289. THE DAY OF THE LORD

(1 THESSALONIANS 4:13-5:11)

MEMORY VERSE:

"Let us who are of the day be sober, putting on the breastplate of faith and love, and as a helmet the hope of salvation." 1 THESSALONIANS 5:8

TRUE OR FALSE:

1. "For the Lord Himself will descend with a shout, with the voice of an archangel, and with the trumpet of God..." **1 THESSALONIANS 4:16**

TRUE OR FALSE

2. "...And the dead in Christ will rise first." **1 THESSALONIANS 4:16**

TRUE OR FALSE

CIRCLE THE CORRECT WORDS:

3. "Then we who are alive and remain shall be caught up together with them in the (MOUNTAINS, CLOUDS) to meet the Lord in the air..." **1 THESSALONIANS 4:17**

4. "...And thus we shall (SOMETIMES, ALWAYS) be with the Lord." **1 THESSALONIANS 4:17**

5. "For you yourselves know perfectly that the day of the Lord so comes as a (THIEF, MOON) in the night." **1 THESSALONIANS 5:2**

UNDERLINE THE CORRECT ANSWER:

6. "For when they say, 'Peace and safety!' then _____ comes upon them..."

1 THESSALONIANS 5:3

- a. peace and safety
b. sudden destruction

TRUE OR FALSE:

7. "Let us who are of the day be sober, putting on the breastplate of faith and love, and as a helmet the hope of salvation." **1 THESSALONIANS 5:8**

TRUE OR FALSE

8. "For God did not appoint us to wrath, but to obtain salvation through our Lord Jesus Christ."

1 THESSALONIANS 5:9

TRUE OR FALSE

289. THE DAY OF THE LORD

(1 THESSALONIANS 4:13-5:11)

J Z Y V Z H O B A T W N W B N
 T Z C C B Q I L G H Y S T N B
 H U T B O B W O D G D A H I I
 T H E S S A L O N I A N S M T
 U P G B Y K T E T N S G Z Q I
 O F U S B Q S J M E T U N F M
 H Q B B V I N L P H T W M U E
 S N B F T J O B U T W T B N S
 H B T H R G S N R N N R O Q B
 L Q G O U P A Z P I G O M G G
 Z C B C M C E Z T F F F C T A
 R J G G P Q S Q Y E L M A C H
 L R A S E I E B G I O O C A Q
 P I L M T Y H B O H B C R B Q
 J A L E D R I P D T R O B D Y

AIR
 ALWAYS
 COMFORT
 GOD
 LORD
 SEASONS

SHOUT
 THESSALONIANS
 THIEF IN THE NIGHT
 TIMES
 TRUMPET

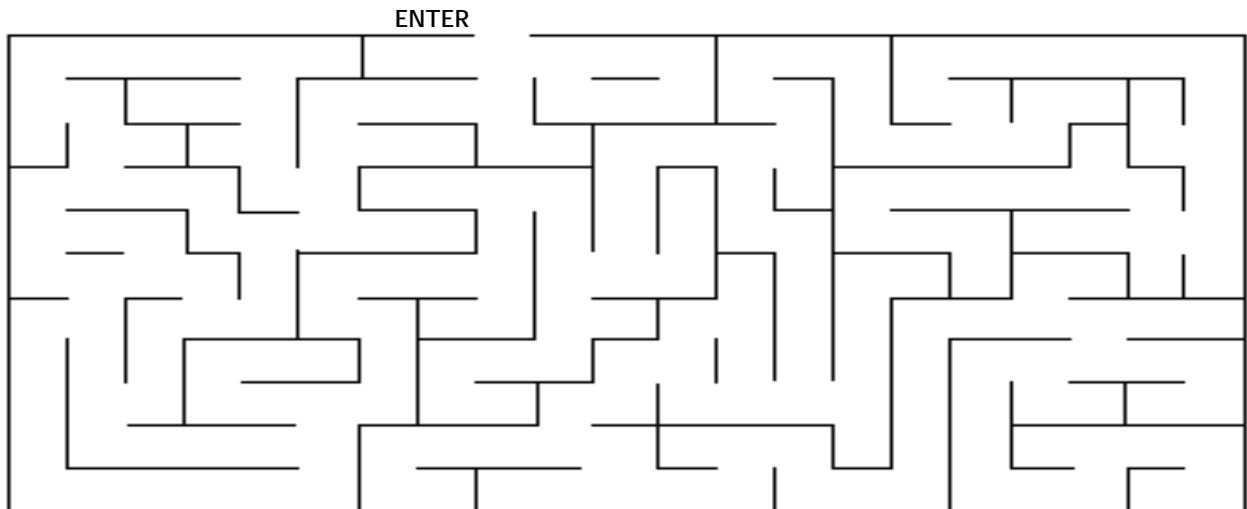

289. THE DAY OF THE LORD

(1 THESSALONIANS 4:13-5:11)

MEMORY VERSE:

"Let us who are of the day be sober, putting on the breastplate of faith and love, and as a helmet the hope of salvation." 1 THESSALONIANS 5:8

TRUE OR FALSE:

1. "For the Lord Himself will descend with a shout, with the voice of an archangel, and with the trumpet of God..." **1 THESSALONIANS 4:16**

TRUE OR FALSE

2. "...And the dead in Christ will rise first." **1 THESSALONIANS 4:16**

TRUE OR FALSE

FILL IN THE BLANKS:

3. "Then we who are alive and remain shall be caught up together with them in the _____ to meet the _____ in the air..." **1 THESSALONIANS 4:17**

4. "...And thus we shall _____ be with the Lord." **1 THESSALONIANS 4:17**

5. "For you yourselves know perfectly that the day of the Lord so comes as a _____ in the night." **1 THESSALONIANS 5:2**

UNDERLINE THE CORRECT ANSWER:

6. "For when they say, 'Peace and safety!' then _____ comes upon them..."

1 THESSALONIANS 5:3

- a. peace and safety
b. sudden destruction

TRUE OR FALSE:

7. "Let us who are of the day be sober, putting on the breastplate of faith and love, and as a helmet the hope of salvation." **1 THESSALONIANS 5:8**

TRUE OR FALSE

FILL IN THE BLANK:

8. "For God did not appoint us to wrath, but to obtain _____ through our Lord Jesus Christ." **1 THESSALONIANS 5:9**

289. THE DAY OF THE LORD

(1 THESSALONIANS 4:13-5:11)

A L O F K P E Y Y A V P R W Z E O V A Z A W A R Y N M G M J
 A J T T N S B N T H Q L O R D A T O W T L G E E B A L N Q K
 U F O S Y D A H X K G J Z A D F Y E N P K B N D Y B E W R Y
 F J G P J V S L K L Y R Q T T B H U U C Q Z Z U B U N O A T
 G B S G P W M N V T Q B Z H Q H F Z R W W P S L N V L P W S
 H P B L B E B N U A S Q L T J E S U S Y B Y K T J W A U W C
 K T H C R B Y B O Q T T C L T K E T R F S S U T S G P A B D
 Y C W G M I N V W E D I Z D A V E N L V N D A D F I J O O E
 B D C Q Y M H E H W O Q O Q Z A Z D A D A S V C I N R P W T
 G I B G D P Y K K Y C A N N D J N V T L I K B O S B P H O A
 G T Z E G N E C U O J C Q T Q F E O M F N H L D I D G W C R
 L O B T B U H W I I G H Y Z E O G A C C O Q C Q F Y S H E A
 L W G I I P V O G U N K F N M R Z T Q K L K O C O B R E P Y
 S R V Y P L A W U U E O B G P U B C B B A N I Z K N N E L B
 P I I D E C E Z D D D F W D Q B T W C E S N I A T B O Y Z T
 R E B D W T Y P P B J A K A F H B D H Y S Q D Y G Y V I B O
 B J C P G Z E B T R B O J F H F Z W J C E Q U W W N O G U G
 D I J S P Y K Q H E Q Q D J V Z T Z U N H L J J R I Q B G U
 Z Y N H G V T V S V E S Q I Z S J H A W T A I R D D R N S M
 K B Z J Q F H K A M Z U L L L E Q U K H K C S O M U H A G B
 G S K Z O C R L R G Z R C P K H S L A F F B V F B S R P D S
 Y P P U T F O B Y W J M R Q A Q T U Q L I D F V U O R N T F
 N K Z M H T U C L G R O V A K F B W Y E C H I W S Y B E L T
 T A N B P O G V V F U M L A C Q B U D O G B B R A M Y O W V
 Q M C I T N H R K R O L C I A Z R A Y L V L D P O J N E K C
 B R R M H T C C N M J F P B R N P Q B K S B J M Z O M O E W
 H A B N L O F B W J J S C T B R R C D Z A W P L U D J D H F
 J W C K D H R B F B B K K U O F K B S G Z T T B J E Z L B W
 A P P O I N T A I G D D N Q Y L F M C U E M G W Z C C B L Y
 B L Z L O N F F Z C B Y B E R C B Z P J D W B A G M O B S M

FIND ALL OF THE WORDS BELOW IN THE PUZZLE ABOVE

"For God did not appoint us to wrath, but to obtain salvation through our Lord Jesus Christ." 1 THESSALONIANS 5:9

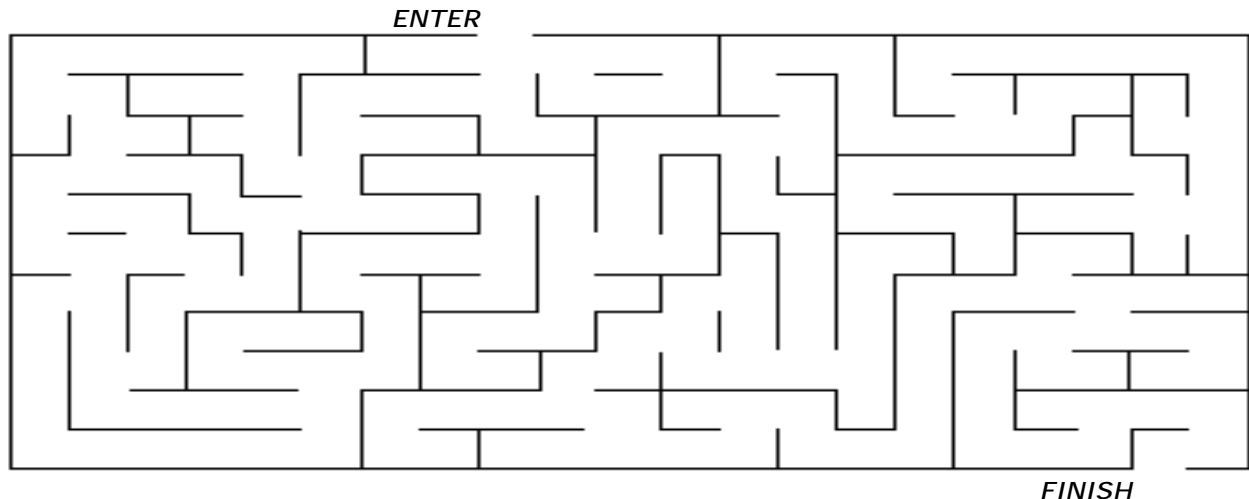

289. THE DAY OF THE LORD

(1 THESSALONIANS 4:13-5:11)

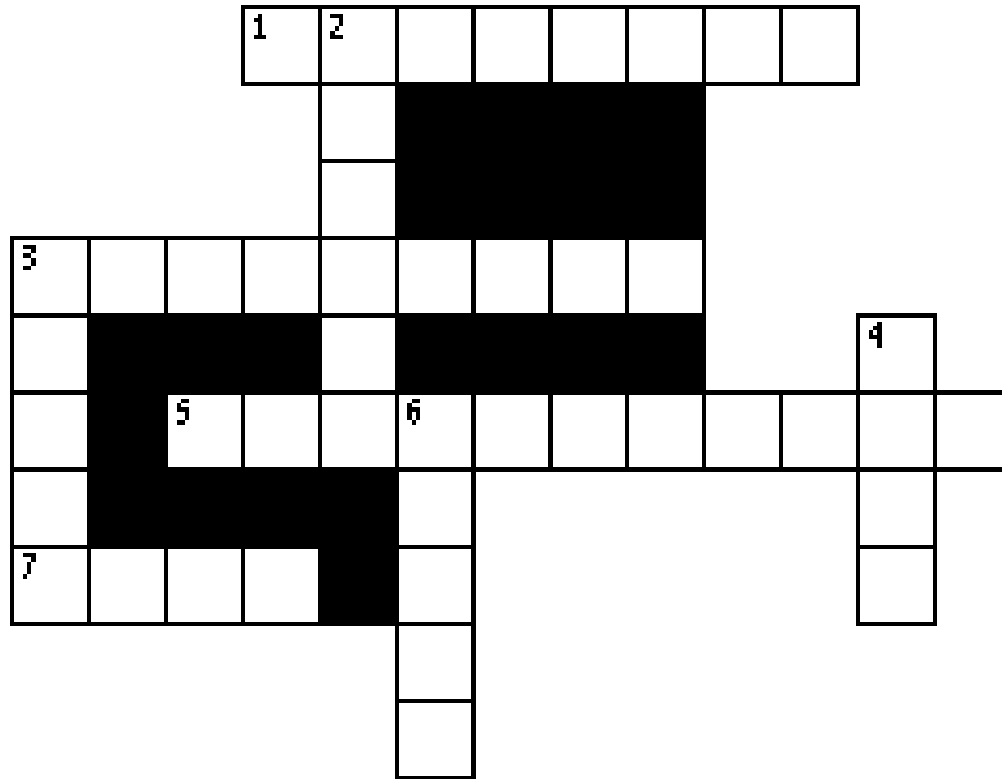

- 4 DOWN "For the _____ Himself will descend with a shout, with the voice of an archangel, and with the trumpet of God..." **1 THESSALONIANS 4:16**
- 7 ACROSS "...And the dead in Christ will _____ first." **1 THESSALONIANS 4:16**
- 1 ACROSS "Then we who are alive and remain shall be _____ together with them in the clouds to meet the Lord in the air..." **1 THESSALONIANS 4:17**
- 2 DOWN "...And thus we shall _____ be with the Lord." **1 THESSALONIANS 4:17**
- 6 DOWN "For you yourselves know perfectly that the day of the Lord so comes as a _____ in the night." **1 THESSALONIANS 5:2**
- 5 ACROSS "For when they say, 'Peace and safety!' then sudden _____ comes upon them..." **1 THESSALONIANS 5:3**
- 3 DOWN "Let us who are of the day be _____, putting on the breastplate of faith and love, and as a helmet the hope of salvation." **1 THESSALONIANS 5:8**
- 3 ACROSS "For God did not appoint us to wrath, but to obtain _____ through our Lord Jesus Christ." **1 THESSALONIANS 5:9**

Bible Story 290

**PRAY
FOR ALL MEN**

1 TIMOTHY 2:1-7



"PRAY FOR
ALL MEN..!"

1 Timothy 2:1

290. PRAY FOR ALL MEN

(1 TIMOTHY 2:1-7)

MEMORY VERSE:

"Therefore I exhort first of all that supplications, prayers, intercessions, and giving of thanks be made for all men." 1 TIMOTHY 2:1

CIRCLE THE CORRECT WORD:

1. "Therefore I exhort first of all that supplications, prayers, intercessions, and giving of thanks be made for **(ALL, SOME)** men, for kings and all who are in authority, that we may lead a quiet and peaceable life in all godliness and reverence." **1 TIMOTHY 2:1-2**

TRUE OR FALSE:

2. "For this is good and acceptable in the sight of God our Savior." **1 TIMOTHY 2:3**
TRUE OR FALSE
3. "...who desires all men to be saved and to come to the knowledge of the truth."
1 TIMOTHY 2:4
TRUE OR FALSE

FILL IN THE BLANKS:

4. "For there is one God and one Mediator between God and men, the Man _____
_____." **1 TIMOTHY 2:5**

CIRCLE THE CORRECT WORD:

5. "...who gave Himself a **(RANSOM, PRESENT)** for all, to be testified in due time."
1 TIMOTHY 2:6

TRUE OR FALSE:

6. "...for which I was appointed a preacher and an apostle- I am speaking the truth in Christ and not lying- a teacher of the Gentiles in faith and truth." **1 TIMOTHY 2:7**
TRUE OR FALSE

290. PRAY FOR ALL MEN

(1 TIMOTHY 2:1-7)

T B S A V E D K O V G L V G R
R I B U L L W E V N Q R I O G
U B N F P A B O M E O V I O E
T U D T G P V J L V I V O V I
H L O H E G L B G N A D G T P
C Y F L S R A I G S T Q R L L
V L B D Z T C O C M F B K C E
G H Q I P H F E D A H A Z M P
G O D E R T B S S U T R I G K
W B C P H G H Z O S K I L T S
H C R A O N C N T O I H O K H
A B N S R E Y A R P W O B N N
H K B M J W O W C B W N N M S
S B D W L B Y I U M B N I S U
B C H R I S T J E S U S V P W

ACCEPTABLE
CHRIST JESUS
FAITH
GIVING OF THANKS

GOD
GOOD
INTERCESSIONS
PRAYERS

SAVED
SAVIOR
SUPPLICATIONS
TRUTH



290. PRAY FOR ALL MEN

(1 TIMOTHY 2:1-7)

MEMORY VERSE:

"Therefore I exhort first of all that supplications, prayers, intercessions, and giving of thanks be made for all men." 1 TIMOTHY 2:1

FILL IN THE BLANK:

1. "Therefore I exhort first of all that supplications, prayers, intercessions, and giving of thanks be made for _____ men, for kings and all who are in authority, that we may lead a quiet and peaceable life in all godliness and reverence." **1 TIMOTHY 2:1-2**

TRUE OR FALSE:

2. "For this is good and acceptable in the sight of God our Savior." **1 TIMOTHY 2:3**
TRUE OR FALSE
3. "...who desires all men to be saved and to come to the knowledge of the truth."
1 TIMOTHY 2:4
TRUE OR FALSE

FILL IN THE BLANKS:

4. "For there is one God and one Mediator between God and men, the Man _____
_____." **1 TIMOTHY 2:5**
5. "...who gave Himself a _____ for all, to be testified in due time." **1 TIMOTHY 2:6**

TRUE OR FALSE:

6. "...for which I was appointed a preacher and an apostle- I am speaking the truth in Christ and not lying- a teacher of the Gentiles in faith and truth." **1 TIMOTHY 2:7**
TRUE OR FALSE

290. PRAY FOR ALL MEN

(1 TIMOTHY 2:1-7)

U U O N S T B Z G Z B Z K R R E I G E K Y H T O M I T D S E
 S C F B Z E T T Q B F Z K F E Z N C U B T Z C M E I T Q O M
 F L N K D G D G E G M Y K P B G E P O R B B P Q B K Z V H O
 T L C S P H S W H T Y D D F J U L M C V M K G H H A D W F U
 G T N F B K R C J H T T A I E L T K M Q Q R R B O M N Q M T
 I Z Y E L M H B Y A I H S B D H K W U N D F T Q R E G D G S
 M M G I M Z N B Z B Z V N N H L E G R V I M K Y T E Z T V R
 O O T V P G G N W R Z U T R O L U D P K M F P K Y A S H J I
 A Q Q H G K H I F N Q V P Q F I F O A K O Y Q J M L Q M O F
 E U I N E P T O C F P W M S E D T Z F M L V E K L P W J Q U
 V W I F Q U I J J J Z Q S Y I A E A Z O M N L R P U B D E G
 T J Q P T J H Q P H Z J S A Y I C F C M U S M L P G W S J U
 O A E F R B O G M A L R S L Z K G B F I T H H V A G J V B R
 Z Y P B E D R O F Z Q H R E M S F M Z Q L Q B O B G T H Z Z
 N V K W O D S Y T R Q Q T Y D B H Z T W R Q P W K M Q K S J F
 I U U I B J T L P G C K C E R H G J B E A O P J V Y I B B Z
 J Q S P R R H N Q I E L Q G T F V M V R H P H U U I C P M F
 E N O A B Z A F R J O M Q H Q G C R E I Q S O N S H U I Q C
 W I F M B C N G K O C I E Z F W I D R A R E A V J M D I J R
 F H K J K Q K Z I R N R F R S B E V Z S N A I K B S B V W Q
 V D V W C M S L D R E G I T U I P C I A T D S T J S C Z A W
 P I I E C I R S Z F S R L Q G H U E J N E S R W R E C V J L
 N T T T A T A E O F C W A W Y B M W D S G T D E A K B B A B
 B F J R Y P H R Y T E V P L L E Z Q K P E H Y T B J B E M R
 O H W K E O E A J P B N U F L A T Q B L B A K T Q M T T H D
 I E G B O U H J T V B B E L Z R R M G B R A K I Q P M R Z J
 B M W Q R Q Y E M R W O D M L Z G B R P G I D U F Z P L S W
 Z B U Q Q L H C Y W Z H S T M S N O I S S E C R E T N I A E
 U L E A R J B B C A M T W I Y W M E B Y N I S R Y E D E Y I
 U Z U T B N S W R Z N P G C N C Y W W B T E Z I Y S P G O G

FIND ALL OF THE WORDS BELOW IN THE PUZZLE ABOVE

*"Therefore I exhort first of all that supplications, prayers, intercessions,
and giving of thanks be made for all men." 1 TIMOTHY 2:1*



290. PRAY FOR ALL MEN

(1 TIMOTHY 2:1-7)

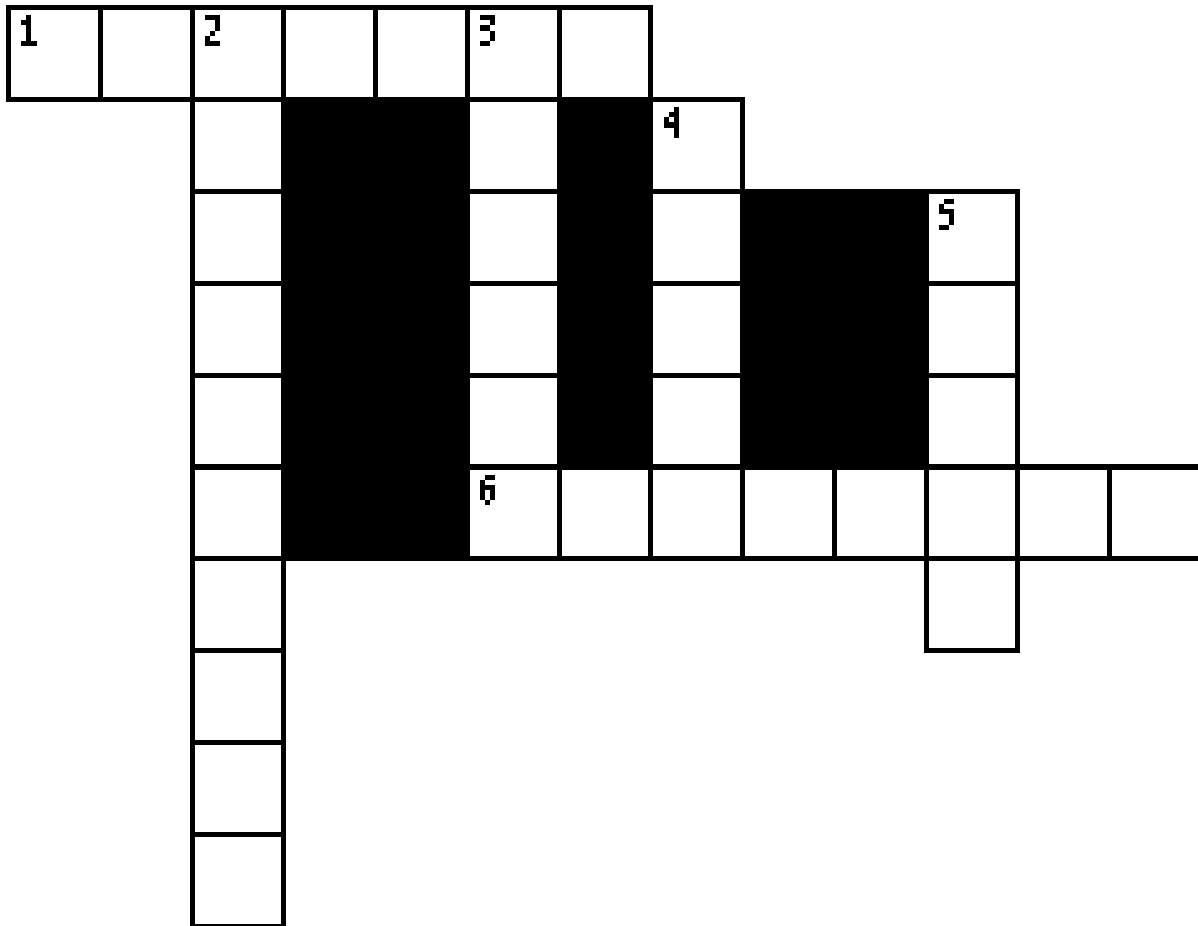

- 1 ACROSS "Therefore I exhort first of all that supplications, _____, intercessions, and giving of thanks be made for **(ALL, SOME)** men, for kings and all who are in authority, that we may lead a quiet and peaceable life in all godliness and reverence." **1 TIMOTHY 2:1-2**

- 2 DOWN "For this is good and _____ in the sight of God our Savior." **1 TIMOTHY 2:3**

- 4 DOWN "...who desires all men to be _____ and to come to the knowledge of the truth." **1 TIMOTHY 2:4**

- 6 ACROSS "For there is one God and one _____ between God and men, the Man Christ Jesus." **1 TIMOTHY 2:5**

- 3 DOWN "...who gave Himself a _____ for all, to be testified in due time." **1 TIMOTHY 2:6**

- 5 DOWN "...for which I was appointed a preacher and an apostle- I am speaking the _____ in Christ and not lying- a teacher of the Gentiles in faith and truth." **1 TIMOTHY 2:7**

Bible Story 291

THE LAST DAYS

2 TIMOTHY 3:1-9

291. THE LAST DAYS

(2 TIMOTHY 3:1-9)



"This know also, that in the last days perilous times shall come. For men shall be lovers of their own selves, covetous, boasters, proud, blasphemers, disobedient to parents, unthankful, unholy,..."

2 TIMOTHY 3:1-2

291. THE LAST DAYS

(2 TIMOTHY 3:1-9)

MEMORY VERSE:

"But know this, that in the last days perilous days will come." 2 TIMOTHY 3:1

CIRCLE THE CORRECT WORD:

1. "But know this, that in the last days (**SAFE, PERILOUS**) times will come." 2 TIMOTHY 3:1

TRUE OR FALSE:

- | 2. "For men will be..." 2 TIMOTHY 3:2-4 | T OR F |
|--|--------|
| * lovers of themselves | _____ |
| * lovers of money | _____ |
| * boasters | _____ |
| * not proud | _____ |
| * blasphemers | _____ |
| * disobedient to parents | _____ |
| * thankful | _____ |
| * unholy | _____ |
| * loving | _____ |
| * unforgiving | _____ |
| * slanderers | _____ |
| * without self-control | _____ |
| * brutal | _____ |
| * despisers of good | _____ |
| * traitors | _____ |
| * headstrong | _____ |
| * haughty | _____ |
| * lovers of pleasure rather than lovers of God | _____ |

CIRCLE THE CORRECT WORD:

3. "...having a form of godliness but denying its power. And from such people turn (**AWAY, TOWARDS**)!" 2 TIMOTHY 3:5

291. THE LAST DAYS

(2 TIMOTHY 3:1-9)

K U G N I V I G R O F N U D S
 U N T H A N K F U L A H S L B
 E L W S C F P A B A E E A T O
 N O R Q D A E G H J V N R W A
 C V T U U B U K Z L D A H S S
 H I N R O E R S E E I P E L T
 A N E G R G B S R T L N A A E
 U G I L P G M E O L B T D T R
 G T D Y W E R R J T D Y S U S
 H M E F H S S U L U M L T R T
 T O B T A H M L L N M C R B I
 Y N O B V B K M B H M O O A B
 B E S O W Y N O Y O B Y N B A
 C Y I W B B B T C L O Y G T C
 C B D B P A H J Z Y R C Y Q D

"But know this, that in the last days perilous times will come: For men will be..."

FIND THESE WORDS:

- | | | |
|-------------|------------------------|-------------|
| BOASTERS | (LOVERS OF) MONEY | UNFORGIVING |
| BRUTAL | PROUD | UNHOLY |
| DISOBEDIENT | SLANDERERS | UNLOVING |
| HAUGHTY | (LOVERS OF) THEMSELVES | UNTHANKFUL |
| HEADSTRONG | TRAITORS | |

...having a form of godliness but denying its power. And from such people turn away!"

2 TIMOTHY 3:1-5

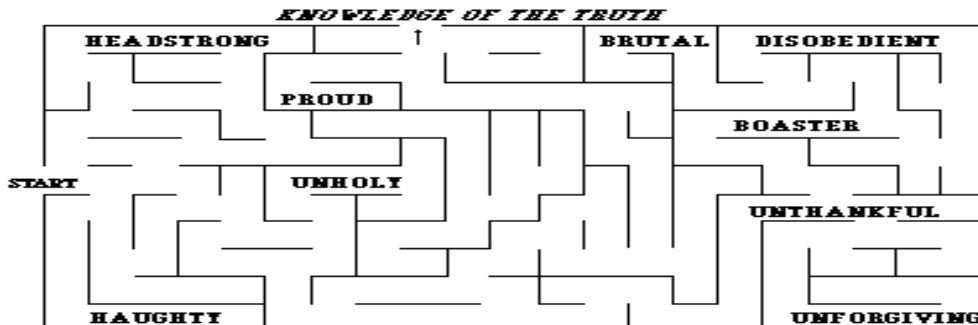

291. THE LAST DAYS

(2 TIMOTHY 3:1-9)

MEMORY VERSE:

"But know this, that in the last days perilous days will come." 2 TIMOTHY 3:1

FILL IN THE BLANK:

1. "But know this, that in the last days _____ times will come." 2 TIMOTHY 3:1

TRUE OR FALSE:

- | 2. "For men will be..." 2 TIMOTHY 3:2-4 | T OR F |
|--|--------|
| * lovers of themselves | _____ |
| * lovers of money | _____ |
| * boasters | _____ |
| * not proud | _____ |
| * blasphemers | _____ |
| * disobedient to parents | _____ |
| * thankful | _____ |
| * unholy | _____ |
| * loving | _____ |
| * unforgiving | _____ |
| * slanderers | _____ |
| * without self-control | _____ |
| * brutal | _____ |
| * despisers of good | _____ |
| * traitors | _____ |
| * headstrong | _____ |
| * haughty | _____ |
| * lovers of pleasure rather than lovers of God | _____ |

FILL IN THE BLANKS:

3. "...having a form of godliness but denying its power. And from such people _____
_____!" 2 TIMOTHY 3:5

291. THE LAST DAYS

(2 TIMOTHY 3:1-9)

D Z H G Q N G B Y P U R B M B J S B S Q O S C F S O R D N P
 Q T H B B Z F B C M B I A U T R H B O S I I N L D G D L Q V
 A U L G K Z O N L B U V K G O S E R M E P S S S M T E C D B
 F J Z A Q Q B I V U G K E T Y J A J L V M J P W V V S L C B
 S Q R L I B R M X F O T I S U E D A W L P M C U C A S K U R
 R K L L J B N Q O S B A N Q K F S H R E S S K B U M B A A C
 E K P V G P S F B U R R Y P I H T B J S S L P B M A R D E R
 R V J C P G A U I T N A I H G B R Z W M N W T B J H J P I L
 E H Z B C D G N B Y T L Y B R M O H H E Z G G O W L F R H B
 D S Z U N F O R G I V I N G E H N P J H Y F S V W E H H T R
 N T U B Q T U L B P D J Q B Y T G Y F T M M P B O U P Q J Q
 A O P B D M W Q O B L K S Q K D B J J F R L B Z S R M B B Z
 L L F U I D O G A V U A W T C L J U Q O Y C K O Z U O B K B
 S S O F L P I T S K E N T Y D T L G L S F B K A S A S N K P
 A R Q H Y U W S M S H R L U Y Q Q P L R Q P V R S W G N P T
 P T N O R U F C O U Y S S O R E N C B E D F M T U G J B E U
 H Y L O H N U K U B J V U O V B N M R V W T E Y D N N A I P
 D R B C O R T A N I E H K O F I M O Y O M R T B C H U Q G G
 W B Q G I P H B Z A T D T E O P N K M L S V P V Q E O H T B
 Y Z C S T T Z N O I H W I B B F L G M F G R Z R Q H F C G J
 F U J M E Y N B B Y G T P E F R P E Q J O K K L H P O G M B
 Z O Y E H W M I H U P S N Q N D T J A U R S R N B Q L I Y T
 W S R E M E H P S A L B E U K T G P U S L S R Q S F V I B B
 G W C Z I Y B B W W M G B P Q H C F U V U J O E B M C J O B
 Z E T B B D D E S P I S E R S O F G O O D R Y M V G P P Q K
 T C G O O S O G C Y R T O W U K U G M R R D E V F O F B Z S
 T U U B E T M A E F Y B G Q S P A R R F Y D D S O G L Z H S
 J C B V J T C H R Y L U K B R P Q N I J M D U C Z D T F N O
 G J B D L W A Q Z O E C D O T P O C C S P W P L F C I U I D
 A T T H B N C Q B S H G N G F R A D B A N Y T H G U A H W U

"But know this, that in the last days perilous times will come: For men will be..."

FIND THESE WORDS:

- | | | |
|-------------|------------------------|-------------|
| BOASTERS | (LOVERS OF) MONEY | UNFORGIVING |
| BRUTAL | PROUD | UNHOLY |
| DISOBEDIENT | SLANDERERS | UNLOVING |
| HAUGHTY | (LOVERS OF) THEMSELVES | UNTHANKFUL |
| HEADSTRONG | TRAITORS | |

...having a form of godliness but denying its power. And from such people turn away!"

2 TIMOTHY 3:1-5

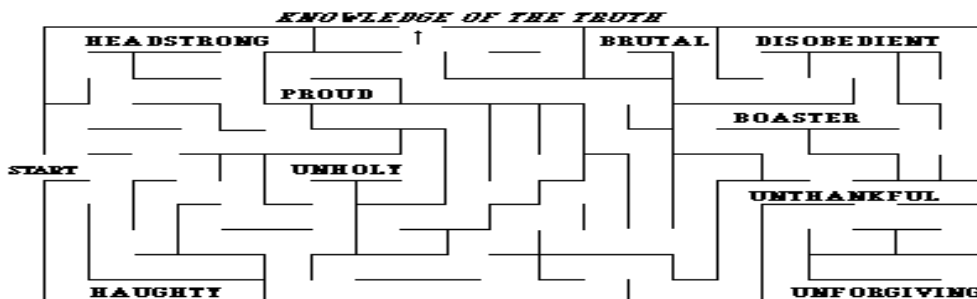

291. THE LAST DAYS

(2 TIMOTHY 3:1-9)

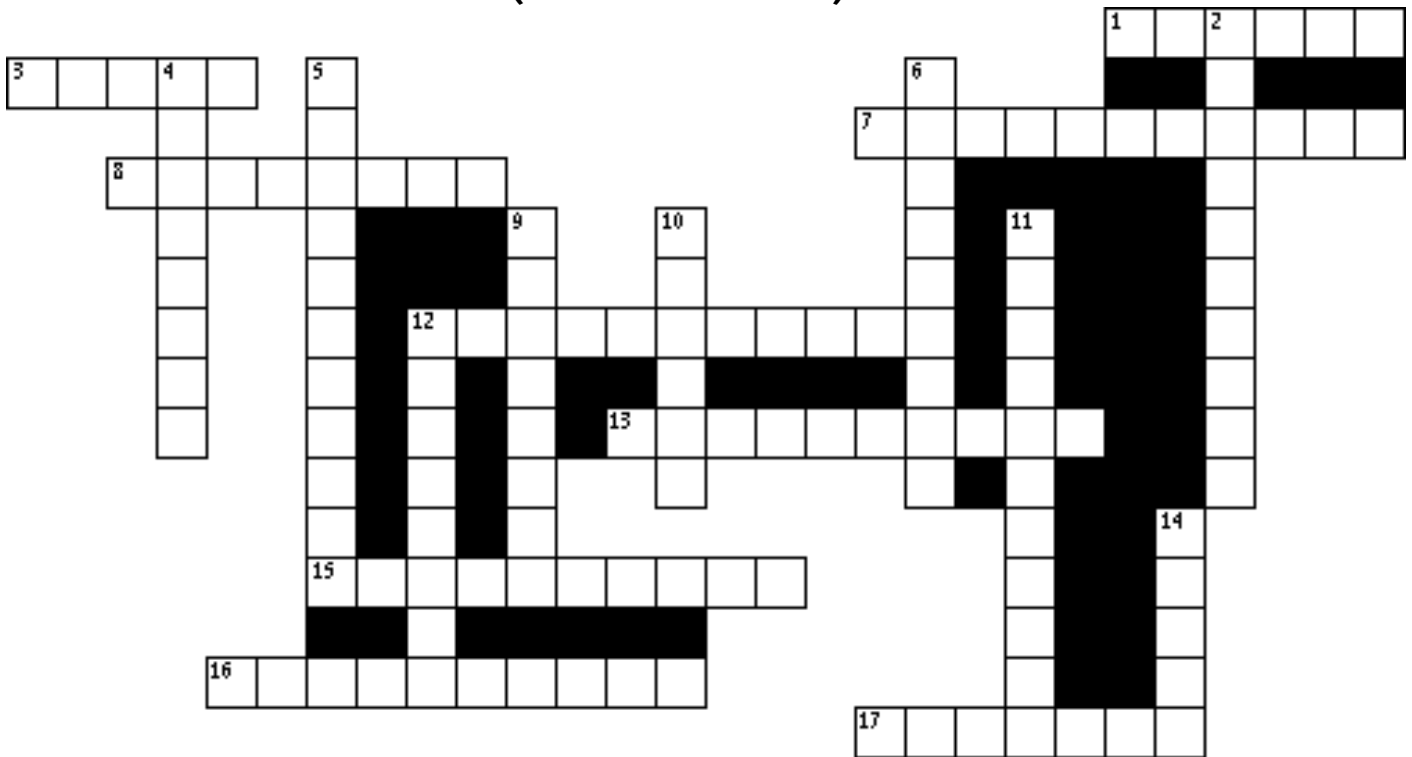

"But know this, that in the last days perilous times will come." 2 TIMOTHY 3:1

"For men will be..." 2 TIMOTHY 3:2-4

15 ACROSS lovers of _____ 2 TIMOTHY 3:2

14 DOWN lovers of _____ 2 TIMOTHY 3:2

12 DOWN _____ 2 TIMOTHY 3:2

3 ACROSS _____ 2 TIMOTHY 3:2

12 ACROSS _____ 2 TIMOTHY 3:2

5 DOWN _____ to parents 2 TIMOTHY 3:2

2 DOWN _____ 2 TIMOTHY 3:2

10 DOWN _____ 2 TIMOTHY 3:2

4 DOWN _____ 2 TIMOTHY 3:3

11 DOWN _____ 2 TIMOTHY 3:3

13 ACROSS _____ 2 TIMOTHY 3:3

7 ACROSS without _____ 2 TIMOTHY 3:3

1 ACROSS _____ 2 TIMOTHY 3:3

6 DOWN _____ of good 2 TIMOTHY 3:3

9 DOWN _____ 2 TIMOTHY 3:4

16 ACROSS _____ 2 TIMOTHY 3:4

17 ACROSS _____ 2 TIMOTHY 3:4

8 ACROSS lovers of _____ rather than lovers of God. 2 TIMOTHY 3:4

"...having a form of godliness but denying its power. And from such people turn away!" 2 TIMOTHY 3:5

Bible Story 292

**DEMAS
FORSAKES
PAUL**

2 TIMOTHY 4:9-21

292. DEMAS FORSAKES PAUL
(2 TIMOTHY 4:9-21)



"Notwithstanding the Lord stood with me, and strengthened me; that by me the preaching might be fully known, and *that* all the Gentiles might hear: and I was delivered out of the mouth of the lion."

2 TIMOTHY 4:17

292. DEMAS FORSAKES PAUL

(2 TIMOTHY 4:9-21)

MEMORY VERSE:

"And the Lord will deliver me from every evil work and preserve me for His heavenly kingdom."
2 TIMOTHY 4:18

Paul writes to Timothy...

CIRCLE THE CORRECT WORD:

1. "Be diligent to come to me quickly; for (**DEMAS, GOD**) has forsaken me, having loved this present world..."
2 TIMOTHY 4:9-10

CIRCLE T FOR TRUE AND F FOR FALSE:

2 TIMOTHY 4:11-13

2. a. Only Luke is with me..." (v11) T F
b. ...Leave Mark behind because he is not useful for ministry (v11) T F
c. And Tychicus I have sent to Ephesus." (v12) T F
d. Bring the cloak that I left with Carpus at Troas when you come-
and the books, especially the parchments." (v13) T F

CIRCLE THE CORRECT WORD:

3. "Alexander the (**TENTMAKER, COPPERSMITH**) did me much harm. May the Lord repay him according to his works." 2 TIMOTHY 4:14

TRUE OR FALSE:

4. "At my first defense no one stood with me, but all forsook me. May it not be charged against them."
2 TIMOTHY 4:16

TRUE OR FALSE

5. "But the Lord stood with me and strengthened me, so that the message might be preached fully through me, and that all the Gentiles might hear..." 2 TIMOTHY 4:17

TRUE OR FALSE

CIRCLE THE CORRECT WORDS:

6. "...And I was delivered out of the mouth of the (**GREAT FISH, LION**)."
2 TIMOTHY 4:17
7. "And the Lord (**WILL, WILL NOT**) deliver me from every evil work and preserve me for His heavenly kingdom."
2 TIMOTHY 4:18

292. DEMAS FORSAKES PAUL

(2 TIMOTHY 4:9-21)

F O S P Z Y G O P M R C I A T
O F V J W P N F G D C W T H D
R V O H B Y G L K L M J E Y R
S B J G M B L U F E S U J L O
A S Y R T S I N I M L U K K L
K V J E W D Z L B L I O N C P
E M E U U R J M U S B K K I L
N A A W F C P L U A P O P U J
A D E N E H T G N E R T S Q C
Y Z W D I S A M E D B R Z A V
K S K A O L C S K V A E Y H R
R H L W B G N Z C E C T Y Z E
A L E X A N D E R K O N O Y P
M M Z Y G R U F U U M I J N A
Y B B P S K R O W L E W F J Y

ALEXANDER

LORD

REPAY

CLOAK

LUKE

STRENGTHENED

COME

MARK

USEFUL

DEMAS

MINISTRY

WINTER

FORSAKEN

PAUL

WORKS

LION

QUICKLY

292. DEMAS FORSAKES PAUL

(2 TIMOTHY 4:9-21)

MEMORY VERSE:

"And the Lord will deliver me from every evil work and preserve me for His heavenly kingdom."
2 TIMOTHY 4:18

Paul writes to Timothy...

FILL IN THE BLANK:

1. "Be diligent to come to me quickly; for _____ has forsaken me, having loved this present world..."
2 TIMOTHY 4:9-10

CIRCLE T FOR TRUE AND F FOR FALSE:

2 TIMOTHY 4:11-13

- | | | | |
|----|--|---|---|
| 2. | a. Only Luke is with me..." (v11) | T | F |
| | b. ...Leave Mark behind because he is not useful for ministry (v11) | T | F |
| | c. And Tychicus I have sent to Ephesus." (v12) | T | F |
| | d. Bring the cloak that I left with Carpus at Troas when you come-
and the books, especially the parchments." (v13) | T | F |

FILL IN THE BLANK:

3. "Alexander the coppersmith did me much _____. May the Lord repay him according to his works."
2 TIMOTHY 4:14

TRUE OR FALSE:

4. "At my first defense no one stood with me, but all forsook me. May it not be charged against them."
2 TIMOTHY 4:16

TRUE OR FALSE

5. "But the Lord stood with me and strengthened me, so that the message might be preached fully through me, and that all the Gentiles might hear..." 2 TIMOTHY 4:17

TRUE OR FALSE

FILL IN THE BLANKS:

6. "...And I was delivered out of the mouth of the _____." 2 TIMOTHY 4:17

7. "And the Lord will _____ me from every evil work and preserve me for His heavenly kingdom."
2 TIMOTHY 4:18

292. DEMAS FORSAKES PAUL

(2 TIMOTHY 4:9-21)

H U S D I P F I T F P Y K O T M P C V F S M P Y I
K L U A P J L W I V J B B I P F E N D K C L O A K
N H I R P T U Z O B H D U T L Q V Q Q D M C C R J
C E L E H B F K T S G R K E C T U L E B C C D G J
U R S U Z I E K A V E C C J O S N I N K Z V T I Y
Q J J W I A S Q N M U G U K M W A E C W I N T E R
D W F J V M U J R A W R M N E U R K G K L Z B K T
C S O N E K A S R O F G D K O D L D R I L K B U H
N T F R V B H B P Z D N L P J I W D Y Y L Y G A G
W A O N K T A B I S W G S Z C S L O Y K A I E V F
T Z P S B S W R Q H Y Z V Y V J S A M E D P D B Y
M S E Z Q Y B B D M P J S Y T D J K D A U F E O Q
A D O K Y L P K J B Z P R T R H U Q J T T K I R D
R J O B E I E E Q B W N C O R Q O K I W M S K U C
K Q R E D N A X E L A U L O W E E L P L O M B V M
I I C Z L O B F R V B O M J H O N W T A E O P Z P
W K F F N V G J I O M F L F P E P G V P M A P A O
P T K H V Q D T L J W L B A J W T K T P B T U U E
P D B N Q Z E E S J U L B H H E C E R H N M Z E A
W Y Y G T U P J T E F M A A Q B K I F A E Z V F Y
M I N I S T R Y F A I S C H O U S J E B O N F P U
Q H N B A A Z Z A W B Z W Z L K C S J V B J E T H
T U M G Q N C Z Y L G F J Y A S H U O Q U S R D A
A Q H R F M C K Y Z Y P U N W U U E U D L M K O E
U S L Q H G Q C O B P G K J V H E A G V P B K N C

ALEXANDER

LION

QUICKLY

CLOAK

LORD

REPAY

COME

LUKE

STRENGTHENED

DEMAS

MARK

USEFUL

DILIGENT

MINISTRY

WINTER

FORSAKEN

PAUL

WORKS

292. DEMAS FORSAKES PAUL (2 TIMOTHY 4:9-21)

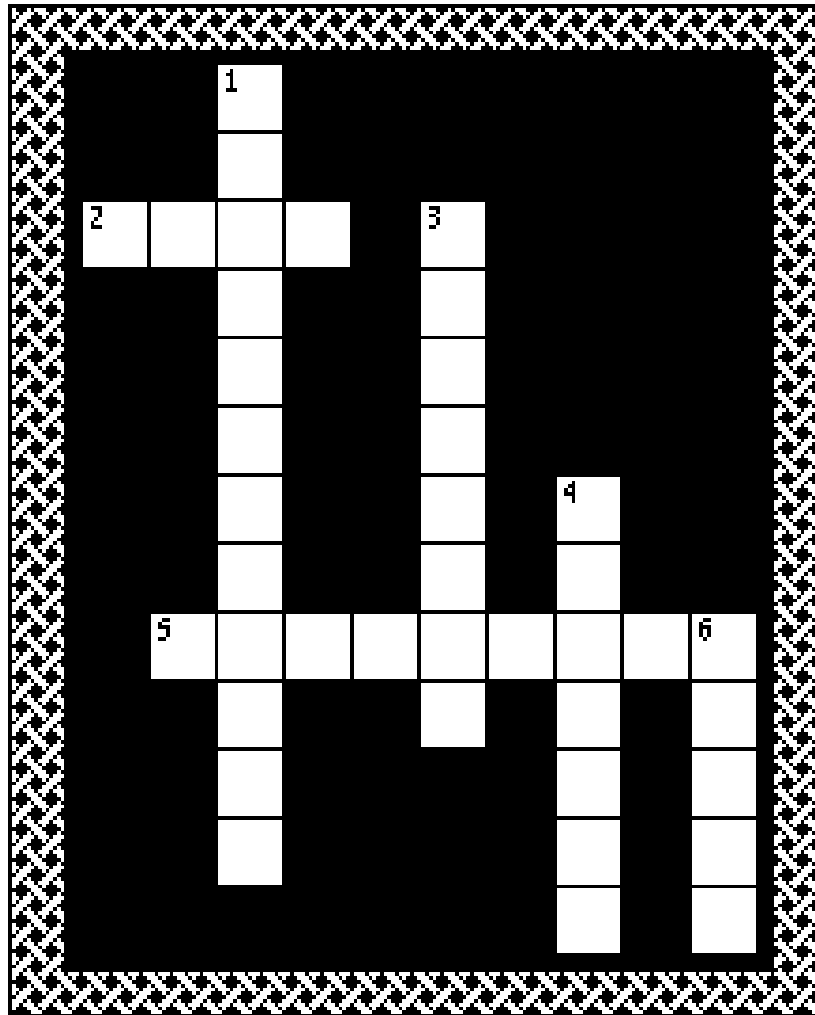

- 6 DOWN "Be diligent to come to me quickly; for _____ has forsaken me, having loved this present world..."
2 TIMOTHY 4:9-10
- 2 ACROSS "Alexander the coppersmith did me much _____. May the Lord repay him according to his works."
2 TIMOTHY 4:14
- 4 DOWN "At my first defense no one stood with me, but all _____ me. May it not be charged against them."
2 TIMOTHY 4:16
- 1 DOWN "But the Lord stood with me and _____ me, so that the message might be preached fully through me, and that all the Gentiles might hear..." **2 TIMOTHY 4:17**
- 5 ACROSS "...And I was _____ out of the mouth of the lion." **2 TIMOTHY 4:17**
- 3 DOWN "And the Lord will deliver me from every evil work and _____ me for His heavenly kingdom."
2 TIMOTHY 4:18

Bible Story 293

HEIRS OF GRACE

TITUS 3:3-8

293. HEIRS OF GRACE
(TITUS 3:1-8)



"That having been justified by His grace we should become heirs according to the hope of eternal life."

TITUS 3:7

293. HEIRS OF GRACE

(TITUS 3:1-8)

MEMORY VERSE:

"That having been justified by His grace we should become heirs according to the hope of eternal life." TITUS 3:7

Paul wrote...

TRUE OR FALSE:

1. "...speak evil of no one, to be peaceable, gentle, showing all humility to all men." **TITUS 3:2**
TRUE OR FALSE

CIRCLE THE CORRECT WORD:

2. "But when the kindness and the love of God our Savior toward man appeared, not by works of righteousness which we have done, but according to His mercy, He (**SAVED, FORSOOK**) us..." **TITUS 3:4-5**

TRUE OR FALSE:

3. "...He saved us, through the washing of regeneration and renewing of the Holy Spirit."
TITUS 3:5
TRUE OR FALSE

CIRCLE THE CORRECT WORD:

4. "That having been justified by His (**LAW, GRACE**) we should become heirs according to the hope of eternal life." **TITUS 3:7**

TRUE OR FALSE:

5. This is a faithful saying, and these things I want you to affirm constantly, that those who have believed in God need not be careful to maintain good works... **TITUS 3:8**
TRUE OR FALSE

6. "...These things are good and profitable to men." **TITUS 3:8**
TRUE OR FALSE

293. HEIRS OF GRACE

(TITUS 3:1-8)

K O H Z B J A Q Y S O H U I R
 I V A C B Z N R O H J G W B C
 N Q W C R Z R I F M J E D E G
 D Z B Q B K E C A R G S W L R
 N U Y T I L I M U H E A Y T G
 E D P I K C P L V B A V P N N
 S O E W E T I S B S W I Z E G
 S G S Z F I Q T S V L O W G Z
 M T I R I P S Y L O H R B G J
 B A G B J S R I E H Z Y M Y P
 T N S U S E J F V O B C W P S
 Y M D B T O D A M E B R U Y A
 P E A C E A B L E P P E F B V
 L G E Q E T J Y A O J M Y D E
 I F P J E F I L Z H L O V E D

GENTLE
 GOD
 GRACE
 HEIRS
 HOLY SPIRIT
 HOPE

HUMILITY
 JESUS
 KINDNESS
 LIFE
 LOVE

MERCY
 OBEY
 PEACEABLE
 SAVED
 SAVIOR

ENTER

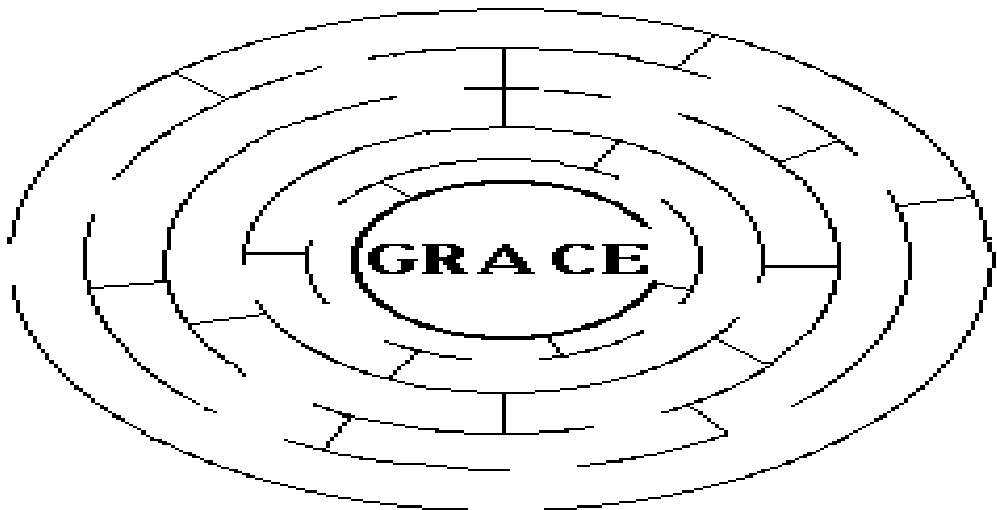

293. HEIRS OF GRACE

(TITUS 3:1-8)

MEMORY VERSE:

"That having been justified by His grace we should become heirs according to the hope of eternal life." TITUS 3:7

Paul wrote...

TRUE OR FALSE:

1. "...speak evil of no one, to be peaceable, gentle, showing all humility to all men." TITUS 3:2
TRUE OR FALSE

FILL IN THE BLANK:

2. "But when the kindness and the love of God our Savior toward man appeared, not by works of righteousness which we have done, but according to His mercy, He _____ us..."
TITUS 3:4-5

TRUE OR FALSE:

3. "...He saved us, through the washing of regeneration and renewing of the Holy Spirit."
TITUS 3:5
TRUE OR FALSE

FILL IN THE BLANKS:

4. "That having been justified by His _____ we should become _____ according to the hope of eternal life." TITUS 3:7

TRUE OR FALSE:

5. This is a faithful saying, and these things I want you to affirm constantly, that those who have believed in God need not be careful to maintain good works... TITUS 3:8
TRUE OR FALSE
6. "...These things are good and profitable to men." TITUS 3:8
TRUE OR FALSE

293. HEIRS OF GRACE

(TITUS 3:1-8)

I C T M W G U I L J E I E S S V I N U M C I D R J E P U A E
 O C S S E N D N I K P J M M M F J C D G D O V N I V F Y P O
 V Q A A D R K T J H T E J C O R J Z Y G Y W E V O L Q N B E
 Q I N Z W G C E C Q R S O Z A K Y H G R R A C L P U K M I N
 Z W R S Y N U J V C C U U L T K T A T E Q E U M K V G H C S
 U Z P H P G M K Y O S E G U M Y H T I H L P A A D P B B N M
 A K S P E A K K T E C A F T Z R G E I U T B U B A I Q Y Z J
 N K I M Z Z D P W W H V K M J G F F P V B Q A T Y R L A F D
 M H Q B T I R I P S Y L O H S I Y U G Y K T T E S F J O N H
 G Q U S W J L Z H E U D D O M K Q L C Y I F E O C V V M F R
 F J D M G P S Y P B E Q B E B U D B J R J V K N G A U B P T
 H B J V I E V Y J K C E K M P A C R N T E I O K M Q E H G K
 A B Q O B L N O H S N N K B C V M P H D E V I E C E D P G R
 S R R J M N I T Q S A R A N D A P J E E F F O V B B B N Z B
 U B I J W U R T L U Q V T O T B U P D U S R P E T I E B A W
 B K L E U O C J Y E L Y I B B O O T B S A N F F L P A V B U
 J E T S I R H C S U S E J O B U E Q H S G Y D G A O F I K E
 E F S A F F M F O H K Y W U R V A B Y O Q M H S B R I U O E
 C J T W I L L A Y V N E L L G Z Y Q K F R Z D L O A M S M O
 T T F L B L B H A P D D A P E A U F K J F I F C S B I S Y Z
 W E A Z G M B A W E D J P M I U H G J S H U T Y H A E A S N
 B J Y B Y S A H V V E I P C K R A A M G W I W I P V V Y G K
 P Z Y P P Z C Z M A O C A C E E E M V R H K Y D E K O E U K
 E Z O J Y F W Y F R K P I A B F C M W S U N S T U S Q L D J
 S D I S O B E D I E N T D L P P N A I A I M K L V R H Y I H
 G K F H B P J N S L Q Y B V A T A L Z S K C T E C A R G S R
 D C V G D G U J W W K T V Z P M O O F F E D E V L W U J C R
 E T B E R K K T U J L V Q K U O I K I N Y N F P R Y N H T I
 P I S S R I E H D U W R D F F O Z C Z T B Y G O D B H W E S
 Z O V U C B O P S O K F V K Z N S Y T Q T J Y T R G P Z K H

AUTHORITIES
 DECEIVED
 DISOBEDIENT
 ENVY
 FOOLISH
 GENTLE

GOD
 GRACE
 HATEFUL
 HEIRS
 HOLY SPIRIT
 HUMILITY

JESUS CHRIST
 KINDNESS
 LOVE
 MALICE
 MERCY
 OBEY

PEACEABLE
 READY
 SAVED
 SAVIOR
 SPEAK
 SUBJECT

ENTER

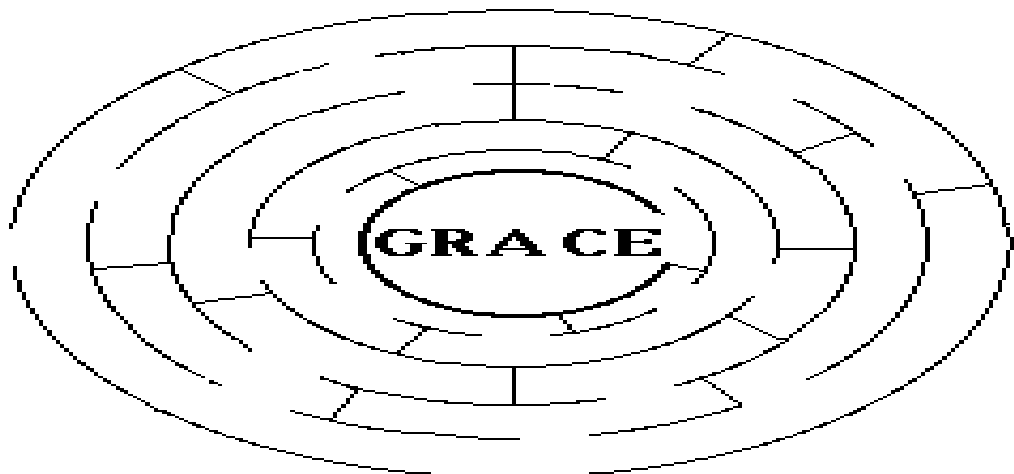

293. HEIRS OF GRACE

(TITUS 3:1-8)

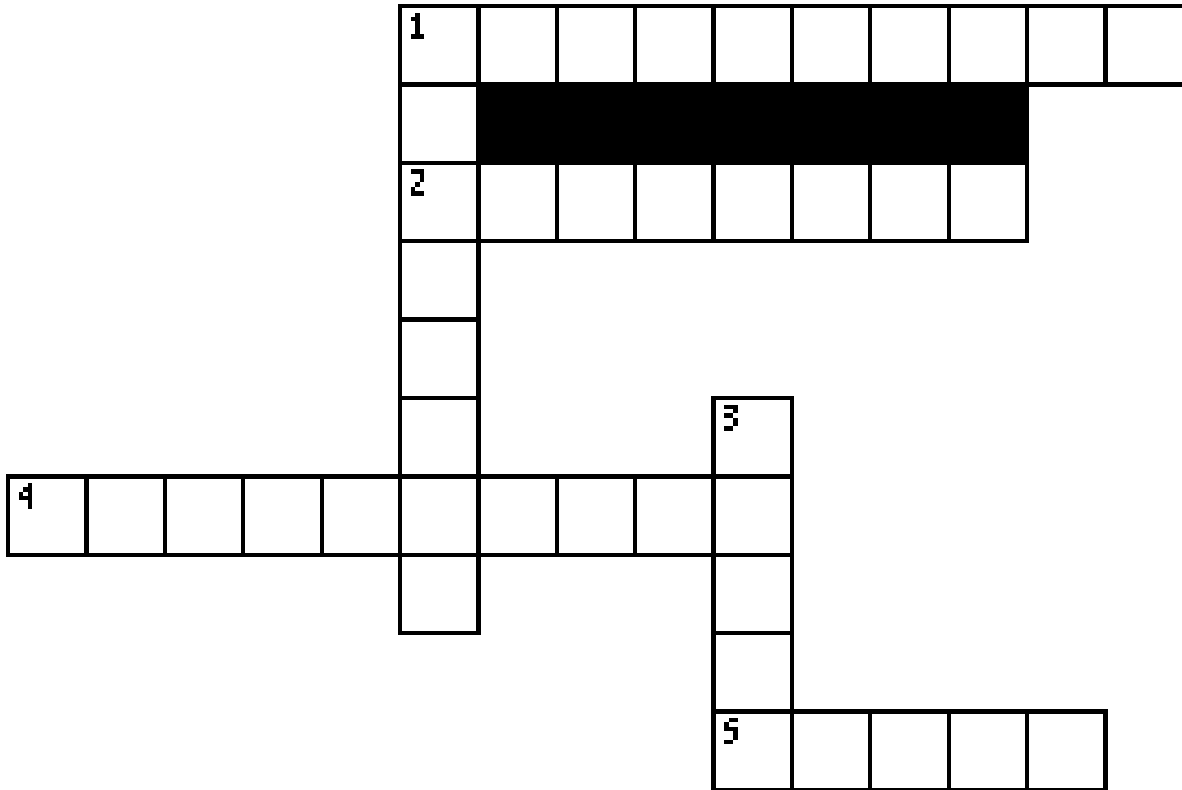

- 1 DOWN "...speak evil of no one, to be peaceable, gentle, showing all _____ to all men." **TITUS 3:2**
- 5 ACROSS "But when the kindness and the love of God our Savior toward man appeared, not by works of righteousness which we have done, but according to His mercy, He _____ us..." **TITUS 3:4-5**
- 1 ACROSS "...He saved us, through the washing of regeneration and renewing of the _____ _____." **TITUS 3:5**
- 3 DOWN "That having been justified by His grace we should become _____ according to the hope of eternal life." **TITUS 3:7**
- 2 ACROSS "This is a faithful saying, and these things I want you to affirm constantly, that those who have believed in God should be careful to _____ good works..." **TITUS 3:8**
- 4 ACROSS "...These things are good and _____ to men." **TITUS 3:8**

Bible Story 294

PAUL WRITES TO PHILEMON

PHILEMON 1:1-25

294. PAUL WRITES TO PHILEMON
(PHILEMON 1:1-25)



"Yes, brother, let me have joy from you in the Lord; refresh my heart in the Lord."
PHILEMON 1:20

294. PAUL WRITES TO PHILEMON

(PHILEMON 1:1-25)

MEMORY VERSE:

"Yes, brother, let me have joy from you in the Lord; refresh my heart in the Lord."

PHILEMON 1:20

Paul writes to Philemon...

CIRCLE THE CORRECT WORDS:

1. "I thank my God, making mention of you always in my prayers, hearing of your (**LOVE, HATE**) and (**FAITH, DOUBTING**) which you have toward the Lord Jesus and toward all the saints." **PHILEMON 1:4-5**
2. "For we have great joy and consolation in your love, because the hearts of the saints have been (**CRUSHED, REFRESHED**) by you, brother." **PHILEMON 1:7**
3. "I appeal to you for my son (**PAUL JR., ONESIMUS**), whom I have begotten while in my chains." **PHILEMON 1:10**

TRUE OR FALSE:

4. "I am sending him back. You therefore receive him, that is, my own heart, whom I wished to keep with me, that on your behalf he might minister to me in my chains for the gospel." **PHILEMON 1:12-13**
5. For perhaps he departed for a while for this purpose, that you might receive him never. **PHILEMON 1:15**

TRUE OR FALSE

TRUE OR FALSE

CIRCLE THE CORRECT WORDS:

6. "But if he has wronged you or owes you anything, put that on (**HIS, MY**) account." **PHILEMON 1:18**
7. "Having confidence in your obedience, I write to you, knowing that you will do even (**MORE, LESS**) than I say." **PHILEMON 1:21**

294. PAUL WRITES TO PHILEMON

(PHILEMON 1:1-25)

J F V N M V O L B B W V W P E
 W U B C N Y P R I S O N E R J
 S S G P E O A U O E Q U T A M
 S T R V R K M S A I N T S L G
 G O O E Q O K E I H N U U D O
 R L C V Y W F F L E V A L S V
 A M D C N A S I R I P A L Y S
 C J Z N H L R U T S H D A S P
 E B H C E R U P M A N P O M T
 I K R C Y I I L F I B I A U W
 A G K O M W R S Y F S L A B B
 G H K H T W N F T B A E E H H
 W G R R A H U Y B T O I N S C
 S P I R I T E H D L I L T O J
 A D E E S Z D R F U S D D H Y

BOLD
BROTHER
CHAINS
CHRIST
FAITH
FRIEND

GRACE
LOVE
ONESIMUS
PAUL
PHILEMON
PRAYERS

PRISONER
PROFITABLE
SAINTS
SLAVE
SPIRIT

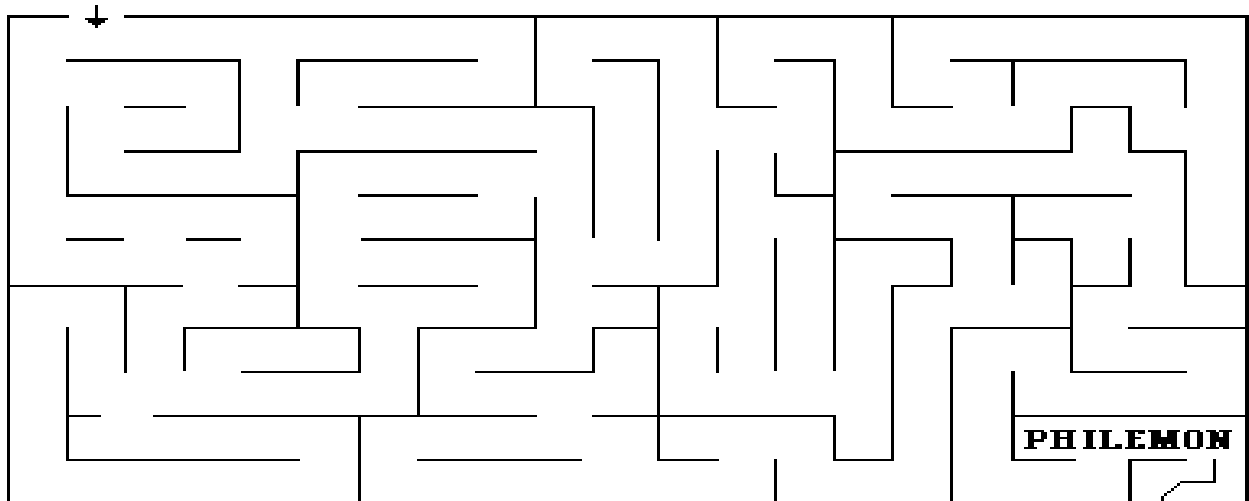

294. PAUL WRITES TO PHILEMON

(PHILEMON 1:1-25)

MEMORY VERSE:

"Yes, brother, let me have joy from you in the Lord; refresh my heart in the Lord."

PHILEMON 1:20

Paul writes to Philemon...

FILL IN THE BLANKS:

1. "I thank my God, making mention of you always in my prayers, hearing of your _____ and _____ which you have toward the Lord Jesus and toward all the saints."

PHILEMON 1:4-5

2. "For we have great joy and consolation in your love, because the hearts of the saints have been _____ by you, brother." PHILEMON 1:7

3. "I appeal to you for my son _____, whom I have begotten while in my chains."

PHILEMON 1:10

TRUE OR FALSE:

4. "I am sending him back. You therefore receive him, that is, my own heart, whom I wished to keep with me, that on your behalf he might minister to me in my chains for the gospel."

PHILEMON 1:12-13

TRUE OR FALSE

5. For perhaps he departed for a while for this purpose, that you might receive him never.

PHILEMON 1:15

TRUE OR FALSE

FILL IN THE BLANKS:

6. "But if he has wronged you or owes you anything, put that on _____."

PHILEMON 1:18

7. "Having confidence in your obedience, I write to you, knowing that you will do even _____ than I say." PHILEMON 1:21

294. PAUL WRITES TO PHILEMON

(PHILEMON 1:1-25)

A S W V B A Q Z S O B N R O H O P W T P O J V T A
 Z J J V I W D Z T J M U C J Q E T K V A B S F O E
 S F N E A B N K F J W O M F O B C I R B U M R N C
 D F V B M P E C A E U F L A C S R J F V L B K I N
 J O S Q B E I T Y A F L B H H W R O E Q P P K J A
 L O Z Y T S R I Y W I L B A A E S E T C H R I S T
 Q S K E Y G F O O L B M A H I B C S Y H M C Y J I
 I P A R E N O S I R P S C Z N K H U J A E D R Y Z
 K E B I L D J T F Z G Z W Y S S U E O D R R G T S
 T O Z L N E B E V B Y F J N A U E A U V C P I H N
 D O F N I T V A B P P P U J W H R O I V A S K G C
 G C H V O A S N S J Y G P T V K C V G S C T U F Z
 R F N Q L P B R V H B K K R A P N D F M V B A Y B
 A K G S V Z R P M G D B O E O E Q Q K C Z B V Q R
 C B N O M E L I H P R U P P M F L E D Z K G B D P
 E Y B T Q C B I A E C S I L F V I N B L B B O C J
 Y N G A Z C K Q S U G K T J S A K T K B K E O M P
 H M R Q U Q E P L W R C E C W R D R A T S I U L Q
 U H Q F A I I D Z U G U J V U L D H K B M K V P D
 Q L I H N R F J S D A M K T D W T Y A M L B Z O B
 O N E S I M U S H W N P K W S I O Y T O O E A E Q
 S D P T M W J Q M Y G D P H A J K D W E A P U A F
 S R H P G Z T R B P Z L Z F J U Q J L M T P E Y G
 I E Z J F K E I S Z J S Y P H O K I A X M U F U A
 L U I T H K J L V W P V Y J Q E L P P N Z Z P H M

BOLD
BROTHER
CHAINS
CHRIST
FAITH
FRIEND
GRACE

LOVE
ONESIMUS
PAUL
PHILEMON
PRAYERS
PRISONER

PROFITABLE
SAINTS
SAVIOR
SLAVE
SPEAK
SPIRIT

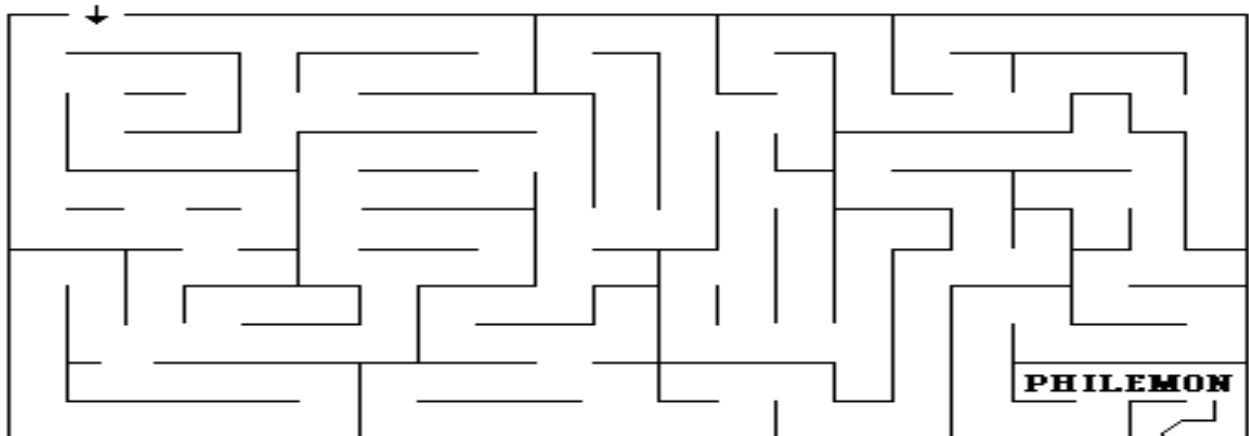

294. PAUL WRITES TO PHILEMON

(PHILEMON 1:1-25)

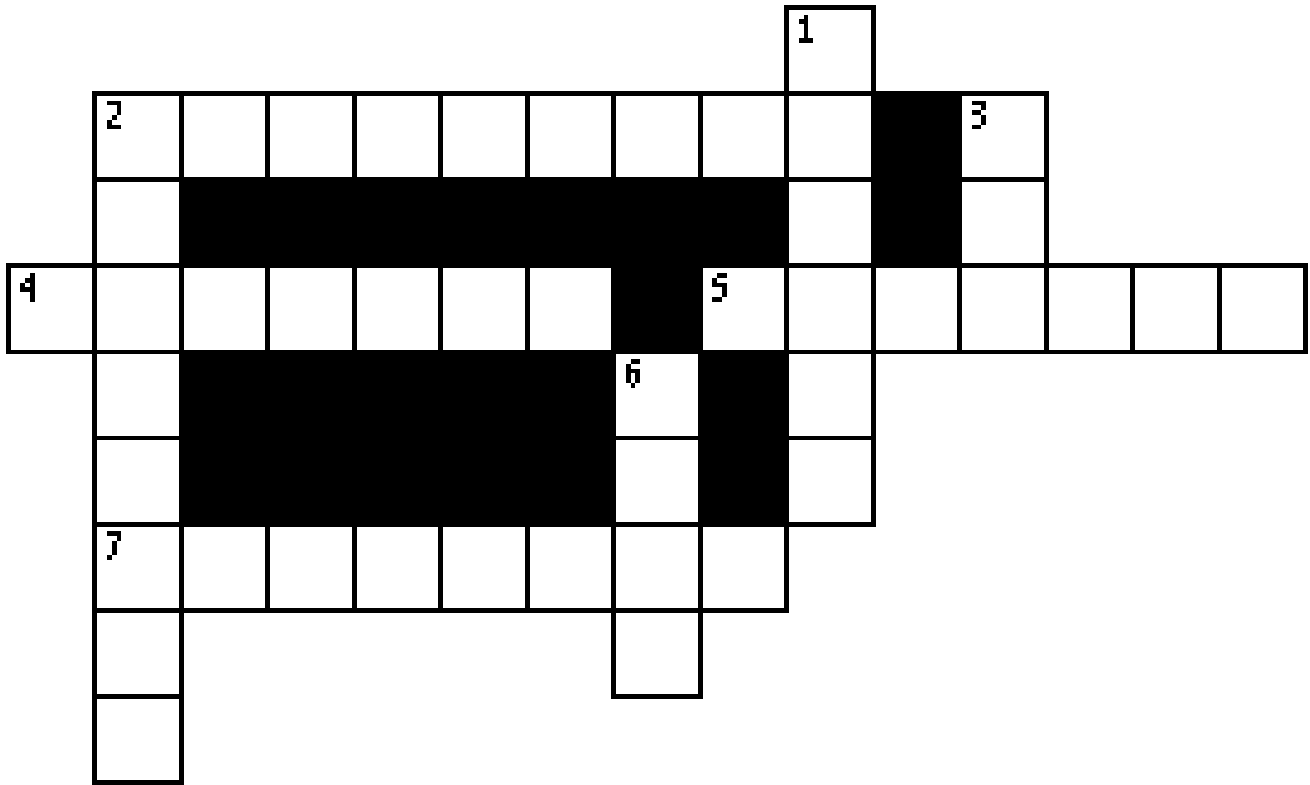

- 5 ACROSS "I thank my God, making mention of you always in my _____, hearing of your love and faith which you have toward the Lord Jesus and toward all the saints." **PHILEMON 1:4-5**
- 1 DOWN "For we have great joy and consolation in your love, because the _____ of the saints have been refreshed by you, brother." **PHILEMON 1:7**
- 2 DOWN "I appeal to you for my son _____, whom I have begotten while in my chains." **PHILEMON 1:10**
- 7 ACROSS "I am sending him back. You therefore receive him, that is, my own heart, whom I wished to keep with me, that on your behalf he might _____ to me in my chains for the gospel." **PHILEMON 1:12-13**
- 4 ACROSS "For perhaps he departed for a while for this purpose, that you might _____ him forever." **PHILEMON 1:15**
- 6 DOWN "But if he has wronged you or _____ you anything, put that on my account." **PHILEMON 1:18**
- 3 DOWN "Yes, brother, let me have _____ from you in the Lord; refresh my heart in the Lord." **PHILEMON 1:20**
- 2 ACROSS "Having confidence in your _____, I write to you, knowing that you will do even more than I say." **PHILEMON 1:21**

Bible Story 295

OUR GREAT HIGH PRIEST

HEBREWS 4:14-5:11

295. OUR GREAT HIGH PRIEST
(HEBREWS 4:14-5:11)

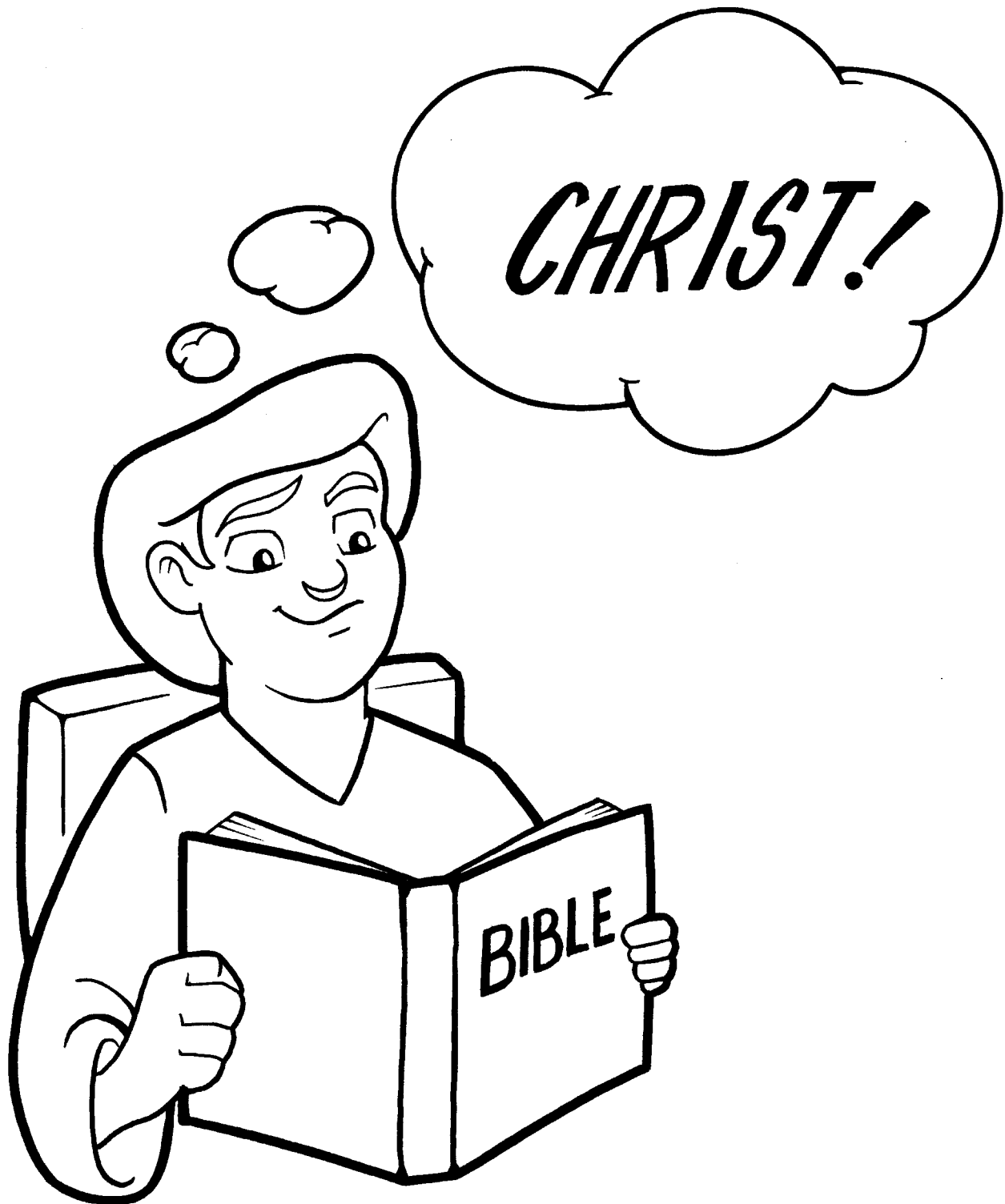

"And being made perfect, he became the author of eternal salvation unto all them that obey him;"
HEBREWS 5:9

295. OUR GREAT HIGH PRIEST (HEBREWS 4:14-5:11)

MEMORY VERSE:

"Let us therefore come boldly to the throne of grace, that we may obtain mercy and find grace to help in time of need." HEBREWS 4:16

TRUE OR FALSE:

1. "Seeing then that we have a great High Priest who has passed through the heavens, Jesus the Son of God, let us hold fast our confession." HEBREWS 4:14

TRUE OR FALSE

2. "For we do not have a High Priest who cannot sympathize with our weaknesses, but was in all points tempted as we are, yet without sin." HEBREWS 4:15

TRUE OR FALSE

CIRCLE THE CORRECT WORDS:

3. "Let us therefore come (**BOLDLY, COLDLY**) to the throne of grace, that we may obtain mercy and find grace to help in time of need." HEBREWS 4:16

4. "So also Christ did not glorify Himself to become High Priest, but it was He who said to Him: 'You are My Son, Today I have (**BEGOTTEN, FORGOTTEN**) You.'" HEBREWS 5:5

5. "As He also say in another place: 'You are a priest forever According to the order of (**MELCHIOR, MELCHIZEDEK**).'" HEBREWS 5:6

TRUE OR FALSE:

6. "And having been perfected, He became the author of eternal salvation to all who obey Him." HEBREWS 5:9

TRUE OR FALSE

295. OUR GREAT HIGH PRIEST

(HEBREWS 4:14-5:11)

M S Y M P A T H I Z E H N Z J
E S O N O F G O D Z I S J E I
L R L C L C S Z T G A K S U V
C M Y U P M M A H C I U L N D
H J M R P E K P R C S H I I E
I L T S H R R I O S U S D J T
Z P F J L I F F N G T N R L P
E O H L E I I K E U B E Z M M
D L D S C B R R O C W V B P E
E T T E Q G Y H F I T A Y B T
K P S P U C T V G F V E A E M
L N R B R I K Z R L K H D C T
J R S E W B Q Y A B G C E H Q
B A M R I I Y E C K P O M M V
B P M S C V C H E M H V B B U

HEAVENS
HIGH PRIEST
JESUS
MELCHIZEDEK

MERCY
PERFECTED
SACRIFICES
SON OF GOD

SYMPATHIZE
TEMPTED
THRONE OF GRACE
WITHOUT SIN

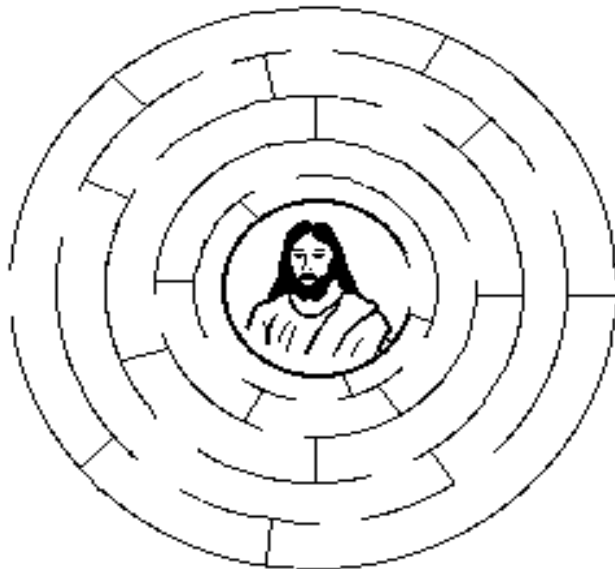

295. OUR GREAT HIGH PRIEST (HEBREWS 4:14-5:11)

MEMORY VERSE:

"Let us therefore come boldly to the throne of grace, that we may obtain mercy and find grace to help in time of need." HEBREWS 4:16

TRUE OR FALSE:

1. "Seeing then that we have a great High Priest who has passed through the heavens, Jesus the Son of God, let us hold fast our confession." HEBREWS 4:14

TRUE OR FALSE

2. "For we do not have a High Priest who cannot sympathize with our weaknesses, but was in all points tempted as we are, yet without sin." HEBREWS 4:15

TRUE OR FALSE

FILL IN THE BLANKS:

3. "Let us therefore come _____ to the throne of grace, that we may obtain mercy and find grace to help in time of need." HEBREWS 4:16

4. "So also Christ did not glorify Himself to become High Priest, but it was He who said to Him: 'You are My Son, Today I have _____ You.'" HEBREWS 5:5

5. "As He also say in another place: 'You are a priest forever According to the order of _____.'" HEBREWS 5:6

TRUE OR FALSE:

6. "And having been perfected, He became the author of eternal salvation to all who obey Him." HEBREWS 5:9

TRUE OR FALSE

295. OUR GREAT HIGH PRIEST

(HEBREWS 4:14-5:11)

T N K O Y E B G U W A O U C E J D C B U H Z C K T
 B D E T C E F R E P H A H N N O V V B A G S Y J E
 I M Q T O A M Z K J A W P Q R W S Z G V F N U M U
 A G J A F W W J C U H V E L S T I K E B Y C D V S
 M F B N V L U P U K Z M V K A U S T I O Q Z Y W S
 B H H E A V E N S O Y F A D L G M E H U D B G Z F
 T A B R B Z F N M I N S R D V F C F I O C R T F J
 Y W R S E C I F I R C A S O A K Z K K R U P I I S
 L B B P S B I U D T J W L K T D L T E M P T E D G
 I P K I V P B O L E T U W Q I B U S B V M H S Z R
 O E E Q M J G F S J P D J K O K T M P Z P J G I A
 B S F D A H Y L V K L S T L N K M O P A O P I I N
 E G J J Z G P L R K J J U H Y A O A U U E Q P T H
 G D T Q S E Y M C P C H O W R T E T Z E A B G M S
 O E K E D E Z I H C L E M K Y O M M V F Y Q C G F
 T P E R H U B Y C R E M E I D W N Z F P J F J G N
 T Z J I M W D S M Z V Q P J J L B E R T U E N R T
 E C Z L B D R Z D Y T O T S I A N J O O H G S H Q
 N C Z S S W C F L O W E C U P P O S K F A A H U C
 V Q K T V Y G P B Y G W S E T P B M K N G M E U S
 S Y M P A T H I Z E H F C A V A U B Y I E R D V D
 Q I C F O P R G B O P E O V R B L P R J C M A Y Y
 Z W T A J Z G K A J J B H N F V P C G J N A B C R
 U Z D E R E F F U S H K U D O Q M D I Y A O Y Y E
 A K I Y J W N B C F Q S E Q E S C T K T I K K R Q

BEGOTTEN
 HEAVENS
 HIGH PRIEST
 JESUS
 MELCHIZEDEK

MERCY
 PERFECTED
 SACRIFICES
 SALVATION
 SON OF GOD

SUFFERED
 SYMPATHIZE
 TEMPTED
 THRONE OF GRACE
 WITHOUT SIN

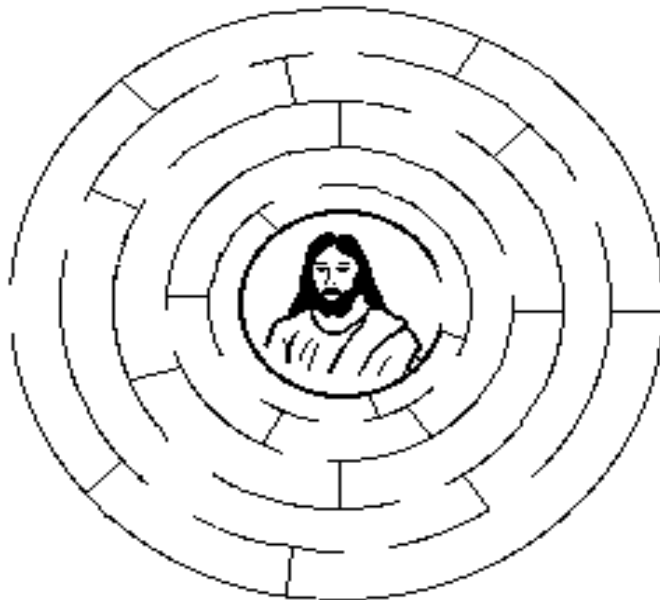

295. OUR GREAT HIGH PRIEST

(HEBREWS 4:14-5:11)

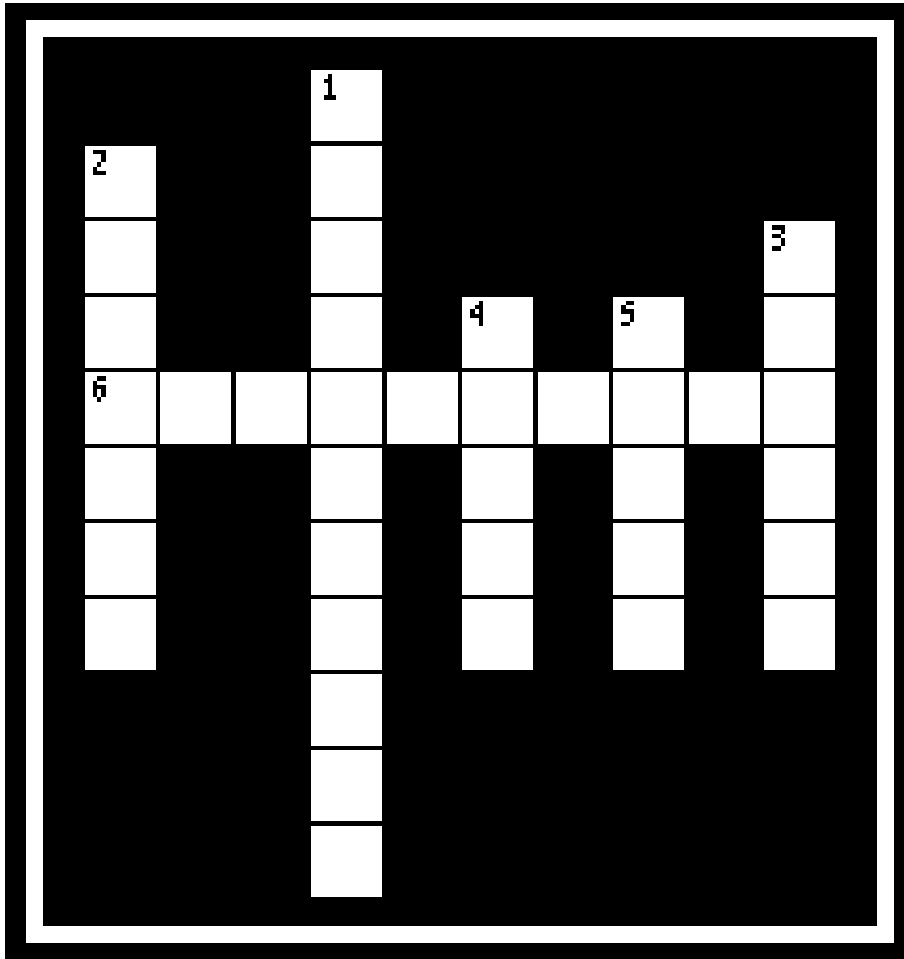

- 5 DOWN "Seeing then that we have a great High Priest who has passed through the heavens, _____ the Son of God, let us hold fast our confession." **HEBREWS 4:14**
- 2 DOWN "For we do not have a High Priest who cannot sympathize with our weaknesses, but was in all points tempted as we are, yet _____ sin." **HEBREWS 4:15**
- 4 DOWN "Let us therefore come boldly to the throne of _____, that we may obtain mercy and find grace to help in time of need." **HEBREWS 4:16**
- 6 ACROSS "So also Christ did not glorify Himself to become _____ _____, but it was He who said to Him: 'You are My Son, Today I have begotten You.'" **HEBREWS 5:5**
- 1 DOWN "As He also say in another place: 'You are a priest forever According to the order of _____.'" **HEBREWS 5:6**
- 3 DOWN "And having been perfected, He became the _____ of eternal salvation to all who obey Him." **HEBREWS 5:9**

Bible Story 296

**THE JUST
LIVE
BY FAITH**

HEBREWS 10:26-39

296. THE JUST LIVE BY FAITH
(HEBREWS 10:26-39)



"Now the just shall live by faith..."
HEBREWS 10:38

296. THE JUST LIVE BY FAITH (HEBREWS 10:26-39)

MEMORY VERSE:

"Now the just shall live by faith..." HEBREWS 10:38

CIRCLE THE CORRECT WORDS:

1. "Anyone who has (**ACCEPTED, REJECTED**) Moses' law dies without mercy on the testimony of two or three witnesses." **HEBREWS 10:28**
2. "Of how much (**WORSE, LESS**) punishment, do you suppose, will he be thought worthy who has trampled the Son of God underfoot, counted the blood of the covenant by which he was sanctified a common thing, and insulted the Spirit of grace?" **HEBREWS 10:29**

TRUE OR FALSE:

3. "It is a fearful thing to fall into the hands of the living God." **HEBREWS 10:31**
TRUE OR FALSE

The writer of the Book of Hebrews writes...

4. "But recall the former days in which, after you were illuminated, you endured a great struggle with sufferings." **HEBREWS 10:32**
TRUE OR FALSE

CIRCLE THE CORRECT WORDS:

5. "For you had compassion on me in my chains, and joyfully accepted the plundering of your goods, knowing that you have a better and an enduring possession for yourselves in (**HEAVEN, EARTH**)." **HEBREWS 10:34**
6. "For you have need of endurance, so that after you have done the will of God, you may receive the (**LETTER, PROMISE**)." **HEBREWS 10:36**

296. THE JUST LIVE BY FAITH

(HEBREWS 10:26-39)

S F J O S B V O C Q R I D I J
A A C A J K A E H E O J Q P G
C H V W H S R P W L B S E T N
R A T V Q U L A U J U S T N I
I H S G N I R E F F U S N E V
F Z W M O D N T E B Q U R M A
I Y H F E I F A I T H E Y G S
C N P S S H W N E V A E H D O
E T N E M H S I N U P T Y U U
Z J J W W E V I E C E R D J G
Y T Y L L U F Y O J K U L T F
Y L I V E P J C C D L T U V K
C O M P A S S I O N W H O R D
O P H U E E U S N D K A S F B
J L Q D E S I M O R P V J E K

COMPASSION
FAITH
HEAVEN
JOYFULLY
JUDGMENT
JUST

LIVE
PROMISE
PUNISHMENT
RECEIVE
REWARD
SACRIFICE

SAVING
SIN
SOUL
SUFFERINGS
TRUTH



296. THE JUST LIVE BY FAITH

(HEBREWS 10:26-39)

MEMORY VERSE:

"Now the just shall live by faith..." HEBREWS 10:38

FILL IN THE BLANKS:

1. "Anyone who has _____ Moses' law dies without mercy on the testimony of two or three witnesses." **HEBREWS 10:28**
2. "Of how much _____ punishment, do you suppose, will he be thought worthy who has trampled the Son of God underfoot, counted the blood of the covenant by which he was sanctified a common thing, and insulted the Spirit of grace?" **HEBREWS 10:29**

TRUE OR FALSE:

3. "It is a fearful thing to fall into the hands of the living God." **HEBREWS 10:31**
TRUE OR FALSE

The writer of the Book of Hebrews writes...

4. "But recall the former days in which, after you were illuminated, you endured a great struggle with sufferings." **HEBREWS 10:32**
TRUE OR FALSE

FILL IN THE BLANKS:

5. "For you had compassion on me in my chains, and joyfully accepted the plundering of your goods, knowing that you have a better and an enduring possession for yourselves in _____." **HEBREWS 10:34**
6. "For you have need of endurance, so that after you have done the will of God, you may receive the _____." **HEBREWS 10:36**

296. THE JUST LIVE BY FAITH

(HEBREWS 10:26-39)

W D E S P H A Q Z F E U O M J T Q P K F Q C B A Q
 P E S I M O R P Z A A F F L F W O T I E D C B V D
 P J O L H P N I K Y W I L B A J E C J J V V G B C
 W Q U Z Z J M W C Y L B L B H T O S S O S Z E O M
 Q O O K I T G Z T O Z G M A E H N Y U U M K I U P
 S I C B V B F K I F B Y S C A P W E F G C B K V O
 T R F Z V I H K O V P P Z W V J E C M U Z K B Z E
 A K E E C I F I R C A S F J E H B H E G L S P A A
 U T K C B A A Q T B J Y P U N Q K U A F D L P U Y
 U D B F E M W T A S H B G K H O S E V K L U Y E U
 H Y Y H Q I S J N V G D K O A A U C D D U M J F H
 T H N N Y U V B R M E R C I H D H N Q B T O U P A
 R U M G J B B E P A U C B O R W P Q E K M A Z T E
 U Q H B E T P B I Z W G U A M V E L N K O T V O C
 T S S G N I R E F F U S W T Z P V K R A E M F N N
 H S L G L Y E R Q S D E K E Y M A D Y T M Z R I A
 E I D R N L S B D H R R C J N F A S Y W B J K J I
 R L R Q V I G K J M W G U K J S R D S L N S K J Z
 J S E G Q O D E Q B Y N M K T W L H D I O M Y Y S
 S J L N T V E F R S P G D P P U T O J A O B N I S
 P U N I S H M E N T Z Z L Z L I W K I P B N R T N
 T F U V V Q P J I V W J S Y A D J Q P P U P G H C
 A F W A A E Z T L O B P V F J S U K T A L C B G Z
 Z O J S Q Z C E S J M N R Y C J O L V B P D B B B
 S P N I B U C J T J W U C O V H E W R V M T U Y R

COMPASSION
 FAITH
 HEAVEN
 JOYFULLY
 JUDGMENT
 JUST

LIVE
 PROMISE
 PUNISHMENT
 RECEIVE
 REWARD
 SACRIFICE

SAVING
 SIN
 SOUL
 SUFFERINGS
 TRUTH



296. THE JUST LIVE BY FAITH

(HEBREWS 10:26-39)

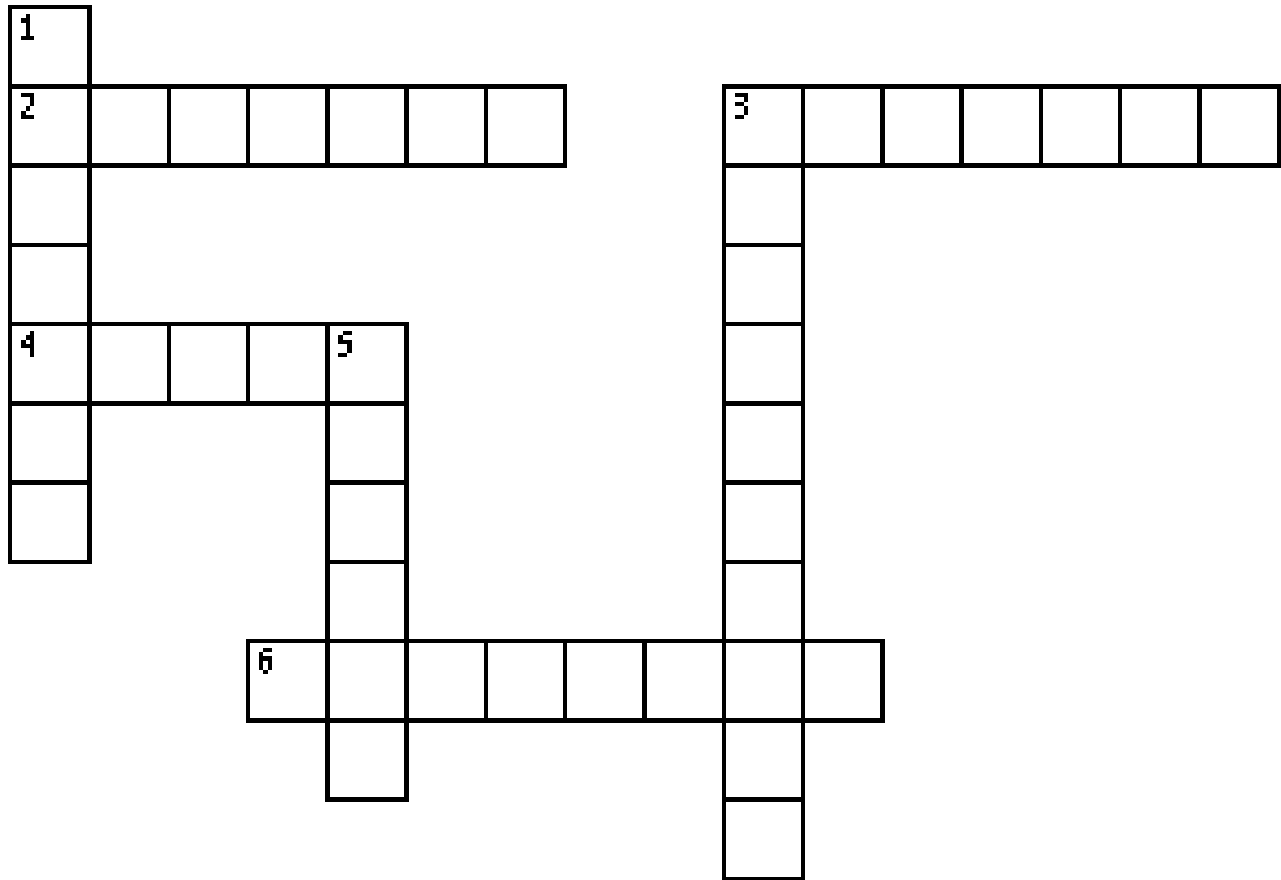

- 6 ACROSS "Anyone who has _____ Moses' law dies without mercy on the testimony of two or three witnesses." **HEBREWS 10:28**
- 3 DOWN "Of how much worse _____, do you suppose, will he be thought worthy who has trampled the Son of God underfoot, counted the blood of the covenant by which he was sanctified a common thing, and insulted the Spirit of grace?" **HEBREWS 10:29**
- 1 DOWN "It is a _____ thing to fall into the hands of the living God." **HEBREWS 10:31**
- 2 ACROSS "But recall the former days in which, after you were illuminated, you _____ a great struggle with sufferings." **HEBREWS 10:32**
- 5 DOWN "For you had compassion on me in my chains, and joyfully accepted the plundering of your goods, knowing that you have a better and an enduring possession for yourselves in _____." **HEBREWS 10:34**
- 3 ACROSS "For you have need of endurance, so that after you have done the will of God, you may receive the _____." **HEBREWS 10:36**
- 4 ACROSS "Now the just shall live by _____..." **HEBREWS 10:38**

Bible Story 297

**FAITH
WITHOUT WORKS
IS DEAD**

JAMES 2:14-26



FAITH
WITHOUT WORKS
IS DEAD

JAMES 2:14-26

297. FAITH WITHOUT WORKS IS DEAD

(JAMES 2:14-26)

MEMORY VERSE:

"For as the body without the spirit is dead, so faith without works is dead also."
JAMES 2:26

CIRCLE THE CORRECT WORDS:

1. "What does it profit, my brethren, if someone says he has faith but **(DOES, DOES NOT)** have works? Can faith save him?" **JAMES 2:14**
2. "Thus also faith by itself, if it does not have works, is **(ASLEEP, DEAD)**." **JAMES 2:17**

TRUE OR FALSE:

3. "But someone will say, 'You have faith, and I have works.' Show me your faith without your works, and I will show you my faith by my works." **JAMES 2:18**
TRUE OR FALSE

CIRCLE THE CORRECT WORDS:

4. "Was not **(JACOB, ABRAHAM)** our father justified by works when he offered Isaac his son on the altar?" **JAMES 2:21**
5. "Do you see that faith was working **(TOGETHER, APART)** with his works, and by works faith was made perfect?" **JAMES 2:22**

TRUE OR FALSE:

6. "And the Scripture was fulfilled which says, 'Abraham believed God, and it was accounted to him for righteousness.'..." **JAMES 2:23**
TRUE OR FALSE
7. "...And he was called the friend of God." **JAMES 2:23**
TRUE OR FALSE

CIRCLE THE CORRECT WORD(S):

8. "You see then that a man **(IS, IS NOT)** justified by works and not by faith only." **JAMES 2:24**

297. FAITH WITHOUT WORKS IS DEAD

(JAMES 2:14-26)

Y S C R I P T U R E B S Z W H
 T D P R O F I T A H W F N O Q
 O K O B F V H N N F T F S R P
 G U G B N D Q S Z I M I I K O
 E Q H B B K E E I L U K A S K
 T I A B R A H A M L T E V F K
 H L U K C G H V D E O H W Z U
 E B F N B P Q A Q D Y O P O H
 R U F O Y S N T R G E I F C S
 N Z S C P W V E C O E G C U E
 K U R I Q Y Q N P D N M P W B
 Y R R H J U S T I F I E D O F
 B I Z Z R T D Y W D E M R A W
 T G W M F Y A L R A Q D Y R Z
 B D N T S A V E V E I L E B S

ABRAHAM
 BELIEVE
 DEAD
 FAITH
 FILLED
 GOD

FOOLISH
 JUSTIFIED
 PROFIT
 RAHAB
 SAVE
 BODY

SCRIPTURE
 SPIRIT
 TOGETHER
 WARMED
 WORKS

FAITH WITH OUT WORKS

FAITH THAT WORKS

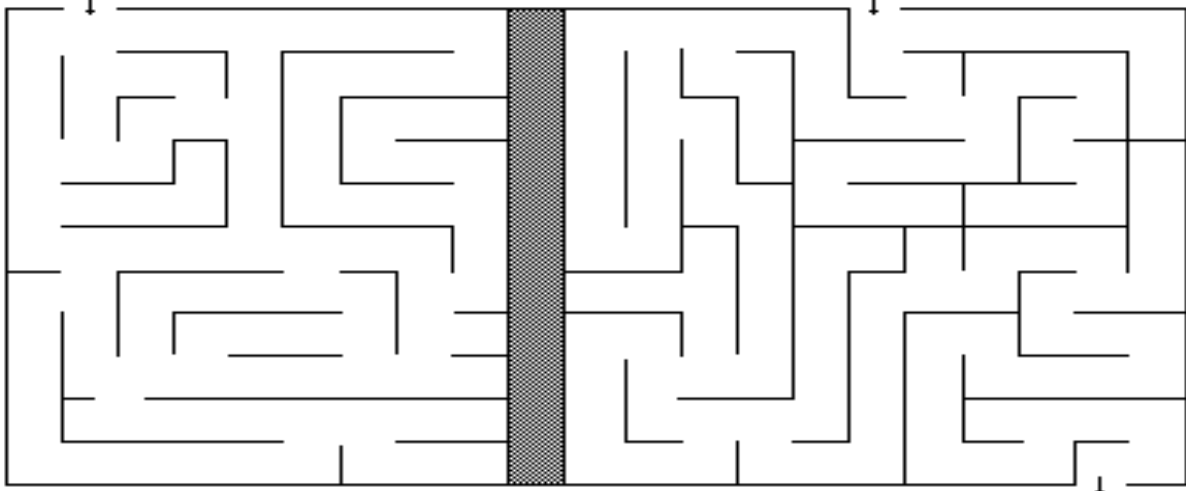

297. FAITH WITHOUT WORKS IS DEAD

(JAMES 2:14-26)

MEMORY VERSE:

"For as the body without the spirit is dead, so faith without works is dead also."
JAMES 2:26

FILL IN THE BLANKS:

1. "What does it profit, my brethren, if someone says he has faith but _____ have works? Can faith save him?" **JAMES 2:14**
2. "Thus also faith by itself, if it does not have works, is _____." **JAMES 2:17**

TRUE OR FALSE:

3. "But someone will say, 'You have faith, and I have works.' Show me your faith without your works, and I will show you my faith by my works." **JAMES 2:18**
TRUE OR FALSE

FILL IN THE BLANKS:

4. "Was not _____ our father justified by works when he offered Isaac his son on the alter?" **JAMES 2:21**
5. "Do you see that faith was working _____ with his works, and by works faith was made perfect?" **JAMES 2:22**

TRUE OR FALSE:

6. "And the Scripture was fulfilled which says, 'Abraham believed God, and it was accounted to him for righteousness.'..." **JAMES 2:23**
TRUE OR FALSE
7. "...And he was called the friend of God." **JAMES 2:23**
TRUE OR FALSE

FILL IN THE BLANK:

8. "You see then that a man is _____ by works and not by faith only." **JAMES 2:24**

297. FAITH WITHOUT WORKS IS DEAD

(JAMES 2:14-26)

G P Z Z E N M G K Q H C E Y P U G U L B
 S W V U Z S B Y W O R K S H L D I J E S
 F A Y G C C P Q A S I G Z F O I E L D R
 Z C V D L N R D G S P O U Q P V I G N V
 A P U E O P Y H S I L O O F D E O L K J
 N R D F W B R O S O K J U B V D G J A D
 S F W I C E E O A E U W S E Q E W T U U
 H M E L A C R K U S R P I H J M K B W V
 U E E L Z B B U T Z I J B M J N T V K C
 S T B E S C V I T R E V Q G C O O Q Y G
 Y L D D D B F P I P N H B Q G B H O Y O
 J M V F G I T T K P I Y V E B A T V E Q
 N W N Y E P O Z S E A R T W V S I Y H A
 D E A D P R J S Y U I H C G D P A B L E
 Y Z P R C E Q T B V E G B S D E F C B G
 I I Y I M M L V F R P M W B I W A J R R
 B I G F V E M A H A R B A W M J I D O A
 L D N B U H D G L F Q B Y D O H L N W H
 O Z W L I Y P W K I F U U I O N D B H A
 U P Y A P Y V D I U R V B C F F S L J B

ABRAHAM
 BELIEVE
 BODY
 DEAD
 FAITH
 FILLED

FOOLISH
 GOD
 JUSTIFIED
 RAHAB
 SAVE

SCRIPTURE
 SPIRIT
 TOGETHER
 WARMED
 WORKS

FAITH WITH OUT WORKS

FAITH THAT WORKS

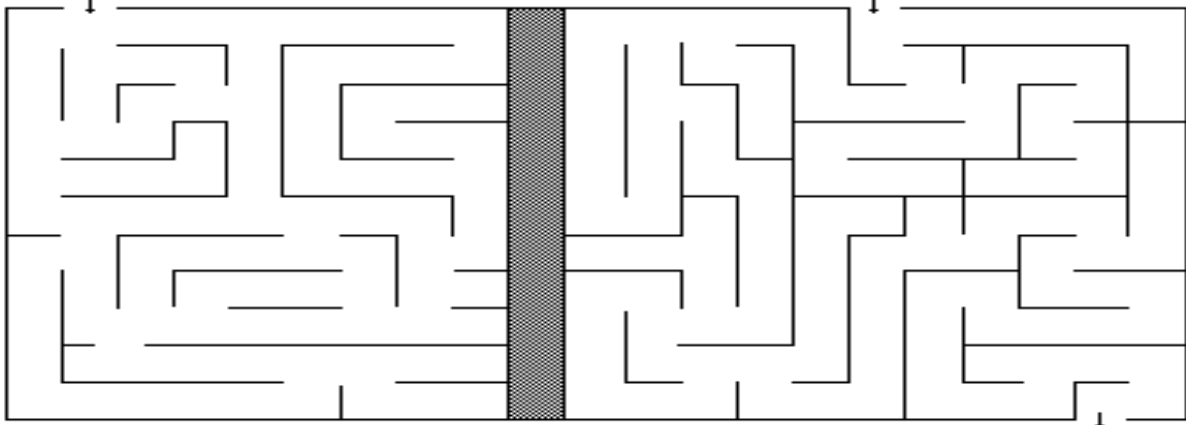

297. FAITH WITHOUT WORKS IS DEAD

(JAMES 2:14-26)

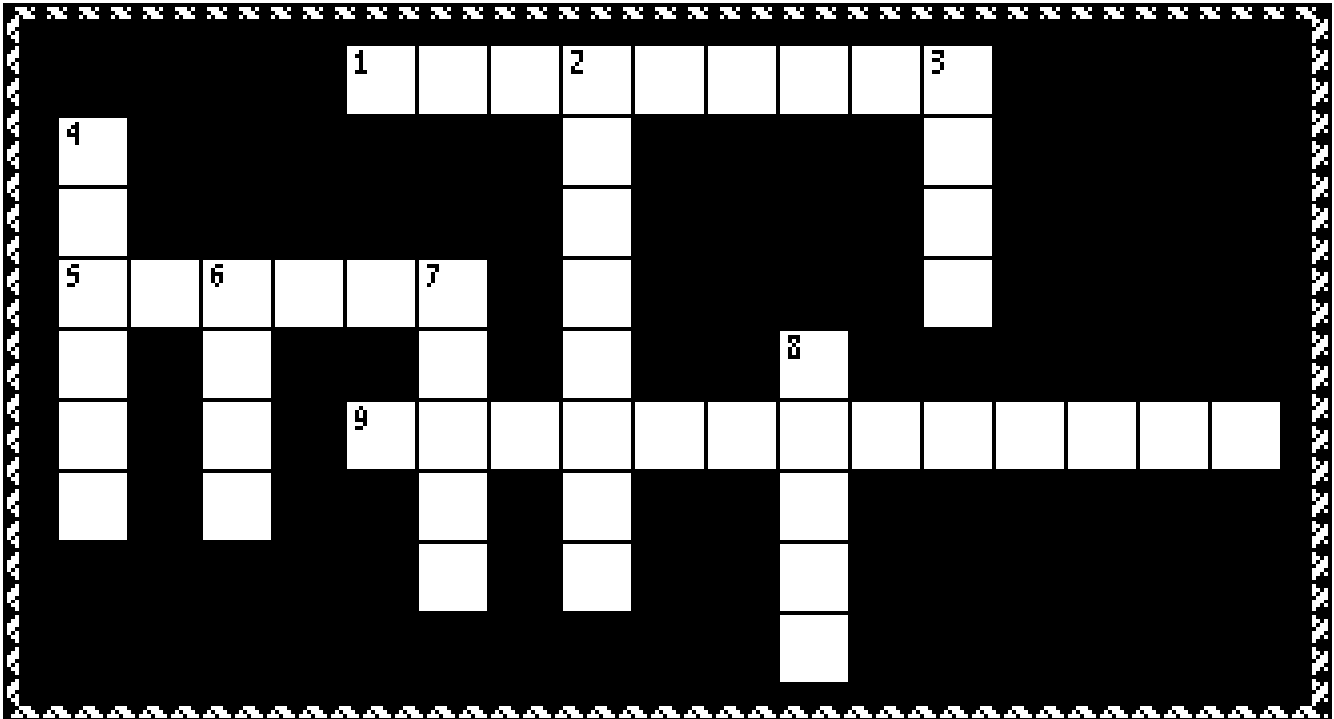

- 6 DOWN "What does it profit, my brethren, if someone says he has faith but does not have works? Can faith _____ him?" **JAMES 2:14**
- 5 ACROSS "Thus also faith by _____, if it does not have works, is dead." **JAMES 2:17**
- 7 DOWN "But someone will say, 'You have faith, and I have works.' Show me your faith without your works, and I will show you my _____ by my works." **JAMES 2:18**
- 1 ACROSS "Was not Abraham our father _____ by works when he offered Isaac his son on the altar?" **JAMES 2:21**
- 2 DOWN "Do you see that faith was working _____ with his works, and by works faith was made perfect?" **JAMES 2:22**
- 9 ACROSS "And the Scripture was fulfilled which says, 'Abraham believed God, and it was accounted to him for _____.'..." **JAMES 2:23**
- 4 DOWN "...And he was called the _____ of God." **JAMES 2:23**
- 8 DOWN "You see then that a man is justified by _____ and not by faith only." **JAMES 2:24**
- 3 DOWN "For as the body without the spirit is dead, so faith without works is _____ also." **JAMES 2:26**

Bible Story 298

CONCERNING FIERY TRAILS

1 PETER 4:12-19

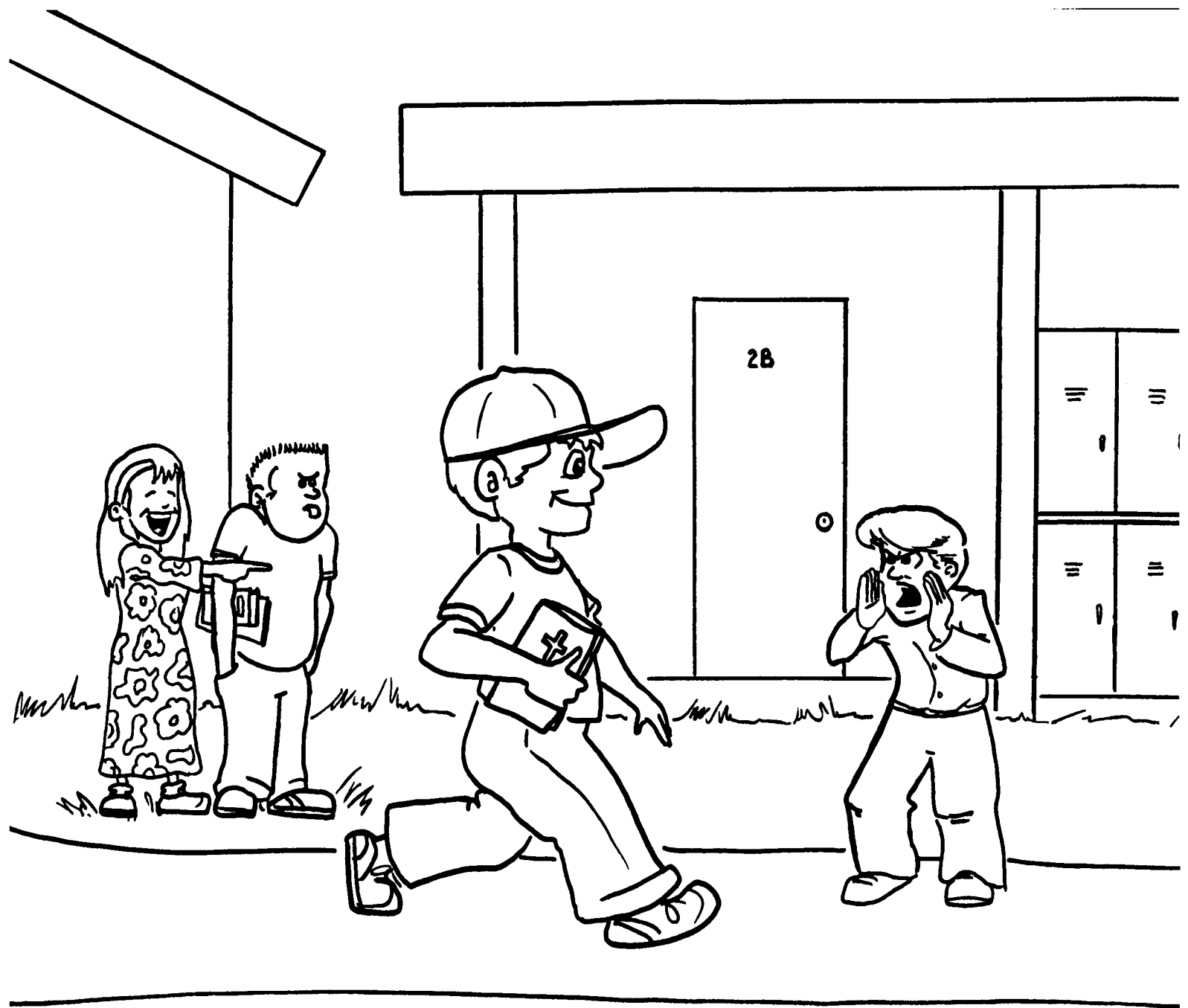

Concerning
the
Fiery Trials
1 Peter 4:12-19

298. CONCERNING THE FIERY TRIALS

(1 PETER 4:12 -19)

MEMORY VERSE:

"Therefore let those who suffer according to the will God commit their souls to Him in doing good, as to a faithful Creator." 1 PETER 4:19

TRUE OR FALSE:

1. "Beloved, do not think it strange concerning the fiery trial which is to try you, as though some strange thing happened to you." **1 PETER 4:12**
TRUE OR FALSE
2. "But rejoice to the extent that you partake of Christ's sufferings, that when His glory is revealed, you may also be glad with exceeding joy." **1 PETER 4:13**
TRUE OR FALSE

CIRCLE THE CORRECT WORDS:

3. "Yet if anyone (**SUFFERS, SLEEPS**) as a Christian, let him not be ashamed, but let him glorify God in this matter." **1 PETER 4:16**
4. "For the time has come for (**JUDGMENT, CLEANING**) to begin at the house of God; and if it begins with us first, what will be the end of those who do not obey the gospel of God?"
1 PETER 4:17

TRUE OR FALSE:

5. "Therefore let those who suffer according to the will God commit their souls to Him in doing good, as to a faithful Creator." **1 PETER 4:19**
TRUE OR FALSE

298. CONCERNING FIERY TRIALS

(1 PETER 4:12-19)

T S L A I R T C D Y S L G M R
B Y N P C Q F T J Y H Z E W C
I L M E C J J I Q O M B U U G
A G L A D B T O T F B P W F R
C I E C I O J E R S G L O R Y
M R G S Q B E T R V I J D I G
S O E G I R J A I B S R W B N
P V F A W B Z N L S V H H G G
I N A I T S I R H C O D R C Z
R Q H D Y O J R S V J E G Y J
I Z A E Z Y R P T M F S Y O P
T U W P K K R I F F J S P P D
S T R A N G E E U A E E Z Y N
B A B Z K E Z S I Z A L W B U
T S L U O S K Q A F W B B D O

BLESSED
CHRISTIAN
CHRIST
CREATOR
FIERY

GLAD
GLORY
GOD
JOY
REJOICE

SOULS
SPIRIT
STRANGE
SUFFER
TRIALS

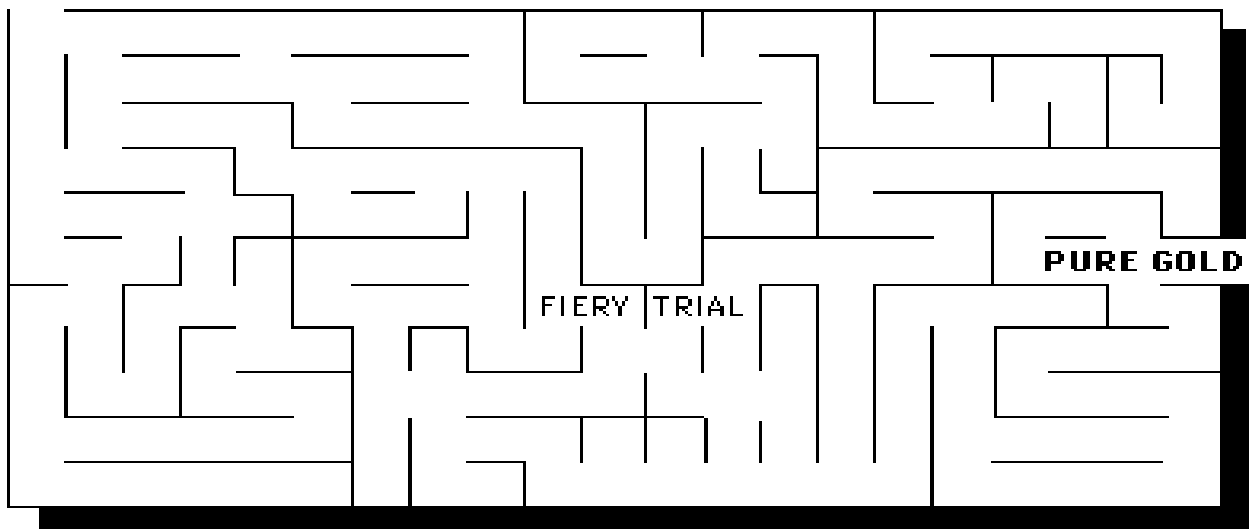

298. CONCERNING THE FIERY TRIALS

(1 PETER 4:12 -19)

MEMORY VERSE:

"Therefore let those who suffer according to the will God commit their souls to Him in doing good, as to a faithful Creator." 1 PETER 4:19

TRUE OR FALSE:

1. "Beloved, do not think it strange concerning the fiery trial which is to try you, as though some strange thing happened to you." **1 PETER 4:12**
TRUE OR FALSE
2. "But rejoice to the extent that you partake of Christ's sufferings, that when His glory is revealed, you may also be glad with exceeding joy." **1 PETER 4:13**
TRUE OR FALSE

FILL IN THE BLANKS:

3. "Yet if anyone _____ as a Christian, let him not be ashamed, but let him glorify God in this matter." **1 PETER 4:16**
4. "For the time has come for _____ to begin at the house of God; and if it begins with us first, what will be the end of those who do not obey the gospel of God?" **1 PETER 4:17**

TRUE OR FALSE:

5. "Therefore let those who suffer according to the will God commit their souls to Him in doing good, as to a faithful Creator." **1 PETER 4:19**
TRUE OR FALSE

298. CONCERNING FIERY TRIALS

(1 PETER 4:12-19)

A A F R I S T T L Y B K Q R J K B B B O Q E E I Q C L D V B
M Z S L U O S F Z B U P O L S K U G O E B D U J S P I R I T
F S K Q A G E A B D K Z A W U A L E U A Q B S E T U M A Q E
H D B I M D J Y P R C Y W J E T P G V Y F Y S F F A A Y B A
K J Y P B E Z Y J C U Y V U A W M L Z D G K F S V U B S I F
N Q N H T P Z O H G M O M O V L C O A U E K J A I T T G P I
C I M Z Y Z K F G R D J F E D A C R U H A S S S T R A N G E
U K H I L C C V E G L F S P Q P D Y E A M J S G F E O M O M
Q S L V N A I T S I R H C T E P V A F E M M G E R K N B R I
D T U V I C T B U N S A W C N A Z I L C A V R Q L O K T A O
C D D F O Q I S W G V H U S R B K K P G O W A T N B V L V Q
N Y R B F I O V D Z R A D C Y V F B T N K Z S F I O E A K H
W H E Q V E T M W J C H S H Y Q K P O R E N N I S M F B R U
T U U Y Q W R A Y P M Z J U D F S P N A C F F H Y P M H W N
I Q W E Z Z A Z P N L Y H E J D A U I I Y I N W M F G O Y H
W S J L U K N S Z U B N Q C I V M I J Z U Z T U Z D S P C P
P S S L A I R T Y R E I F N P S O Z T S D T Q I U H L U B U
P I N N C K R H W O B J O Q T M A V J H Y M C K I D C V G Y
W L S V A H P M B F A T E L V C T F Y N F G D E K F Y L P N
Q S Z Q N Q R B M L C P W K R Z M R T C G U Y Y N W D R F M
T J K T M J I I W L W L E D F L Z K H Z T G L B M Y T R Q H
A F B A G B Q S S M J J B D E U J K G B I R R C C S L E K B
U F Z Q F B D V U T B C K O J T S Y F R I H Q T R K V V G Y
U O F F H R J O F S K V S K O M M R E C I O J E R E P U B A
H R I G H T E O U S O T U Q U O B G Y P P U T I D T A V Q O
E P H H A B Q J I Z I W H K G E P I Q J G V B O N E T T L M
R E N P W K R J B F T H P L F M C B D G C Y J W Y F J P O B
J O G J B E I E G P E P E W K B D U C O J Y O A J Y I I J R
S O B T P F L A Y G J J V K D N T A M D N R Y E D R P R V H
T C G B E J S W P K K H A I B O B V P P H T K P V N K F U N

BLESSED
CHRISTIAN
CHRIST
COMMIT
FAITHFUL CREATOR
FIERY TRIALS

GLAD
GLORY
GOD
JOY
REJOICE
RIGHTEOUS

SINNER
SOULS
SPIRIT
STRANGE
SUFFER

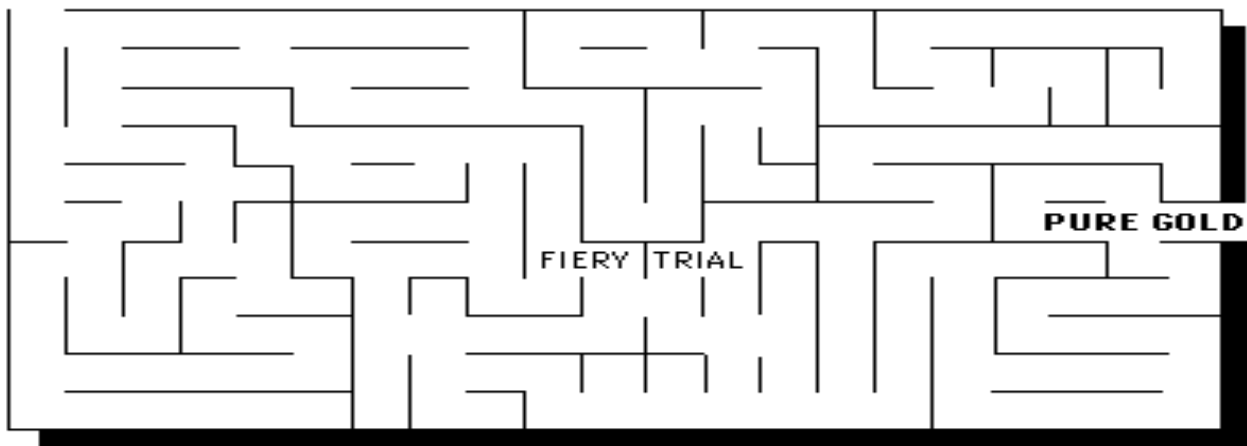

298. CONCERNING THE FIERY TRIALS

(1 PETER 4:12-19)

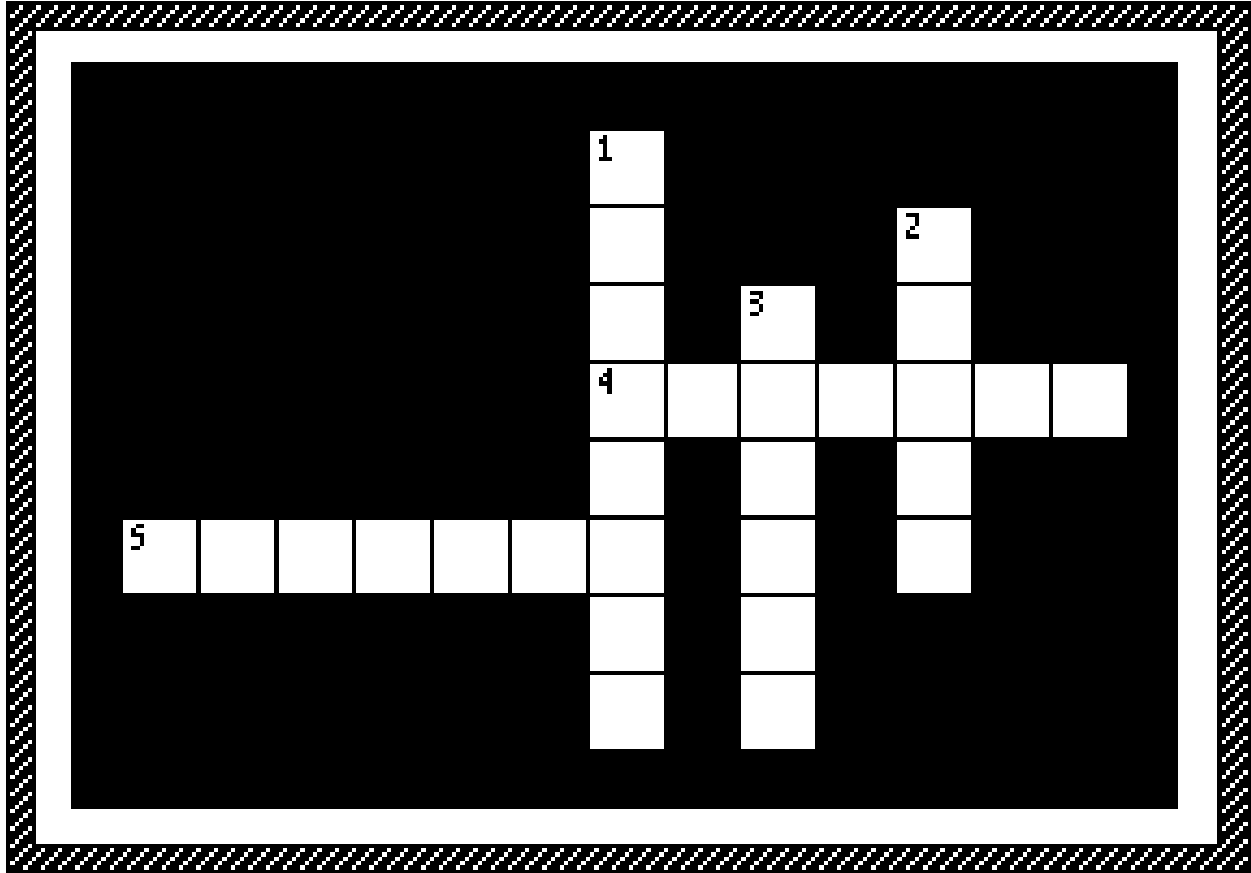

- 2 DOWN "Beloved, do not think it strange concerning the fiery _____ which is to try you, as though some strange thing happened to you." **1 PETER 4:12**
- 5 ACROSS "But rejoice to the extent that you _____ of Christ's sufferings, that when His glory is revealed, you may also be glad with exceeding joy." **1 PETER 4:13**
- 4 ACROSS "Yet if anyone suffers as a Christian, let him not be ashamed, but let him _____ God in this matter." **1 PETER 4:16**
- 1 DOWN "For the time has come for _____ to begin at the house of God; and if it begins with us first, what will be the end of those who do not obey the gospel of God?" **1 PETER 4:17**
- 3 DOWN "Therefore let those who suffer according to the will God _____ their souls to Him in doing good, as to a faithful Creator." **1 PETER 4:19**

Bible Story 299

**SUBMIT TO GOD,
RESIST THE DEVIL**

1 PETER 5:5-11

299. SUBMIT TO GOD, RESIST THE DEVIL
(1 PETER 5:5-11)



"Therefore humble yourselves under the mighty hand of God, that He may exalt you in due time."
1 PETER 5:6

299. SUBMIT TO GOD, RESIST THE DEVIL

(1 PETER 5:5-11)

MEMORY VERSE:

"Therefore humble yourselves under the mighty hand of God, that He may exalt you in due time." 1 PETER 5:6

TRUE OR FALSE:

1. "Likewise you younger people, submit yourselves to your elders. Yes, all of you be submissive to one another, and be clothed with humility..." **1 PETER 5:5**
TRUE OR FALSE
2. "...God resists the proud, But gives grace to the humble." **1 PETER 5:5**
TRUE OR FALSE

CIRCLE THE CORRECT WORDS:

3. "Therefore humble yourselves under the mighty hand of God, that He may (**EXIT, EXALT**) you in due time." **1 PETER 5:6**
4. "Casting all your care upon (**HIM, YOURSELF**) for He cares for you." **1 PETER 5:7**

TRUE OR FALSE:

5. Be sober, be vigilant; because your adversary the devil walks about like a roaring butterfly, seeking whom he may devour. **1 PETER 5:8**
TRUE OR FALSE
6. "Resist him, steadfast in the faith, knowing that the same sufferings are experienced by your brotherhood in the world." **1 PETER 5:9**
TRUE OR FALSE
7. "But may the God of all grace, who called us to His eternal glory by Christ Jesus, after you have suffered a while, perfect, establish, strengthen, and settle you." **1 PETER 5:10**
TRUE OR FALSE

CIRCLE THE CORRECT WORD:

8. "To (**HIM, YOU**) be the glory and the dominion forever and ever. Amen." **1 PETER 5:11**

299. SUBMIT TO GOD, RESIST THE DEVIL

(1 PETER 5:5-11)

I	L	I	V	E	D	T	J	O	B	Z	W	U	D	J
O	M	G	W	S	F	I	Q	F	S	B	K	O	G	P
V	G	D	Z	T	J	O	R	V	V	P	Y	F	R	N
Q	F	E	K	S	T	T	I	B	O	J	P	I	C	U
G	H	Y	T	I	L	I	M	U	H	G	L	O	R	Y
Z	R	P	K	S	E	A	L	S	J	H	Z	B	G	O
E	A	A	Q	E	J	N	S	V	T	I	M	B	U	S
B	W	Z	C	R	Z	R	T	M	J	G	W	G	R	F
A	S	U	S	E	J	T	S	I	R	H	C	Y	G	L
L	B	C	J	N	O	I	L	A	E	H	T	I	A	F
T	P	C	B	B	Z	P	F	Z	A	E	B	P	N	L
U	E	Q	B	K	K	I	A	S	S	R	E	D	L	E
S	U	F	F	E	R	I	N	G	S	U	M	Y	G	M
A	S	I	R	E	C	Q	Y	H	W	W	W	B	Z	S
N	D	U	O	R	P	D	Y	M	L	D	G	O	D	Z

CHRIST JESUS
DEVIL
ELDERS
EXALT
FAITH

GLORY
GOD
GRACE
HUMILITY

LION
PROUD
RESISTS
SUBMIT
SUFFERINGS

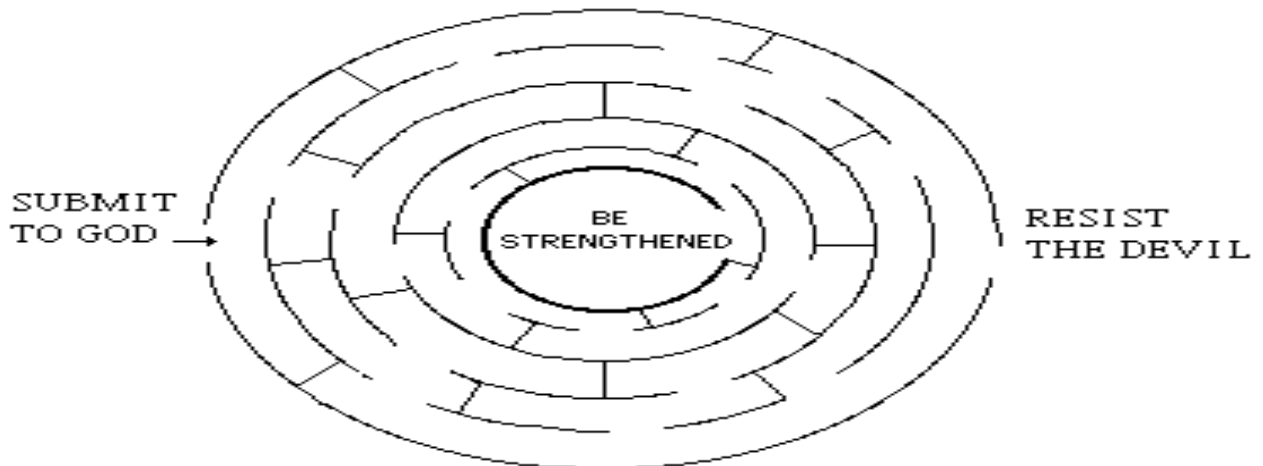

299. SUBMIT TO GOD, RESIST THE DEVIL

(1 PETER 5:5-11)

MEMORY VERSE:

"Therefore humble yourselves under the mighty hand of God, that He may exalt you in due time." 1 PETER 5:6

TRUE OR FALSE:

1. "Likewise you younger people, submit yourselves to your elders. Yes, all of you be submissive to one another, and be clothed with humility..." **1 PETER 5:5**
TRUE OR FALSE
2. "...God resists the proud, But gives grace to the humble." **1 PETER 5:5**
TRUE OR FALSE

FILL IN THE BLANKS:

3. "Therefore humble yourselves under the mighty hand of God, that He may _____ you in due time." **1 PETER 5:6**
4. "Casting all your care upon _____ for He cares for you." **1 PETER 5:7**

TRUE OR FALSE:

5. Be sober, be vigilant; because your adversary the devil walks about like a roaring butterfly, seeking whom he may devour. **1 PETER 5:8**
TRUE OR FALSE
6. "Resist him, steadfast in the faith, knowing that the same sufferings are experienced by your brotherhood in the world." **1 PETER 5:9**
TRUE OR FALSE
7. "But may the God of all grace, who called us to His eternal glory by Christ Jesus, after you have suffered a while, perfect, establish, strengthen, and settle you." **1 PETER 5:10**
TRUE OR FALSE

FILL IN THE BLANK:

8. "To _____ be the glory and the dominion forever and ever. Amen." **1 PETER 5:11**

299. SUBMIT TO GOD, RESIST THE DEVIL

(1 PETER 5:5-11)

T M K C T B W B M C Z W E T S T P B T V P A Q P M
 B S T S I S E R S M Y H W C U V A U M F T Y B G G
 I G K T F S D D Z L Y P E S E S B L Z R O U Q C G
 A F Q I A V W R F B O J B C P H T P J K N H F J R
 M H J O Y O Y C P B J H K H E R S E S K I A G N H
 B A G R A C E G G A F Q S U R F V I A Y J E A H U
 T H B T Y J P R K C A O U E F E Q M L D J C M E V
 Y W U S G N I R E F F U S C E J D C M B F N M D Y
 L B B M O J Z G B W H A H N C O V G W R A A A B Y
 I P R A I E W N U J A W P Q T U S L P G Y T S Y R
 O E B N F L B G K U H V E L A G M O C I T A S T T
 S S K R V A I Z C K Z M R K V F C R D K H I O E E
 U G E P B W M T U O Y F V O D K Z Y T U G Z K K U
 B D F I D L W J Y I N S A D A D L C B A F S C K S
 M E S U S E J T S I R H C D Q R U V B V Y N Y J S
 I P O Q S Z U D O G J W R O E B I Z G B D C B M F
 T R J D V B F P M T T U L K N K T N E O E E D V J
 P Z T J M P I N S E P D W Q R K M K G U Q B V W S
 V C E Q A J B U D R L S J K Y A O E I L D Z A I G
 Q C J R Z H G O L J E J U L Y T L F K V I B Y L L
 S T R E N G T H E N J D O W D T E K B Z C O G Z T
 Z Q Z I S G Y F T K C H L K T W M S P A M R N F R
 U I Z L H E P L S I V Q E E J L B M P U P P T I A
 A W E L B M U H V K A O S I I A N O U E O J I Z S
 N Z K S M U Y L R P T F P J P P O A Z F E P I T F

CHRIST JESUS
 DEVIL
 ELDERS
 ESTABLISH
 EXALT

FAITH
 GLORY
 GOD
 GRACE
 HUMBLE

HUMILITY
 PERFECT
 PROUD
 RESISTS
 ROARING LION

SETTLE
 STEADFAST
 STRENGTHEN
 SUBMIT
 SUFFERINGS

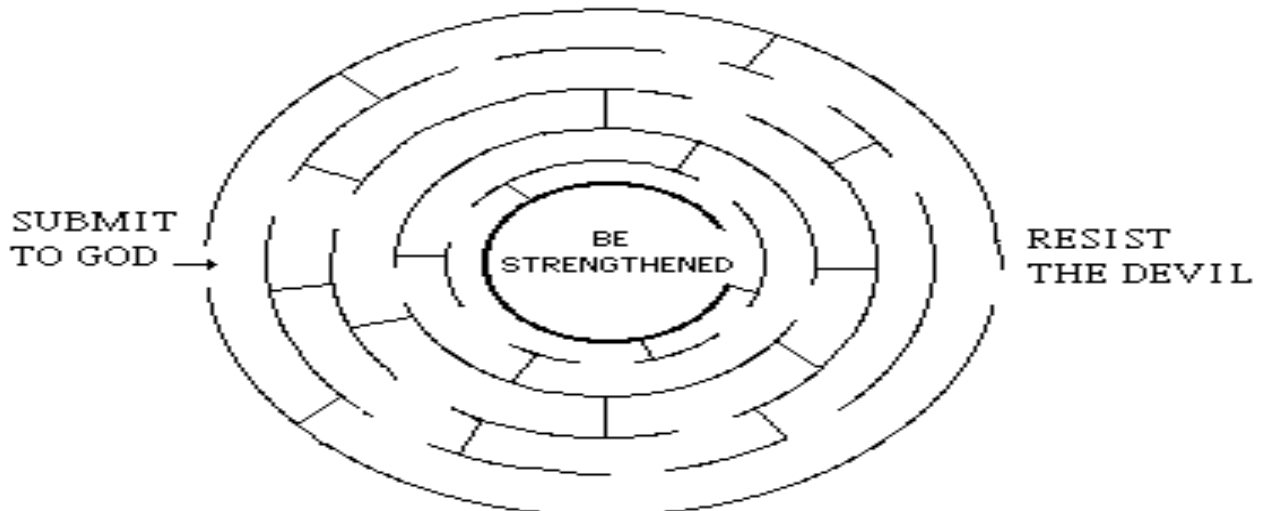

299. Submit To God, Resist the Devil

(1 Peter 5:5-11)

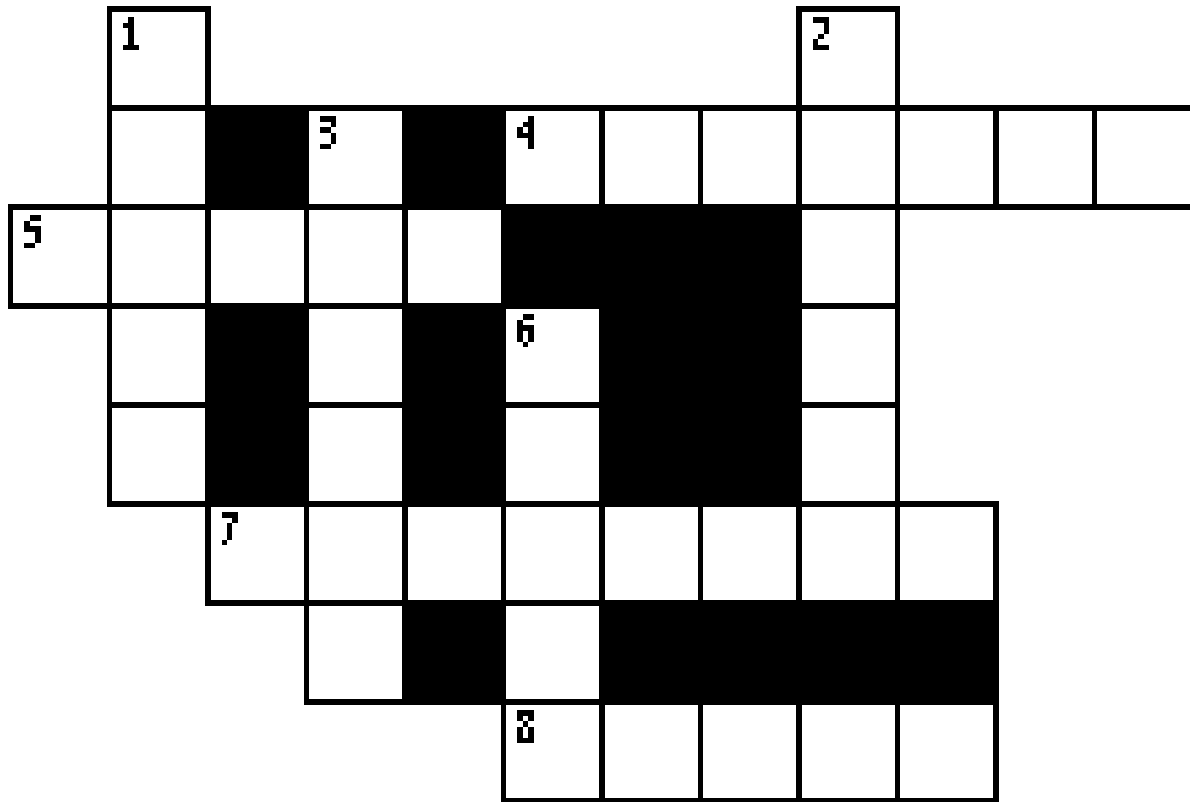

- 7 ACROSS "Likewise you younger people, submit yourselves to your elders. Yes, all of you be submissive to one another, and be clothed with _____." **1 PETER 5:5**
- 1 DOWN "...God resists the proud, But gives _____ to the humble." **1 PETER 5:5**
- 8 ACROSS "Therefore humble yourselves under the mighty hand of God, that He may _____ you in due time." **1 PETER 5:6**
- 5 ACROSS "Casting all your care upon Him, for He _____ for you." **1 PETER 5:7**
- 3 DOWN "Be sober, be vigilant; because your adversary the devil walks about like a roaring lion, seeking whom he may _____." **1 PETER 5:8**
- 2 DOWN "_____ him, steadfast in the faith, knowing that the same sufferings are experienced by your brotherhood in the world." **1 PETER 5:9**
- 6 DOWN "But may the God of all grace, who called us to His eternal glory by Christ Jesus, after you have suffered a _____, perfect, establish, strengthen, and settle you." **1 PETER 5:10**
- 4 ACROSS "To Him be the glory and the dominion _____ and ever. Amen." **1 PETER 5:11**

Bible Story 300

FALSE PROPHETS

2 PETER 2:1-22

300. FALSE PROPHETS

(2 PETER 2:1-22)



"But there were also false prophets among the people,
even as there will be false teachers among you."

2 PETER 2:1

300. FALSE PROPHETS

(2 PETER 2:1-22)

MEMORY VERSE:

"But there were also false prophets among the people, even as there will be false teachers among you." 2 PETER 2:1

CIRCLE THE CORRECT WORDS:

1. "But there were also (**TRUE, FALSE**) prophets among the people, even as there will be (**TRUE, FALSE**) teachers among you, who will secretly bring in destructive heresies, even denying the Lord who bought them, and bring on themselves swift destruction." **2 PETER 2:1**
2. "And (**MANY, FEW**) will follow their destructive ways, because of whom the way of truth will be blasphemed." **2 PETER 2:2**

TRUE OR FALSE:

3. "Then the Lord knows how to deliver the godly out of temptations and to reserve the unjust under punishment for the day of judgment." **2 PETER 2:9**
TRUE OR FALSE
4. "They have forsaken the right way and gone astray, following the way of Balaam the son of Beor, who loved the wages of unrighteousness." **2 PETER 2:15**
TRUE OR FALSE
5. "While they promise them liberty, they themselves are slaves of corruption; for by whom a person is overcome, by him also he is brought into bondage." **2 PETER 2:19**
TRUE OR FALSE

CIRCLE THE CORRECT WORD:

6. "For it would have been (**BETTER, WORSE**) for them not to have known the way of righteousness, than having known it, to turn from the holy commandment delivered to them." **2 PETER 2:21**

300. FALSE PROPHETS

(2 PETER 2:1-22)

J U Y N H M W Q B P L P C Q D
U K O J P F U O K E W T N K W
D O J T J B A M O N G C Q L O
G I F P H E S E I S E R E H L
M T N O I T C U R T S E D W L
E E A L Q T D E S W A G E S O
N L O R D E S W U V J S L K F
T J H J O R J S L E G N A I Q
B S T E H P O R P E S L A F E
B K A C A B R E V O R P K J N
A K G N I Y N E D A U C D S R
C P H V W S H E H R O H D U Y
F A L S E T E A C H E R S E Y
W Z Z T V H S E L F E U O A D
J Y Y W R E V I L E D E K V J

AMONG
ANGELS
BETTER
DELIVER
DENYING

DESTRUCTION
FALSE PROPHETS
FALSE TEACHERS
FLESH
FOLLOW

HERESIES
JUDGMENT
LORD
PROVERB
WAGES



300. FALSE PROPHETS

(2 PETER 2:1-22)

MEMORY VERSE:

"But there were also false prophets among the people, even as there will be false teachers among you." 2 PETER 2:1

FILL IN THE BLANKS:

1. "But there were also _____ prophets among the people, even as there will be _____ teachers among you, who will secretly bring in destructive heresies, even denying the Lord who bought them, and bring on themselves swift destruction." **2 PETER 2:1**
2. "And _____ will follow their destructive ways, because of whom the way of truth will be blasphemed." **2 PETER 2:2**

TRUE OR FALSE:

3. "Then the Lord knows how to deliver the godly out of temptations and to reserve the unjust under punishment for the day of judgment." **2 PETER 2:9**
TRUE OR FALSE
4. "They have forsaken the right way and gone astray, following the way of Balaam the son of Beor, who loved the wages of unrighteousness." **2 PETER 2:15**
TRUE OR FALSE
5. "While they promise them liberty, they themselves are slaves of corruption; for by whom a person _____ is overcome, by him also he is brought into bondage." **2 PETER 2:19**
TRUE OR FALSE

FILL IN THE BLANK:

6. "For it would have been _____ for them not to have known the way of righteousness, than having known it, to turn from the holy commandment delivered to them." **2 PETER 2:21**

300. FALSE PROPHETS

(2 PETER 2:1-22)

T M K I A O Y C F B O H E T W Y T E F K V C R T Z
 B S E I S E R E H B J P W C K D W M K B Z M P I T
 I G Q O Y J P G P A F J E S I D L B S P A P J I M
 A F J T Y J Z R G C A H B C D D A N M P U O P P G
 M H B A O E W G K W H Q K H E J E R O U E E Q G G
 X A W A G E S N B J A O S U N I A L K Z F A X C R
 T J B N F A B G U U H A U E Y P P O G N P Y Q J H
 Y W U N O I T C U R T S E D I T P B A N E U F N U
 L X R D V W M Z K K Z W H C N V A B T V A S G H V
 I P B R G L W J C O Y V P N G R B E M F T T S E Y
 O E K P B M U P A I N M E Q J F V T Z R O H N D Y
 D S E I S Z E N U N J F F L S E Q T J K N A A E R
 E G F Q V B F N M T G S V A U J D E S K I E M B T
 L D J D M P I U T E T E A K L O V R M Y J C M Y E
 I E S R E H C A E T E S L A F S S U B R J N A K U
 V P T J A J B D R O L W R S E U E L P G F A O K S
 E Z E Q Z H G O D J P U L D A G M P C I Y L K J S
 R C J R S G Y F L K L D W D V F C P R K T I E M F
 V C Z I H E P L S K J S J A D K Z B D O H Z C S J
 Q Q Z L M U Y L V P C J M O Q D R M T U P S Y V H
 T E M P T A T I O N S O U K E E L C B A G H U W S
 Z I K S B W B M R Z N H O Q V B U C B V F N E Z G
 U W C T S D D S C G V Q E O N K T V G B Y C D T R
 A Z W O L L O F M Y T O R K R K M Z E O Q Z Y F S
 N K T F V W R Z L Y W P P L Y A O K I U D B G I A

AMONG
 ANGELS
 BETTER
 DARKNESS
 DELIVER
 DENYING

DESTRUCTION
 ENTANGLED
 FALSE PROPHETS
 FALSE TEACHERS
 FLESH
 FOLLOW

HERESIES
 JUDGMENT
 LORD
 PROVERB
 TEMPTATIONS
 WAGES



300. FALSE PROPHETS

(2 PETER 2:1-22)

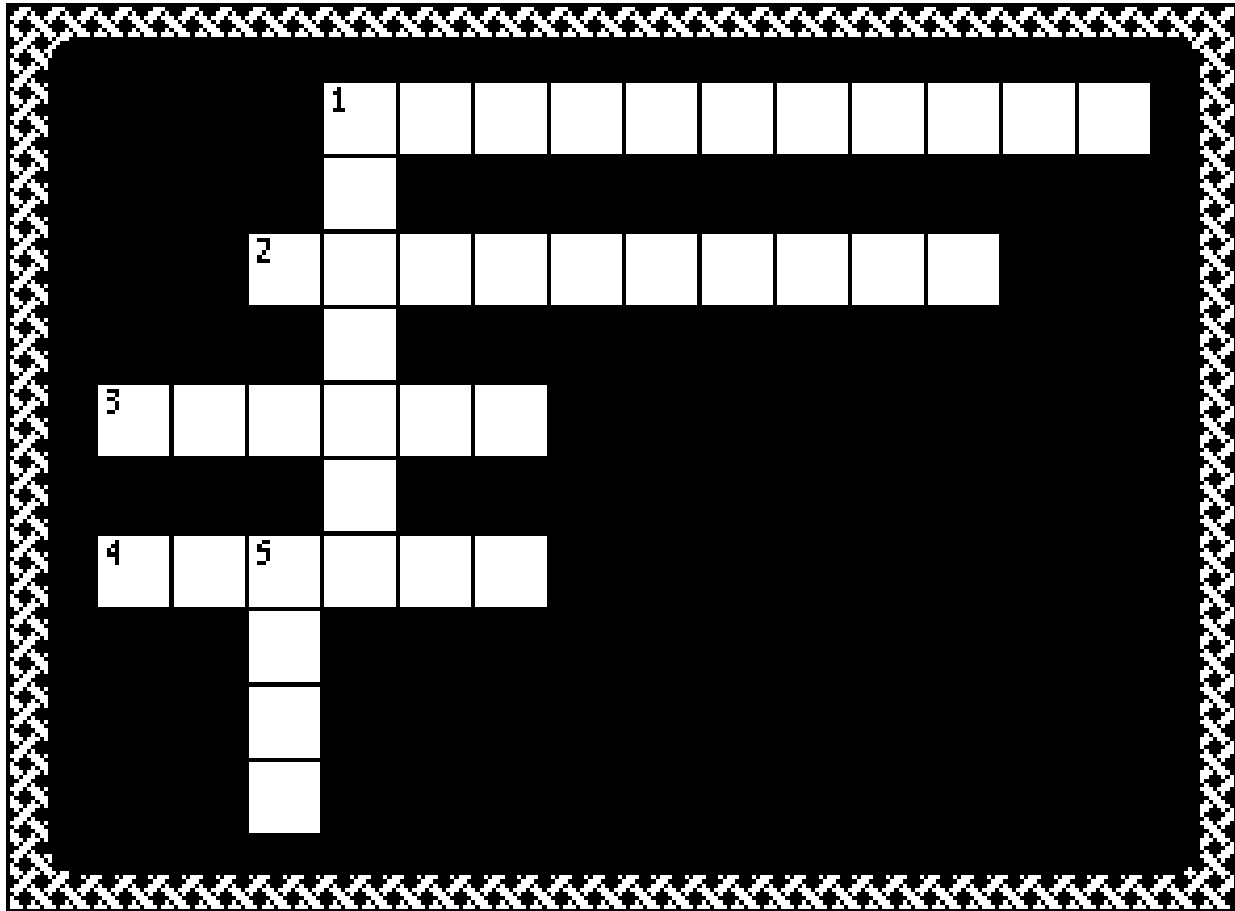

- 1 ACROSS "But there were also false prophets among the people, even as there will be false teachers among you, who will secretly bring in destructive heresies, even denying the Lord who bought them, and bring on themselves swift ____." **2 PETER 2:1**
- 2 ACROSS "And many will follow their destructive ways, because of whom the way of truth will be ____." **2 PETER 2:2**
- 1 DOWN "Then the Lord knows how to ____ the godly out of temptations and to reserve the unjust under punishment for the day of judgment." **2 PETER 2:9**
- 4 ACROSS "They have forsaken the right way and gone ____, following the way of Balaam the son of Beor, who loved the wages of unrighteousness." **2 PETER 2:15**
- 3 ACROSS "While they promise them liberty, they themselves are ____ of corruption; for by whom a person is overcome, by him also he is brought into bondage." **2 PETER 2:19**
- 5 DOWN "For it would have been better for them not to have known the way of righteousness, than having known it, to ____ from the holy commandment delivered to them." **2 PETER 2:21**

Bible Story 301

AS A THIEF IN THE NIGHT

2 PETER 3:10-13

301. AS A THIEF IN THE NIGHT

(2 PETER 3:10-13)



"But the day of the Lord will come as a thief in the night, in which the heavens will pass away with a great noise, and the elements will melt with fervent heat; both the earth and the works that are in it will be burned up."

2 PETER 3:10

301. AS A THIEF IN THE NIGHT

(2 PETER 3:10-13)

MEMORY VERSE:

"But the day of the Lord will come as a thief in the night, in which the heavens will pass away with a great noise, and the elements will melt with fervent heat; both the earth and the works that are in it will be burned up." 2 PETER 3:10

TRUE OR FALSE:

1. "But the day of the Lord will come as a thief in the night..." **2 PETER 3:10**
TRUE OR FALSE
2. "...in which the heavens will pass away with a great noise..." **2 PETER 3:10**
TRUE OR FALSE
3. ...and the elements will freeze with fervent cold... **2 PETER 3:10**
TRUE OR FALSE
4. "...both the earth and the works that are in it will be burned up." **2 PETER 3:10**
TRUE OR FALSE

CIRCLE THE CORRECT WORDS:

5. "Therefore, since all these things will be dissolved, what (**NUMBER, MANNER**) of persons ought you to be in holy conduct and godliness?" **2 PETER 3:11**
6. "Looking for and hastening the coming of the day of God, because of which the (**WATERS, HEAVENS**) will be dissolved being on fire, and the elements will melt with fervent heat?" **2 PETER 3:12**

TRUE OR FALSE:

7. "Nevertheless we, according to His promise, look for new heavens and a new earth in which righteousness dwells." **2 PETER 3:13**
TRUE OR FALSE

301. AS A THIEF IN THE NIGHT

(2 PETER 3:10-13)

G M E D A Y M W L T R J W E I
 O Y E Z G A E J O Q Q E U P E
 D G D L N N E A R T H F I Y S
 L T B N T Y U S D C T S K A I
 I I E S I O N T A E R G E W M
 N R Y F R R S G S K R O W A O
 E I K N I G H T S C O M E S R
 S P K I H T S R F D B A Y S P
 S T C U D N O C Y L O H B A F
 K G J Z U S N O S R E P T P R
 C C S T N E M E L E K G I Q N
 Y J M T V E F A N Y F E I H T
 L O O K I N G F O R I Q O T Y
 U N V M Y D E N R U B F W F M
 D H W G S N E V A E H H A V Z

BURNED
 COME
 DAY
 EARTH
 ELEMENTS
 GODLINESS
 GREAT NOISE

HEAVENS
 HOLY CONDUCT
 LOOKING FOR
 LORD
 MANNER
 MELT
 NEW

NIGHT
 PASS AWAY
 PERSONS
 PROMISE
 THIEF
 WORKS

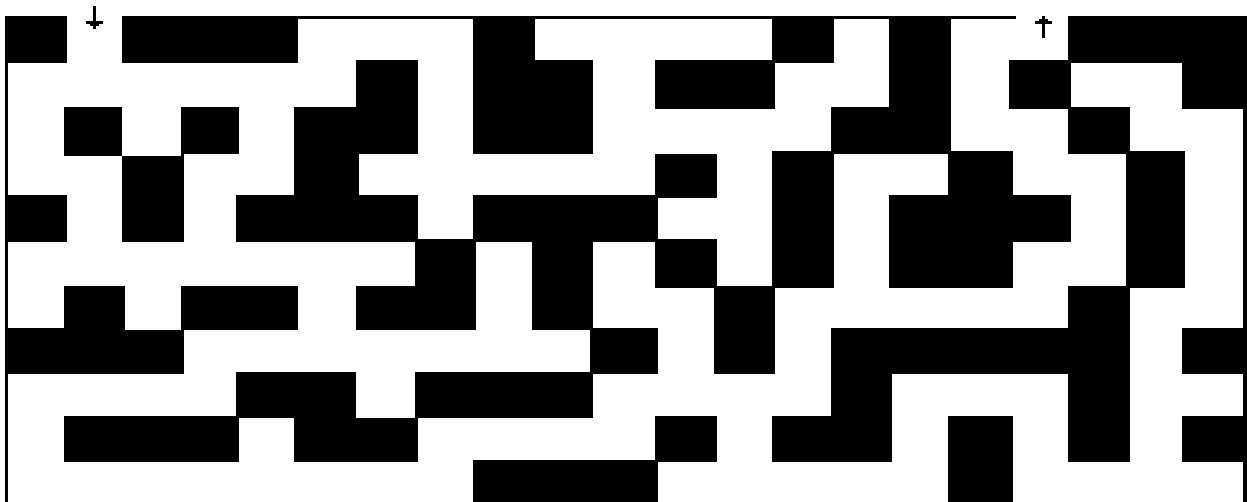

301. AS A THIEF IN THE NIGHT

(2 PETER 3:10-13)

MEMORY VERSE:

"But the day of the Lord will come as a thief in the night, in which the heavens will pass away with a great noise, and the elements will melt with fervent heat; both the earth and the works that are in it will be burned up." 2 PETER 3:10

TRUE OR FALSE:

1. "But the day of the Lord will come as a thief in the night..." **2 PETER 3:10**
TRUE OR FALSE
2. "...in which the heavens will pass away with a great noise..." **2 PETER 3:10**
TRUE OR FALSE
3. ...and the elements will freeze with fervent cold... **2 PETER 3:10**
TRUE OR FALSE
4. "...both the earth and the works that are in it will be burned up." **2 PETER 3:10**
TRUE OR FALSE

FILL IN THE BLANKS:

5. "Therefore, since all these things will be dissolved, what _____ of persons ought you to be in holy conduct and godliness?" **2 PETER 3:11**
6. "Looking for and hastening the coming of the day of God, because of which the _____ will be dissolved being on fire, and the _____ will melt with fervent heat?" **2 PETER 3:12**

TRUE OR FALSE:

7. "Nevertheless we, according to His promise, look for new heavens and a new earth in which righteousness dwells." **2 PETER 3:13**
TRUE OR FALSE

301. AS A THIEF IN THE NIGHT

(2 PETER 3:10-13)

K M B S Z W A Y P Z W Y J W O W O V F B V I P H Z L M U P Z
 Y N Y H I Y Z Y Z P J H J J V H H E I B I V Z C J W Q A F I
 B V L U I Z S M S E V F C H Y J Y N L K W G B H Q B S E I C
 Z S N S D U D B T U H Q B N B S Q J O N A U F L B S P Y A D
 U L D Y Z G G P V V Y B V F C R K A R P M K P U A K B T A B
 F B C J P F P P G F G H D G J V G H D F H J T W M N T N B K
 J M V N Z Y R R W I S S E N I L D O G H L W A A G I H R N L
 U I O D V O C Y D U M M I I N J O N Y H A Y S B B I J G V W
 B O S Y M I V R K H B W O R K S J Y O J Z S A G H C M Q A F
 K B K I A F U E S I U G M E B D M L M C Y F W D P J U A O I
 B K S I N S I B A S V Q O G L U Y W O K E Z I V N H N F W W
 D E L B N T H E A V E N S W L C N M R Z K Z L Z Z M N W E K
 C E D L E N P V G P E N P K O V E C A W G E V Y L U R E T O
 Z Y F O R E N T S K Z U S N D C R N U W Z S U O P J S J E W
 R T A U U M S O A R D W D U N G M R V V S G O O A H C N P F
 D E B P D E C J U E U U O O O O I G W H B K A R K G R Q C U
 Y Z R W W L N Q N E C G F I K E F I A W I Y G C T Q G A V A
 Q Q B C E E P R K T U B U L A Q T K T N E M O C L J W B T H
 Q V E P E B U L S N I W D D U A J H G S W B J U E W K M S O
 H L W R B B C F Y A B D I S W E Q F G R G O D B M L G M B D
 N I G H T L E P B I Q I V U K G O F Z I B L E R W Q Q J Q B
 F S G F D I B V F H T R A E Y R E T V V R F Q B O P N L B K
 O S F M H A C G L P B C E J Y A P S K B T W W P Y W G F M S
 I R N T V E B Y K Q V P M L E T G T B K D U D I K E H Z I L
 H S Z O N Z P Q I E S I O N T A E R G G P U U Y Z T W A T Z
 H B A E S C R D Q F B L N J H N G O M P T Y A V U F Z P N I
 Q B N T P R E O S R W O B T L B L Y S E C O B N M O G M B C
 U Z N L Y L E O S C Y P A B B K Y T H I P L C W P R V B P D
 F F E M G W M P O G U D S V R L T T J N N P Q E G U K R Y C
 U W W E N C H K E O K Q P Q O D P G L A B Z K H K A C Z P Q

BURNED UP
 COME
 DAY
 EARTH
 ELEMENTS
 GODLINESS

GREAT NOISE
 HEAVENS
 HOLY CONDUCT
 LOOKING FOR
 LORD

MANNER
 MELT
 NEW
 NIGHT
 PASS AWAY

PERSONS
 PROMISE
 RIGHTEOUSNESS
 THIEF
 WORKS

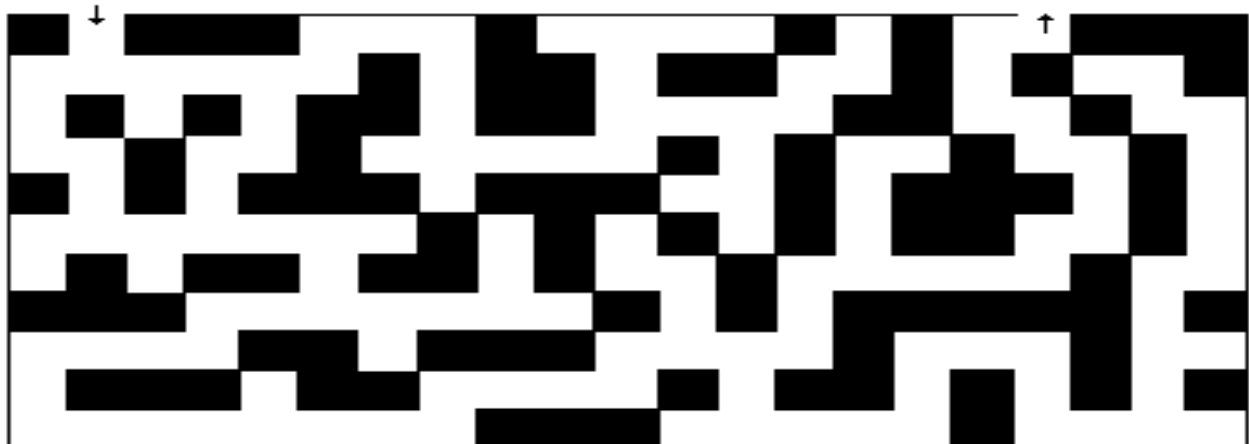

301. AS A THIEF IN THE NIGHT

(2 PETER 3:10-13)

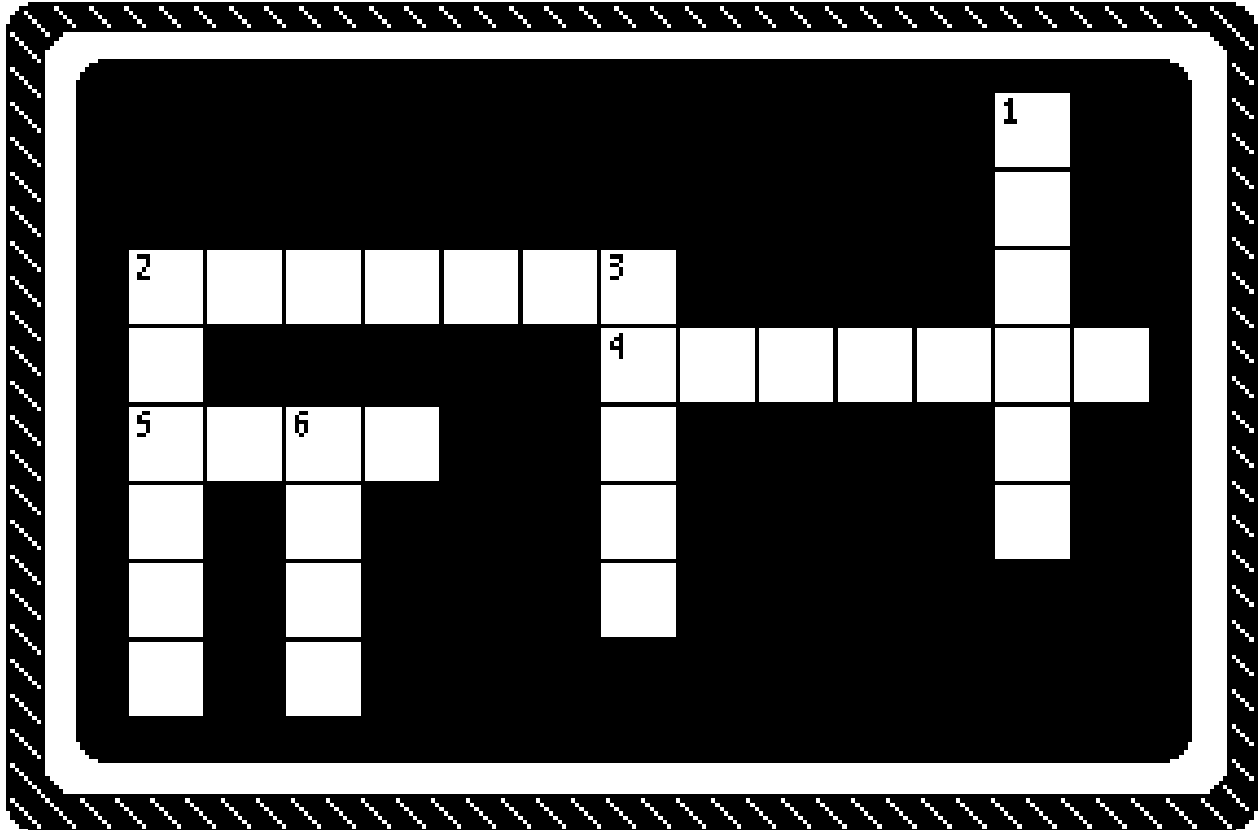

- 3 DOWN "But the day of the Lord will come as a _____ in the night..." **2 PETER 3:10**
- 4 ACROSS "...in which the _____ will pass away with a great noise..." **2 PETER 3:10**
- 5 ACROSS "...and the elements will _____ with fervent heat..." **2 PETER 3:10**
- 1 DOWN "...both the earth and the works that are in it will be _____ up." **2 PETER 3:10**
- 2 ACROSS "Therefore, since all these things will be dissolved, what manner of persons ought you to be in holy _____ and godliness?" **2 PETER 3:11**
- 2 DOWN "Looking for and hastening the _____ of the day of God, because of which the heavens will be dissolved being on fire, and the elements will melt with fervent heat?" **2 PETER 3:12**
- 6 DOWN "Nevertheless we, according to His promise, _____ for new heavens and a new earth in which righteousness dwells." **2 PETER 3:13**

Bible Story 302

WALKING IN THE LIGHT

1 JOHN 1:5-10



"Walking in the Light"
1John 1:5-10

302. WALKING IN THE LIGHT

(1 JOHN 1:5-10)

MEMORY VERSE:

"But if we walk in the light as He is in the light, we have fellowship with one another, and the blood of Jesus Christ His Son cleanses us from all sin." 1 JOHN 1:7

TRUE OR FALSE:

1. "This is the message which we have heard from Him and declare to you, that God is light and in Him is no darkness at all." **1 JOHN 1:5**

TRUE OR FALSE

CIRCLE THE CORRECT WORD:

2. "If we say that we have fellowship with Him, and walk in (**DARKNESS, CIRCLES**), we lie and do not practice the truth." **1 JOHN 1:6**

TRUE OR FALSE:

3. "But if we walk in the light as He is in the light, we have fellowship with one another, and the blood of Jesus Christ His Son cleanses us from all sin." **1 JOHN 1:7**

TRUE OR FALSE

CIRCLE THE CORRECT WORD(S):

4. "If we say that we have no sin, the truth (**IS, IS NOT**) in us." **1 JOHN 1:8**

TRUE OR FALSE:

5. "If we confess our sins, He is faithful and just to forgive us our sins and to cleanse us from all unrighteousness." **1 JOHN 1:9**

TRUE OR FALSE

302. WALKING IN THE LIGHT

(1 JOHN 1:5-10)

W E V I G R O F Z M C D J J O
V A W U S F R P F D R T S U J
B H L W S I C N P O W P F C A
S M L K E B G U W L J Z A V W
V B L U F H T I A F T R U T H
M S Z D N G R O G S U Y H T V
B V B W O Y G F K V K Y A W R
L O P Y C P N L B R O O H H A
O P I H S W O L L E F E Z G I
O J J P S U S E J C I R Y O L
D J H Z M Y S L U M T A N D M
A E G W W B G I K L E L J P F
C L E A N S E S N B J C T J S
Z A E B I D Z M C B K E P H W
S T H G I L J S U A K D L Q U

BLOOD
CLEANSES
CONFESS
DECLARE
FAITHFUL
FELLOWSHIP

FORGIVE
GOD
JESUS
JUST
LIAR

LIGHT
SIN
TRUTH
WALK
WORD



302. WALKING IN THE LIGHT

(1 JOHN 1:5-10)

MEMORY VERSE:

"But if we walk in the light as He is in the light, we have fellowship with one another, and the blood of Jesus Christ His Son cleanses us from all sin." 1 JOHN 1:7

TRUE OR FALSE:

1. "This is the message which we have heard from Him and declare to you, that God is light and in Him is no darkness at all." **1 JOHN 1:5**

TRUE OR FALSE

FILL IN THE BLANK:

2. "If we say that we have fellowship with Him, and walk in _____, we lie and do not practice the truth." **1 JOHN 1:6**

TRUE OR FALSE:

3. "But if we walk in the light as He is in the light, we have fellowship with one another, and the blood of Jesus Christ His Son cleanses us from all sin." **1 JOHN 1:7**

TRUE OR FALSE

FILL IN THE BLANK:

4. "If we say that we have no sin, the _____ is not in us." **1 JOHN 1:8**

TRUE OR FALSE:

5. "If we confess our sins, He is faithful and just to forgive us our sins and to cleanse us from all unrighteousness." **1 JOHN 1:9**

TRUE OR FALSE

302. WALKING IN THE LIGHT

(1 JOHN 1:5-10)

T M K T S H G Y O V P T O T I I A N T F O Q Z Y Z
B S S E F N O C F R L W E C J P P O M R U D B G T
I G Q I T M E P L I Z H W S S F P B Z K V C R T M
A F J O F B U Y A C Y P E C F S A U J K Z M P I G
M H B T A S W R L M Y J B H O T E I S Y A P J I G
B A W O R D D B M L O H K U R V A S T R U O P P R
T D B A Y V W D S B J Q S E G R B L N H E E Q G H
Y W E T S I R H C S U S E J I F V P M A F A B C U
L B R C Y O Y R Z B F O U C V E Q J B G E U Q J V
I P B N L J P H F A A A H N E J D U P I F L L N Y
O E K R E A T C P C H W P Q U O V S C B P Y C H Y
D S E I O U R G G W A V E L E U S T D U T U F E R
E G L P R J Z E K J H M V K A G M M T A O H G D T
C D F T F E W R B U Z F A D V B C C B V N A A B E
E E S S E N S U O E T H G I R N U C B S I E M Y U
I P J I V A B D O G Y S R D D K Z V G S S C M K S
V Z T Q B W M G U K N W L O Q D L Z E E L I A K S
E C E D S L W N K O J U W K E B U K I N J I N J F
V C J J V Z U G C I T D J Q N K T E K K J N G M J
Q Q Z Q M B F Z U T P S U K R K G F B R Y A O H S
W A L K F E L L O W S H I P Y A M K P A T I K V T
Z I Z R A P I J M E L J O L S A O S P D H Z C W G
U W K I Z J B P D J J H E S Y T E M U O G S Y Z R
A Z D O O L B N L K C Q E W D W M O Z N F N U F A
N K C L S H G U S K V M P K J L B A V X Y C D I S

BLOOD
CLEANSES
CONFESS
DECEIVE
DECLARE
FAITHFUL
FORGIVE

GOD
JESUS CHRIST
JUST
LIAR
LIE
LIGHT
MESSAGE

NO DARKNESS
SIN
TRUTH
UNRIGHTEOUSNESS
WALK
WORD
FELLOWSHIP



302. WALKING IN THE LIGHT

(1 JOHN 1:5-10)

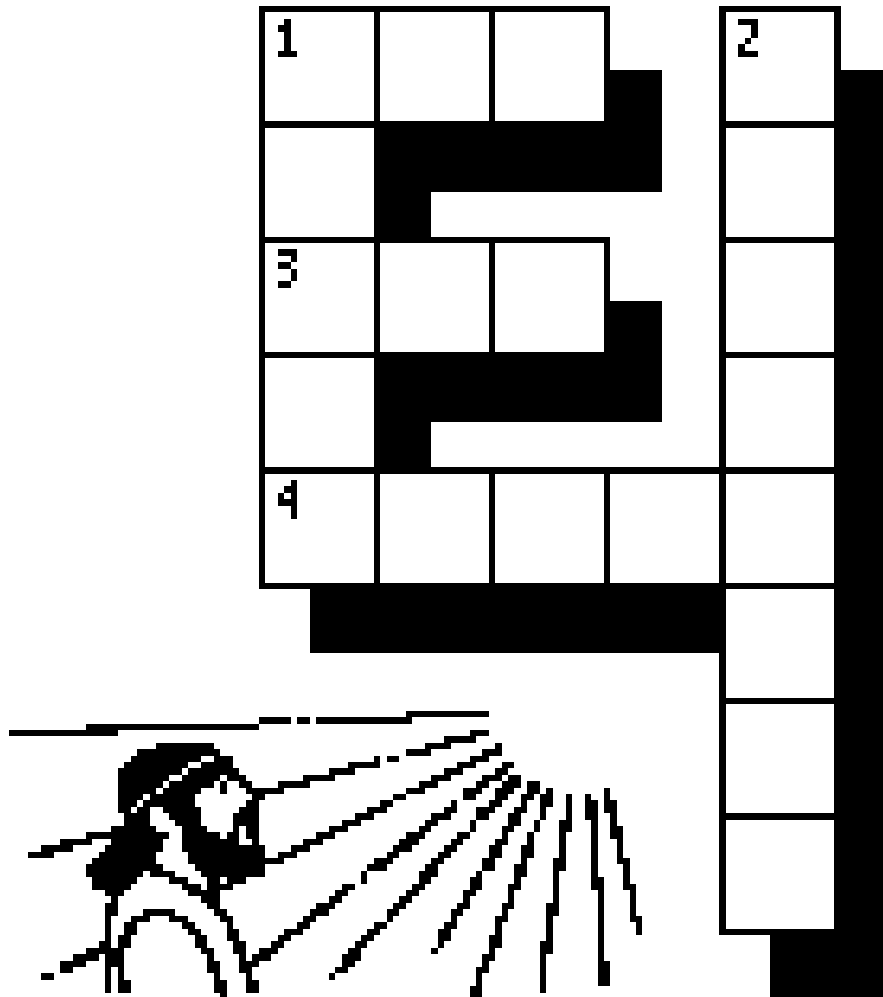

- 3 ACROSS "This is the message which we have heard from Him and declare to you, that _____ is light and in Him is no darkness at all." **1 JOHN 1:5**
- 1 ACROSS "If we say that we have fellowship with Him, and walk in darkness, we _____ and do not practice the truth." **1 JOHN 1:6**
- 1 DOWN "But if we walk in the _____ as He is in the light, we have fellowship with one another, and the blood of Jesus Christ His Son cleanses us from all sin." **1 JOHN 1:7**
- 4 ACROSS "If we say that we have no sin, the _____ is not in us." **1 JOHN 1:8**
- 2 DOWN "If we confess our sins, He is _____ and just to forgive us our sins and to cleanse us from all unrighteousness." **1 JOHN 1:9**

Bible Story 303

LET US LOVE ONE ANOTHER

1 JOHN 4:7-16

303. LET US LOVE ONE ANOTHER

(1 JOHN 4:7-16)



"Beloved, let us love one another, for love is of God;
and everyone who loves is born of God and knows God."

1 JOHN 4:7

303. LET US LOVE ONE ANOTHER

(1 JOHN 4:7-16)

MEMORY VERSE:

"Beloved, let us love one another, for love is of God; and everyone who loves is born of God and knows God." 1 JOHN 4:7

CIRCLE THE CORRECT WORD:

1. "Beloved, let us (**LOVE, HATE**) one another, for love is of God; and everyone who loves is born of God and knows God." **1 JOHN 4:7**

TRUE OR FALSE:

2. "He who does not love does not know God, for God is love." **1 JOHN 4:8**
TRUE OR FALSE

CIRCLE THE CORRECT WORD:

3. "In this the love of God was manifested toward us, that God has sent His only begotten Son into the world, that we might (**LIVE, SEE**) through Him." **1 JOHN 4:9**

TRUE OR FALSE:

4. Beloved, if God so loved us, we do not need to love one another. **1 JOHN 4:11**
TRUE OR FALSE

5. "And we have seen and testify that the Father has sent the Son as Savior of the world."
1 JOHN 4:14
TRUE OR FALSE

6. "Whoever confesses that Jesus is the Son of God, God abides in him, and he in God."
1 JOHN 4:15
TRUE OR FALSE

CIRCLE THE CORRECT WORD

7. "God is love, and he who abides in (**LOVE, SELFISHNESS**) abides in God, and God in him."
1 JOHN 4:16

303. LET US LOVE ONE ANOTHER

(1 JOHN 4:7-16)

S T I R I P S S W W U R N S L
E I B Z R Q Y H L F F C G Z S
E W D Z O D Y M Z S A G Z F V
N O K K I J O B D D E T J P R
G Z D E V O L E B L I D H G C
Z K E C A Q F S B W R R I E M
K K F T S R V V P Y B O P B R
N Q J I N I B E V O L G W K A
O R E H T O N A E N O Y N B L
W J T O R L S O J P G F B B B
S B N O S S V J H Z Y I O W B
C B E T P T M J G W P T F C N
C O N F E S S E S B Y S L B R
C R J A I F A E E M B E L M O
Q E V I L A Z A U W D T M D B

ABIDES
BELOVED
BORN
CONFESSES
FATHER
GOD

KNOWS
LIVE
LOVE
ONE ANOTHER
SAVIOR

SEEN
SON
SPIRIT
TESTIFY
WORLD

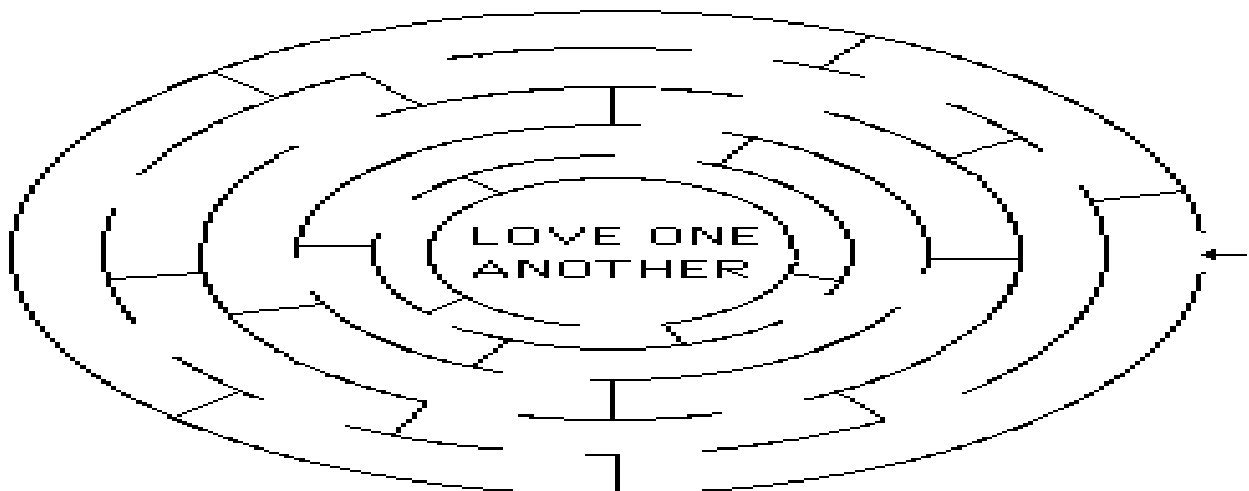

303. LET US LOVE ONE ANOTHER

(1 JOHN 4:7-16)

MEMORY VERSE:

"Beloved, let us love one another, for love is of God; and everyone who loves is born of God and knows God." 1 JOHN 4:7

FILL IN THE BLANK:

1. "Beloved, let us _____ one another, for love is of God; and everyone who loves is born of God and knows God." **1 JOHN 4:7**

TRUE OR FALSE:

2. "He who does not love does not know God, for God is love." **1 JOHN 4:8**
TRUE OR FALSE

FILL IN THE BLANK:

3. "In this the love of God was manifested toward us, that God has sent His only begotten Son into the world, that we might _____ through Him." **1 JOHN 4:9**

TRUE OR FALSE:

4. Beloved, if God so loved us, we do not need to love one another. **1 JOHN 4:11**
TRUE OR FALSE

5. "And we have seen and testify that the Father has sent the Son as Savior of the world."
1 JOHN 4:14

TRUE OR FALSE

6. "Whoever confesses that Jesus is the Son of God, God abides in him, and he in God."
1 JOHN 4:15

TRUE OR FALSE

FILL IN THE BLANKS:

7. "God is love, and he who _____ in love _____ in God, and God in him."
1 JOHN 4:16

303. LET US LOVE ONE ANOTHER

(1 JOHN 4:7-16)

S B W M J D L O T N W B W G E O L W A H
P O H F W R B N D Q P B A C M A Y Q D J
M S Q M Y A R H D B E L O V E D H N Y Y
B L S Q O Z Z E Q B N P F Z Q K B I S K
B K I W J N Z I H N K P U D L R O W M P
O W L S O E E U C T B Y T H S E D I B A
H V H Q T N N A B A A F O K N U O S B G
S J T V N M K A N Y G F M K Y Y I V B K
S B Y L O V E F J O C O J R R F R U S G
R W O P B D B F B Q T O D O M I F U E P
V S A B A O O T S U D H I E A T Y A J S
N E P Q S C R Q M Q W V E N S S X D M O
G L V I L W O N J T A J K R V E D D G T
D V C J R Q B N T S K W G C Y T F W O W
P D A I N I H H F H I S H V K N B T V I
K D L O P B T A A E E S G C W U E L S H
S Z S C U E F U A T S I D C L D H A P J
P Z O T T I V U U T P S V H W L T O T D
P S E E N T V I E R I A E R W U L A W U
R O Z C N A I T L R Y G B S Z F U P B O

ABIDES
BELOVED
BORN
CONFESSES
FATHER
GOD

KNOWS
LIVE
LOVE
ONE ANOTHER
SAVIOR

SEEN
SON
SPIRIT
TESTIFY
WORLD

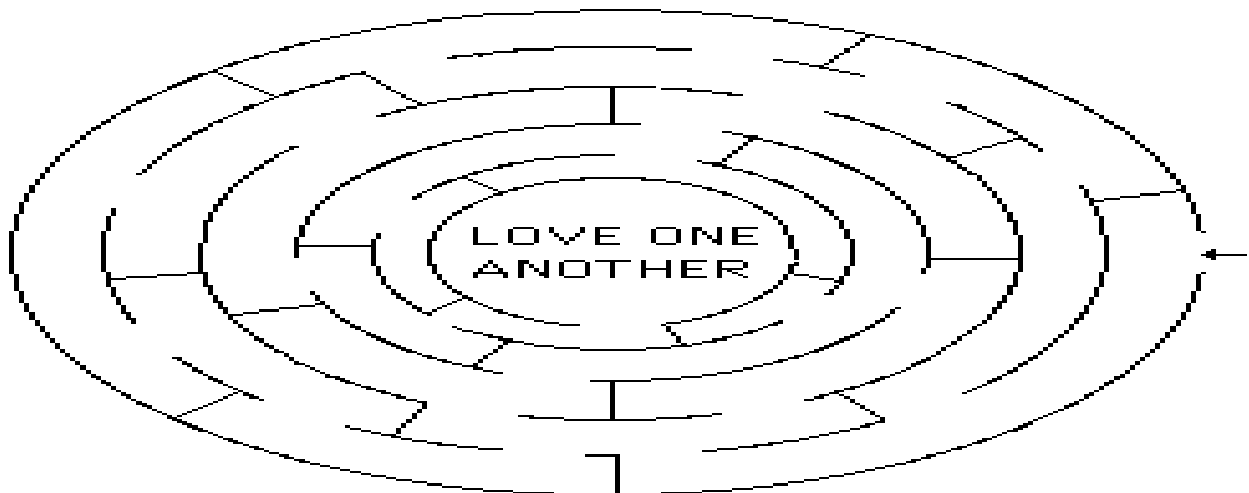

303. LET US LOVE ONE ANOTHER

(1 JOHN 4:7-16)

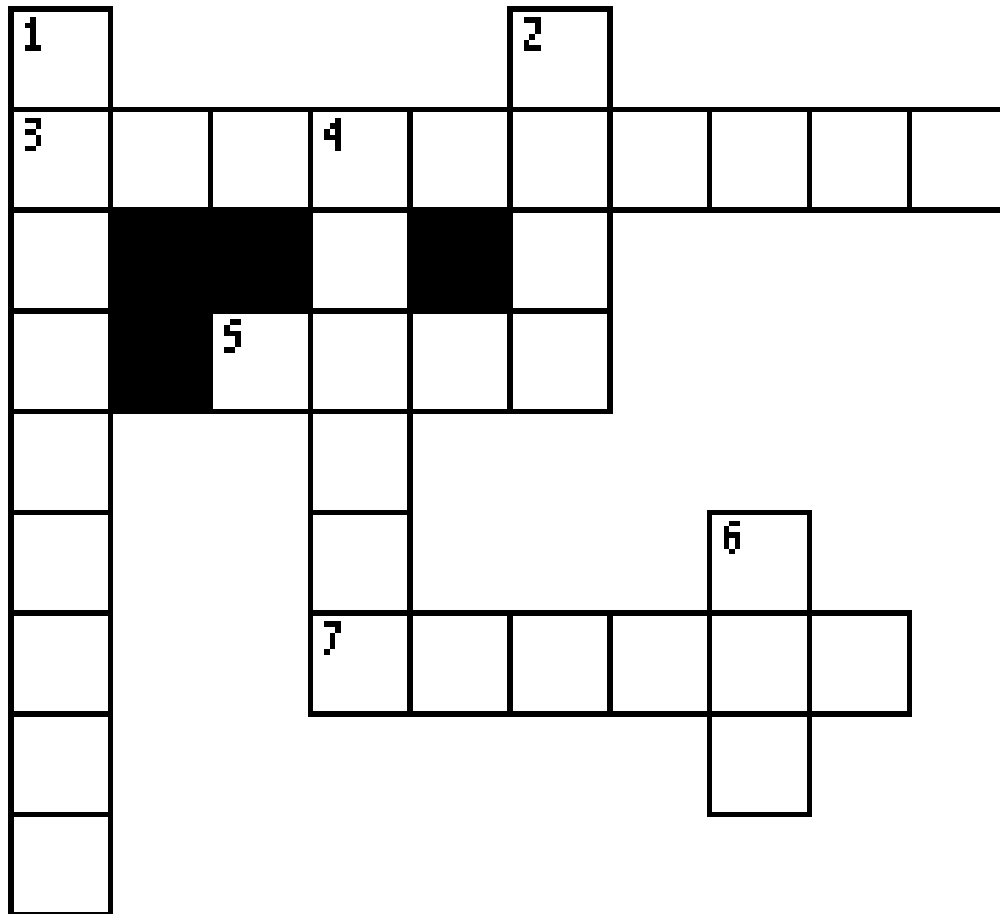

- 2 DOWN "Beloved, let us _____ one another, for love is of God; and everyone who loves is born of God and knows God." **1 JOHN 4:7**

- 6 DOWN "He who does not love does not know God, for _____ is love." **1 JOHN 4:8**

- 5 ACROSS "In this the love of God was manifested toward us, that God has sent His only begotten Son into the world, that we might _____ through Him." **1 JOHN 4:9**

- 3 ACROSS "Beloved, if God so loved us, we also ought to love _____ _____." **1 JOHN 4:11**

- 7 ACROSS "And we have seen and testify that the Father has sent the Son as _____ of the world." **1 JOHN 4:14**

- 1 DOWN "Whoever _____ that Jesus is the Son of God, God abides in him, and he in God." **1 JOHN 4:15**

- 4 DOWN "God is love, and he who abides in love _____ in God, and God in him." **1 JOHN 4:16**

Bible Story 304

**JOHN HEARS
THE VOICE
AS OF A TRUMPET**

Revelation 1:9-19

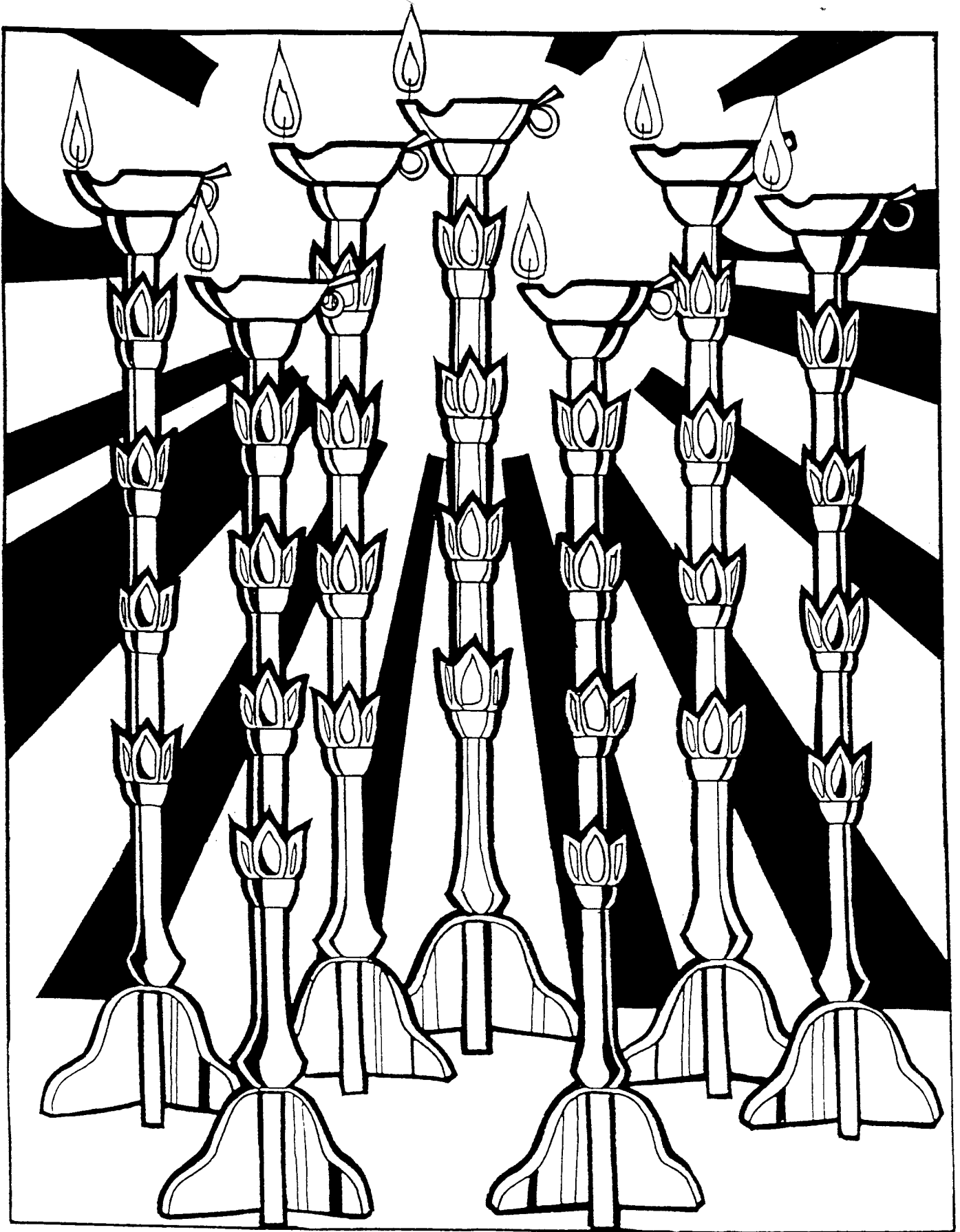

John sees the seven golden lampstands which are the seven churches.
REVELATION 1:12,13,20

304. JOHN HEARS THE VOICE AS OF A TRUMPET

(REVELATION 1:9-19)

MEMORY VERSE:

"I am He who lives, and was dead, and behold, I am alive forevermore."

REVELATION 1:18

John writes...

CIRCLE THE CORRECT WORDS:

1. "I was in the Spirit on the Lord's Day, and I heard behind me a loud voice, as of a **(CRUMPET, TRUMPET)**." **REVELATION 1:10**

2. "...saying, 'I am the Alpha and the Omega, the First and the Last,' and, 'What you see, write in a book and send it to the seven **(CHURCHES, STORES)** which are in Asia: to Ephesus, to Smyrna, to Pergamos, to Thyatira, to Sardis, to Philadelphia, and to Laodicea.'" **REVELATION 1:11**

3. "Then I turned to see the voice that spoke with me. And having turned I saw seven golden **(RINGS, LAMPSTANDS)**." **REVELATION 1:12**

TRUE OR FALSE:

- | | | |
|---|-----|---------------|
| 4. "...and in the midst of the seven lampstands One like the Son of Man, clothed with..." | | T or F |
| REVELATION 1:13-16 | | |
| a garment down to the feet | v13 | _____ |
| His chest was girded with a golden band | v13 | _____ |
| His head and His hair were white like wool, as white as snow | v14 | _____ |
| His eyes were like a flame of fire | v14 | _____ |
| His feet were like fine gold | v15 | _____ |
| His voice as the sound of many waters | v15 | _____ |
| In His right hand He had seven rainbows | v16 | _____ |
| Out of His mouth went a sharp two-edged sword | v16 | _____ |
| His countenance was like the sun shining in its strength | v16 | _____ |

CIRCLE THE CORRECT WORD:

5. "And when I saw Him, I fell at His feet as dead. But He laid His right hand on me, saying to me, 'Do not be **(AFRAID, AWAKE)**; I am the First and Last.'" **REVELATION 1:17**

304. JOHN HEARS THE VOICE AS OF A TRUMPET

(REVELATION 1:9-19)

S D S W C O L A N T O A Q O U
O S U J M K W V Y H U T D E A
N J H E H D K D Y V O W V Y H
O H G U U D I Q D R G J S A P
F A S D N A T S P M A L M D L
M Q P O E O J E J F F L C S A
A O E E C K V O I C E A Z D L
N E V P N Q S T S R I F L R P
V T S I R H C S U S E J U O M
M W A T Q T E P M U R T T L C
F E S E H C R U H C B P T M C
S W R I T E U N I E D P S B V
R E V E L A T I O N B A A N Z
W B R C L K E R P J K B L O K
U K L S T I R I P S K V M B F

ALPHA
CHURCHES
FIRST
JESUS CHRIST
JOHN

LAMPSTANDS
LAST
LORD'S DAY
OMEGA
REVELATION

SON OF MAN
SPIRIT
TRUMPET
VOICE
WRITE

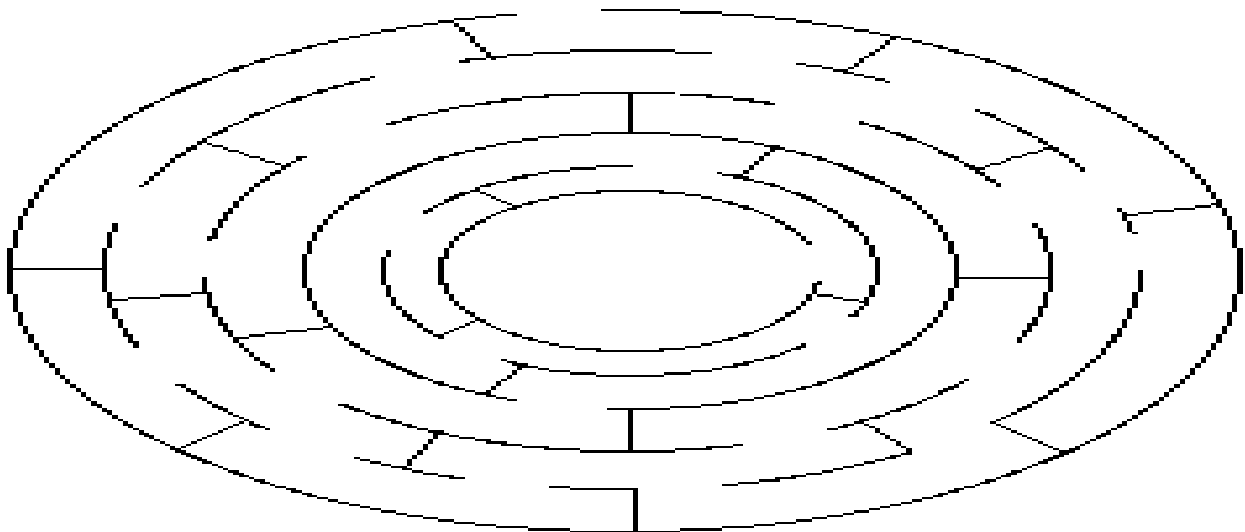

304. JOHN HEARS THE VOICE AS OF A TRUMPET (REVELATION 1:9-19)

MEMORY VERSE:

"I am He who lives, and was dead, and behold, I am alive forevermore."

REVELATION 1:18

John writes...

FILL IN THE BLANKS:

1. "I was in the Spirit on the Lord's Day, and I heard behind me a loud voice, as of a _____." **REVELATION 1:10**

2. "...saying, 'I am the Alpha and the Omega, the First and the Last,' and, 'What you see, write in a book and send it to the seven _____ which are in Asia: to Ephesus, to Smyrna, to Pergamos, to Thyatira, to Sardis, to Philadelphia, and to Laodicea.'" **REVELATION 1:11**

3. "Then I turned to see the voice that spoke with me. And having turned I saw seven golden _____." **REVELATION 1:12**

TRUE OR FALSE:

- | | | | |
|----|--|-----|---------------|
| 4. | "...and in the midst of the seven lampstands One like the Son of Man, clothed with..." | | T or F |
| | REVELATION 1:13-16 | | |
| | a garment down to the feet | v13 | _____ |
| | His chest was girded with a golden band | v13 | _____ |
| | His head and His hair were white like wool, as white as snow | v14 | _____ |
| | His eyes were like a flame of fire | v14 | _____ |
| | His feet were like fine gold | v15 | _____ |
| | His voice as the sound of many waters | v15 | _____ |
| | In His right hand He had seven rainbows | v16 | _____ |
| | Out of His mouth went a sharp two-edged sword | v16 | _____ |
| | His countenance was like the sun shining in its strength | v16 | _____ |

FILL IN THE BLANKS:

5. "And when I saw Him, I fell at His feet as dead. But He laid His right hand on me, saying to me, 'Do not be afraid; I am the _____ and _____.'" **REVELATION 1:17**

304. JOHN HEARS THE VOICE AS OF A TRUMPET

(REVELATION 1:9-19)

B L L P F K W S C W B A G I T K F U V J Y T H L R I K Z B Q
 K K O U V S P I Z L D P K U P M B O L K U K D P S V M U A H
 K W Z T I M N A H W F A G M L L B Z A U W N C O M S I I D C
 O V M N T J K G K S W D P R E V E L A T I O N L C M U J P C
 J J F S O T G W K A E Y S F J U K B I M I B U T U K B L U N
 Q B R E N A B O T W B H O O B G M A L B A Y U P R I W M K U
 S I M D C A C E L Z E S C E J W R I T E E T I H W R V P I K
 F W Q R H I R A R D H M T R H C Z M R Y C Z S N A H P L A S
 P E S A I S O F E O E U W P U V B Z U R L Y A D S D R O L U
 M L Q Z U U D V N A T N I K T H I B U T P A Y R S K K B B N
 B V V E A E W U C K L B L J J U C T C T A B J A J Q G E R E
 B D P M F N K T V U U S H A Y B Z P Q C I U G E L Y P C Q S
 O D B D F Q I O C N W E T F M N F Z N M E E A C P C H H I B
 H Z Q W T B R A S S Q J J E R P Z F R P Y D K N B Z K M J T
 S Z J Q Q B E D C U N M D Y P H S V S M A K R A N A H B L I
 S O I B H N P R H D I G U T D M B T U R Q G B N S K C I J L
 R W S I A A I O J L S O O W C B U F A L A C N E L R O V V E
 V H C P U Y Y W R E V V L U G A D R K N A T Y T P V V M R I
 N Q T T I Q B S E U S S O G S U K H T C D M S N H Z N T R A
 G I C A U R B M M F U U U H Q V B N B S O S N U L Y J Q K K
 D L J L T U I J Q L U P S S O M T A P N Y N M O Q Q E L V J Q
 P H W B T Q P T N Y A T I C U A U E I A E Q Q C U H D U S Y
 K T Y Z D T S K Y H D W I B H E Y E F M A R P P I Z R G F R
 S Y J Z D A P G M B D B B V M R E M W F E U L L C C Z B Q B
 P O T N L H Y H N O W H R S J I I J L O Q M J Y C S B D V T
 P A N K Q T F G A H T J W U Q S E S J N U E D M M G Y O B P
 R V A O C T O D S I O Y G B L G J Q T O T S D T R I A N R K
 B O M E G A J V V R L J T H J J A V B S V Z R F B F E Z B Z
 O C S B U R W B Y F A K K U T P V E B G S P M H G L M F I O
 S A L H J R S G K Y O P W Q W Z K V K E E J J D B B B N U V

ALPHA
 BRASS
 CHURCHES
 COUNTENANCE
 FIRST
 GOLDEN LAMPSTANDS

JESUS CHRIST
 JOHN
 LAST
 LORD'S DAY
 OMEGA
 PATMOS

REVELATION
 SON OF MAN
 SPIRIT
 STARS
 SWORD

TRUMPET
 VOICE
 WATERS
 WHITE
 WRITE

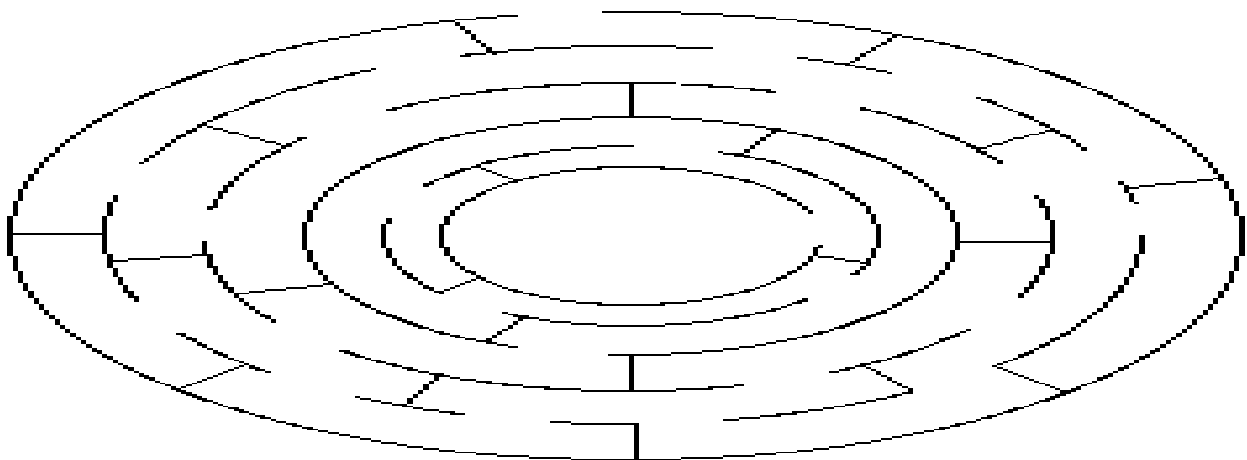

304. JOHN HEARS THE VOICE AS OF A TRUMPET

(REVELATION 1:9-19)

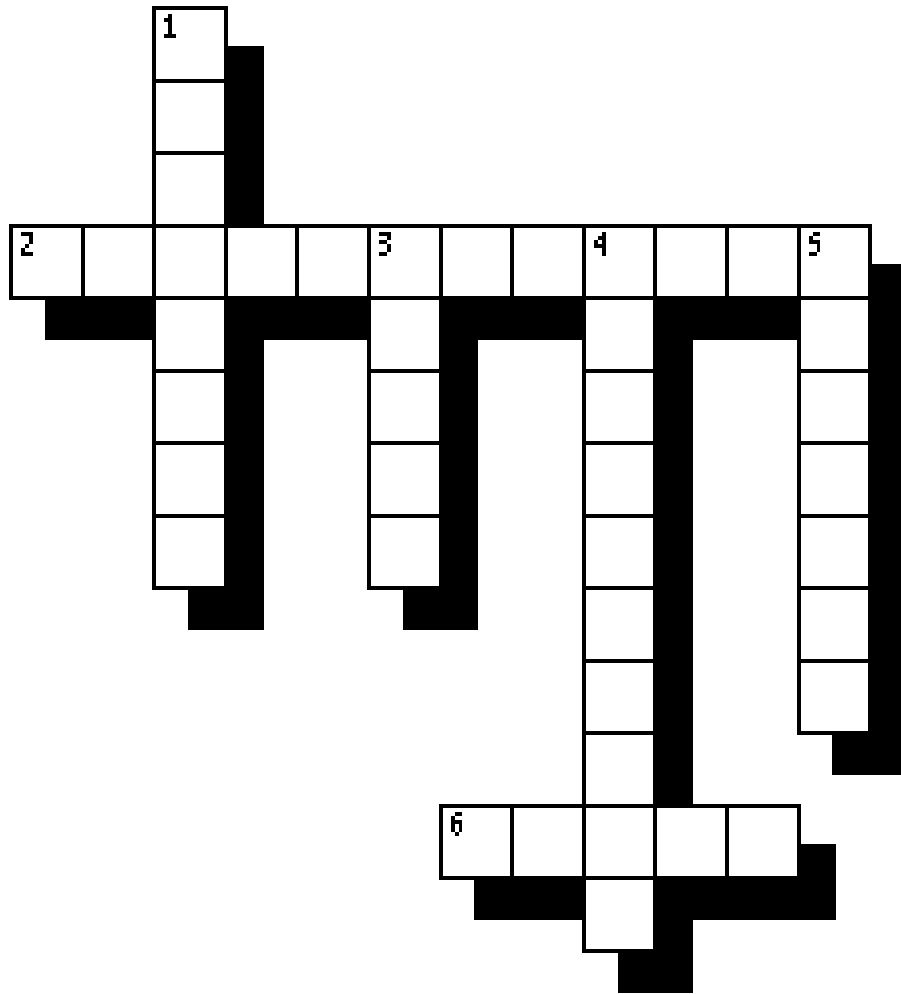

- 5 DOWN "I was in the Spirit on the Lord's Day, and I heard behind me a loud voice, as of a ____."
REVELATION 1:10
- 1 DOWN "...saying, 'I am the Alpha and the Omega, the First and the Last,' and, 'What you see, write in a book and send it to the seven ____ which are in Asia: to Ephesus, to Smyrna, to Pergamos, to Thyatira, to Sardis, to Philadelphia, and to Laodicea.' "**REVELATION 1:11**
- 4 DOWN "Then I turned to see the voice that spoke with me. And having turned I saw seven golden ____."
REVELATION 1:12
- 6 ACROSS "...and in the ____ of the seven lampstands One like the Son of Man..." **REVELATION 1:13**
- 2 ACROSS "And when I saw Him, I fell at His feet as dead. But He laid His right hand on me, saying to me, 'Do not be afraid; I am the ____ ____ ____.'" **REVELATION 1:17**
- 3 DOWN "I am He who lives, and was dead, and behold, I am ____ forevermore." **REVELATION 1:18**

Bible Story 305

**THE
SEVEN CHURCHES**

Revelation 1:20-3:22



Jesus said, "Behold, I stand at the door and knock.
If anyone hears My voice and opens the door, I will come in to him and dine with him, and he with Me."
REVELATION 3:20

305. THE SEVEN CHURCHES

(REVELATION 1:20-3:22)

MEMORY VERSE:

"Behold, I stand at the door and knock. If anyone hears My voice and opens the door, I will come in to him and dine with him, and he with Me." REVELATION 3:20

Jesus said to John...

TRUE OR FALSE:

1. "To the angel of the church of Ephesus write..." "I know your works, your labor, your patience, and that you cannot bear those who are evil..." **REVELATION 2:2** "Nevertheless I have this against you, that you have left your first love." **REVELATION 2:4**

TRUE OR FALSE

2. "To the angel of the church in Smyrna write..." "I know your works, tribulation, and poverty (but you are rich)..." **REVELATION 2:9** "...Be faithful until death, and I will give you the crown of life." **REVELATION 2:10**

TRUE OR FALSE

CIRCLE THE CORRECT WORDS:

3. "To the angel of the church in Pergamos write..." "I know your works, and where you dwell..." **REVELATION 2:13** "But I have a few things against you, because you have there those who hold the doctrine of (BALAAM, EGYPT), who taught Balak to put a stumbling block before the children of Israel..." **REVELATION 2:14**
4. "To the angel of the church in Thyatira write..." "I know your works, love, service, faith, and your patience; and as for your works, the last are more than the first." **REVELATION 2:19** "Nevertheless I have a few things against you, because you allow that woman (JEZEBEL, JONABEL), who calls herself a prophetess, to teach and beguile My servants..." **REVELATION 2:20**

FILL IN THE BLANK:

5. "To the angel of the church in Sardis write..." "...I know your works, that you have a name that you are alive, but you are dead." **REVELATION 3:1** "Remember therefore how you have received and heard; hold fast and _____." **REVELATION 3:3**

CIRCLE THE CORRECT WORDS:

6. "To the angel of the church in Philadelphia write..." "I know your works. See, I have set before you an open door, and no one can shut it; for you have a little strength, have kept My word, and have not denied My name." **REVELATION 3:8** "Behold, I come quickly! Hold fast what you have, that no one may take your (CROWN, CLOWN)." **REVELATION 3:11**
7. "To the angel of the church of the Laodiceans write..." "I know your works, that you are neither cold nor hot. I could wish you were cold or hot." **REVELATION 3:15** "As many as I love, I rebuke and chasten. Therefore be (ZEALOUS, JEALOUS) and repent." **REVELATION 3:19**

Jesus says to each church...

TRUE OR FALSE:

8. "He who has an ear, let him hear what the Spirit says to the churches..." **REVELATION 2:7**

TRUE OR FALSE

305. THE SEVEN CHURCHES

(REVELATION 1:20-3:22)

P C B I T I E L S K Y M B B D
 E H F L I J R U W E V F Q W C
 R U A O J B E C T Y V P J D A
 G R Y Z A R W R D F S E C I B
 A C B E I E E K C S D N N A F
 M H C P H P L A V T N I A J L
 O E S H P E A R S A A D A T I
 S S U E L N T I S R T L E L H
 S I S S E T N T A M S G C N V
 M T E U D B O A R D P R I J M
 Y B J S A R N Y D Q M A D O E
 R I M I L N S H I N A F O I Y
 N U U J I Q Z T S N L W A M Y
 A K A Z H K R G U F Y V L U S
 J B K T P L S P I R I T S Z Q

CHURCHES
 EPHESUS
 JESUS
 LAMPSTANDS
 LAODICEA

PERGAMOS
 PHILADELPHIA
 REPENT
 REVELATION
 SARDIS

SEVEN
 SMYRNA
 SPIRIT
 STARS
 THYATIRA

HE WHO HAS AN EAR

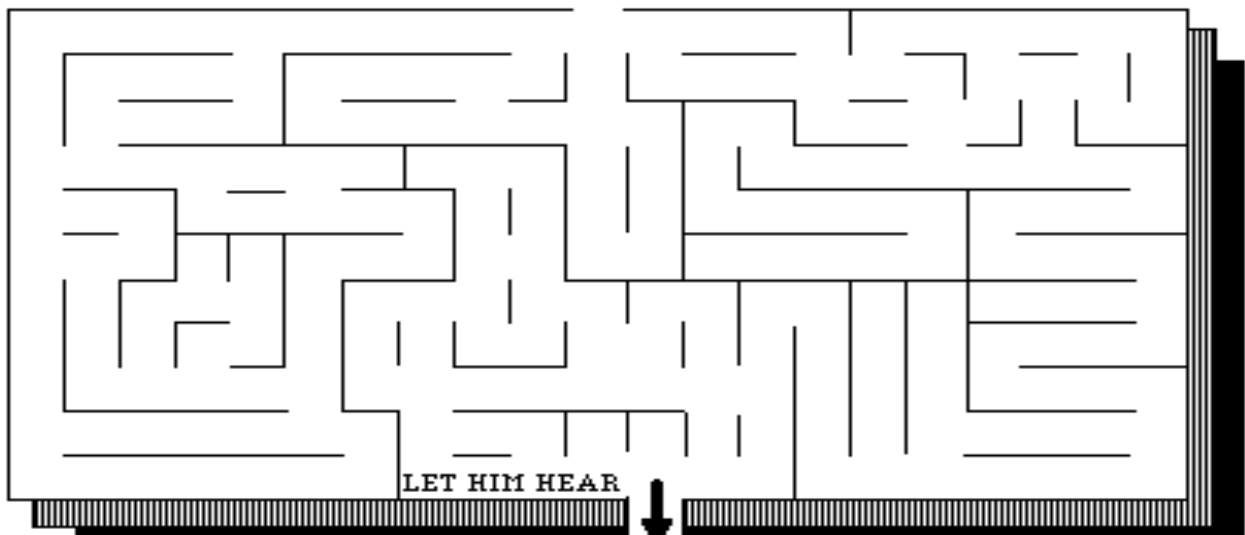

305. THE SEVEN CHURCHES

(REVELATION 1:20-3:22)

MEMORY VERSE:

"Behold, I stand at the door and knock. If anyone hears My voice and opens the door, I will come in to him and dine with him, and he with Me." REVELATION 3:20

Jesus said to John...

TRUE OR FALSE:

1. The seven stars are the angels of the seven churches, and the seven lampstands which you saw are the seven churches." **REVELATION 1:20**

TRUE OR FALSE

2. "To the angel of the church of Ephesus write..." "I know your works, your labor, your patience, and that you cannot bear those who are evil..." **REVELATION 2:2** "Nevertheless I have this against you, that you have left your first love." **REVELATION 2:4**

TRUE OR FALSE

2. "To the angel of the church in Smyrna write..." "I know your works, tribulation, and poverty (but you are rich)..." **REVELATION 2:9** "...Be faithful until death, and I will give you the crown of life." **REVELATION 2:10**

TRUE OR FALSE

FILL IN THE BLANKS:

3. "To the angel of the church in Pergamos write..." "I know your works, and where you dwell..." **REVELATION 2:13** "But I have a few things against you, because you have there those who hold the doctrine of _____, who taught Balak to put a stumbling block before the children of Israel..." **REVELATION 2:14**
4. "To the angel of the church in Thyatira write..." "I know your works, love, service, faith, and your patience; and as for your works, the last are more than the first." **REVELATION 2:19** "Nevertheless I have a few things against you, because you allow that woman _____, who calls herself a prophetess, to teach and beguile My servants..." **REVELATION 2:20**
5. "To the angel of the church in Sardis write..." "...I know your works, that you have a name that you are alive, but you are dead." **REVELATION 3:1** "Remember therefore how you have received and heard; hold fast and _____." **REVELATION 3:3**
6. "To the angel of the church in Philadelphia write..." "I know your works. See, I have set before you an open door, and no one can shut it; for you have a little strength, have kept My word, and have not denied My name." **REVELATION 3:8** "Behold, I come quickly! Hold fast what you have, that no one may take your _____." **REVELATION 3:11**
7. "To the angel of the church of the Laodiceans write..." "I know your works, that you are neither cold nor hot. I could wish you were cold or hot." **REVELATION 3:15** "As many as I love, I rebuke and chasten. Therefore be _____ and repent." **REVELATION 3:19**

Jesus says to each church...

TRUE OR FALSE:

8. "He who has an ear, let him hear what the Spirit says to the churches..." **REVELATION 2:7**

TRUE OR FALSE

305. THE SEVEN CHURCHES

(REVELATION 1:20-3:22)

O D K L O E B C Q S O Y C F L E T G Y N M J T U B I H R E K
 F C E D U B L B D S W H B G J H N L T P H W S A M C J P N L
 G Z Y F P D A P O O J F V I T L B Y T F L S A B G J H G V W
 Q R T A W V E R O E V Q D E B B K T G H A F W G B E M Q A F
 C D E B C N Z E K Z H B I G V R L P F J Z Z I D S H U A O I
 F Y Z R P P C S P P Y H M W Q O D V I K Y Z L U H M N F W W
 C Q Q B R Y A M Z E S E H C R U H C Y Z E E S V P U N W E K
 J Q V E F R L H S U G M O K O W O E M R K S V Z N J R E T O
 K H L W D G W Y T V M J E S U S H N E W G G U Y Z H S J E W
 V F S I M N C Y S F L G O O V H Y V R S Z Y A O P G C N P R
 O O S G E S A M V D U Q F I Y J E J T W S M G R A Q R Q C U
 B I R F T O Z B G I N W U L B L Q A A V B M O C K J G A V A
 Y H S Z L M S P W U V A S D A S R A U H E O J C T W W B T H
 D H B A M A D R D H E L T T C S K H V W W L D H W L K M S O
 G Q B N E G G Y K I E G I S J R G N W S G F Y U O Q Q G M B D
 C U Z S Z R P R A G Z O D S P V O Y A R B A E B Y P Q J Q B
 B N N H I E C E N P N B I U N M J W T V T W Q R K W N L B K
 E U W U I P V A G K U W V J B J A C Z I T U W B Z E G F M S
 K M L S D W U B S R U D E A L D M L R B D U D P U T H Z I L
 Y N Y Y Z Y I N A E I I M I L U N A V K P R I G H T H A N D
 S P I R I T E V U N T C N H D V R N K G T Y U I M F W A T Z
 B V L J P V P T K A Q P B P N C M R B P C O A Y P O Z P N I
 Z A N N E Z N O S I B L A L K G I G M E P L B V G R G M B C
 U S N S Z U S J Y P V O S E A O F I S I N P C N K U V B P D
 F L D R V G C Q B A E C I D O A L K H N B Z Q W L A P R Y C
 J B C D Y F N L F Q B P P A U Q J F J A I P K E W M C Z P Q
 U M V Y U M P P L F W D W L W A Q T L V V Z H H T Q U L Z U
 B I O I D Y S V K R Y Q J I K E E S R I G B C Z K P E I I W
 K O S B W I C G I C U J H H Y G P T B W U M H J N B T A C B
 B X K L E F N Y Q G G J N P Y A G O K A K P L Q I T N B B Q

ANGELS
 CHURCHES
 EPHEBUS
 JESUS
 LAMPSTANDS
 LAODICEA

PERGAMOS
 PHILADELPHIA
 REVELATION
 RIGHTHAND
 SARDIS

SEVEN
 SMYRNA
 SPIRIT
 STARS
 THYATIRA

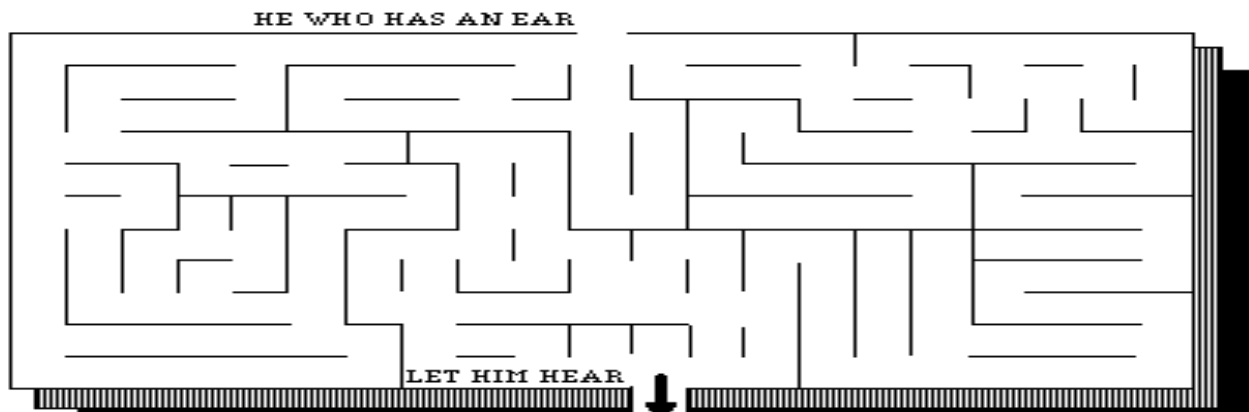

305. THE SEVEN CHURCHES

(REVELATION 1:20-3:22)

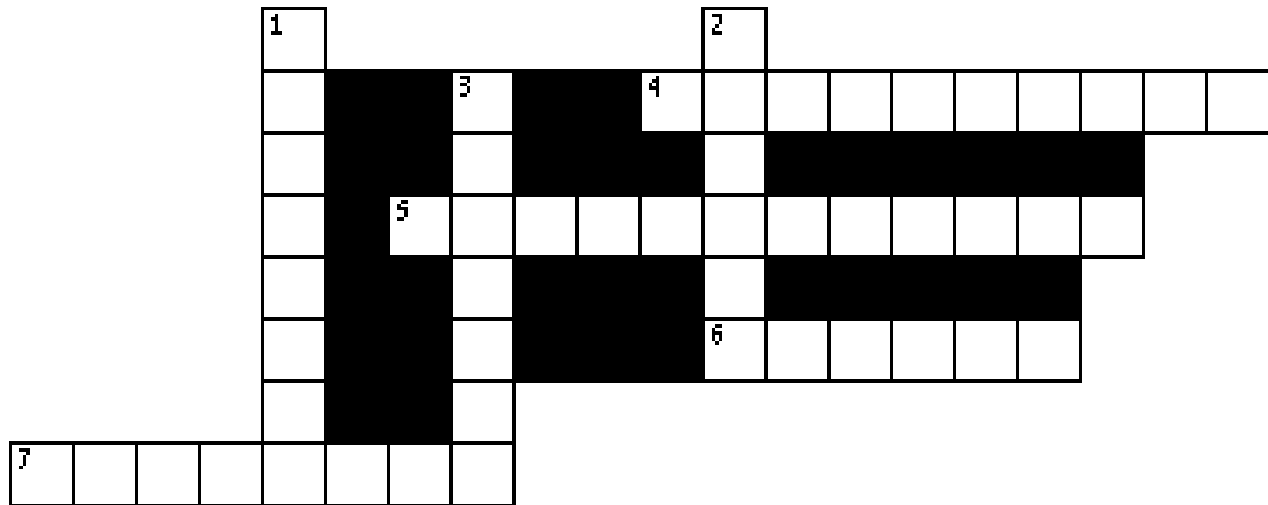

- 3 DOWN "To the angel of the church of _____ write..."
 "I know your works, your labor, your patience, and that you cannot bear those who are evil..."
REVELATION 2:2
 "Nevertheless I have this against you, that you have left your first love." **REVELATION 2:4**
- 6 ACROSS "To the angel of the church in _____ write..."
 "I know your works, tribulation, and poverty (but you are rich)..." **REVELATION 2:9**
 "...Be faithful until death, and I will give you the crown of life." **REVELATION 2:10**
- 7 ACROSS "To the angel of the church in _____ write..."
 "I know your works, and where you dwell..." **REVELATION 2:13**
 "But I have a few things against you, because you have there those who hold the doctrine of Balaam, who taught Balak to put a stumbling block before the children of Israel..." **REVELATION 2:14**
- 1 DOWN "To the angel of the church in _____ write..."
 "I know your works, love, service, faith, and your patience; and as for your works, the last are more than the first." **REVELATION 2:19**
 "Nevertheless I have a few things against you, because you allow that woman Jezebel, who calls herself a prophetess, to teach and beguile My servants..." **REVELATION 2:20**
- 2 DOWN "To the angel of the church in _____ write..."
 "...I know your works, that you have a name that you are alive, but you are dead." **REVELATION 3:1**
 "Remember therefore how you have received and heard; hold fast and _____."
REVELATION 3:3
- 5 ACROSS "To the angel of the church in _____ write..."
 "I know your works. See, I have set before you an open door, and no one can shut it; for you have a little strength, have kept My word, and have not denied My name." **REVELATION 3:8**
 "Behold, I come quickly! Hold fast what you have, that no one may take your crown."
REVELATION 3:11
- 4 ACROSS "To the angel of the church of the Laodiceans write..."
 "I know your works, that you are neither cold nor hot. I could wish you were cold or hot."
REVELATION 3:15
 "As many as I love, I rebuke and chasten. Therefore be zealous and repent." **REVELATION 3:19**

Bible Story 306

**THE
THRONE ROOM
OF HEAVEN**

Revelation 4:1-11

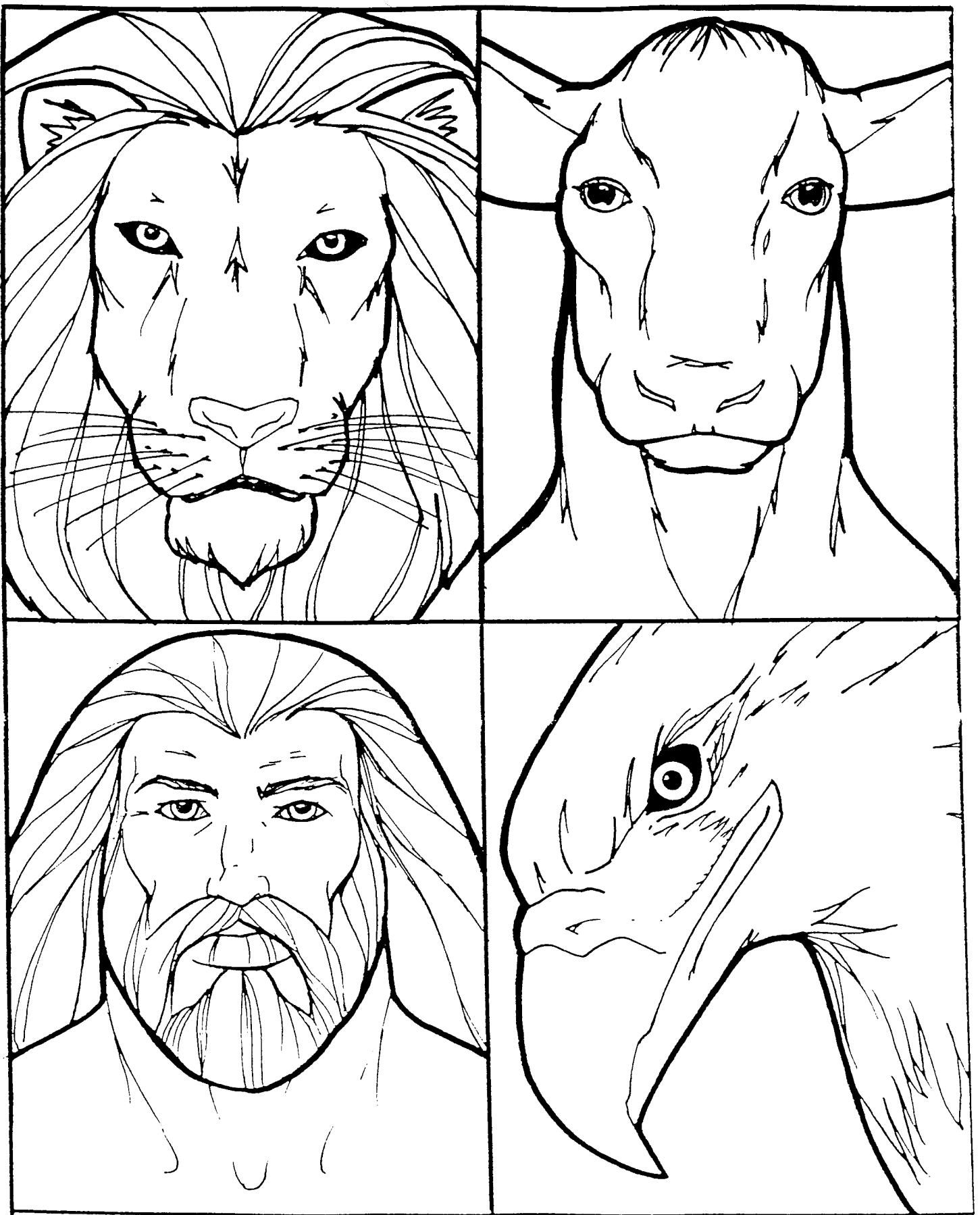

"...the four living living creatures give glory and honor and thanks to Him who sits on the throne, who lives forever and ever."

REVELATION 4:9

306. THE THRONE ROOM OF HEAVEN

(REVELATION 4:1-11)

MEMORY VERSE:

"You are worthy, O Lord, to receive glory and honor and power; for You created all things, and by Your will they exist and were created." REVELATION 4:11

PUT AN X IN FRONT OF THE CORRECT ANSWER:

1. "After these things I looked, and behold, a door standing open in heaven. And the first voice which I heard was like a trumpet speaking with me, saying,..." **REVELATION 4:1**
 "Go away!"
 "Come up here and I will show you things which must take place after this."
2. "And He who sat there was like a jasper and a sardius stone in appearance; and there was _____ around the throne, in an appearance like an emerald." **REVELATION 4:3**
 A rainbow
 A cloud

TRUE OR FALSE:

3. "Around the throne there were twenty-four thrones and on the thrones were sitting twenty-four elders sitting, clothed in white robes; and they had crowns of gold on their heads."
REVELATION 4:4

TRUE OR FALSE

4. "And from the throne proceeded lightnings, thunderings, and voices. And there were seven lamps of fire burning before the throne, which are the seven Spirits of God." **REVELATION 4:5**

TRUE OR FALSE

CIRCLE THE CORRECT WORDS:

5. "Before the throne there was a sea of glass, like (STEEL, CRYSTAL)..." **REVELATION 4:6**
6. "...And in the midst of the throne, and around the throne, were four living (PLANTS, CREATURES) full of eyes in front and in back." **REVELATION 4:6**

TRUE OR FALSE:

7. "Whenever the living creatures give glory and honor and thanks to Him who sits on the throne, who lives forever and ever, the twenty-four elders fall down before Him who sits on the throne and worship Him who lives forever and ever, and cast their crowns before the throne..."
REVELATION 4:9-10

TRUE OR FALSE

306. THE THRONE ROOM OF HEAVEN

(REVELATION 4:1-11)

R E F O W K C S R E D L E K C
A N T Y A R W O R S H I P G P
I J S T O B L E N O R H T Z N
N A T W T S G N I N T H G I L
B H N T S S A R D I U S A S B
O S R G C G L F W S G V J B H
W N U F J R N A W R P I E E E
P Y O I A M E I M V E W S W A
G W F Y S S B A R P I A U G V
G C Y M P G B H T E S M S B E
L N T R E O K J V U D H Z T N
Y R N A R D N K H B R N Y D I
T G E E M E R A L D N E U P V
P I W U Z H T I R I P S S H G
V K T V V J P Z W K A L E T T

CREATURES
CROWNS
ELDERS
EMERALD
GOD
HEAVEN

JASPER
JESUS
LAMPS
LIGHTNINGS
RAINBOW
SARDIUS

SPIRIT
THRONE
THUNDERINGS
TWENTY FOUR
WORSHIP



306. THE THRONE ROOM OF HEAVEN

(REVELATION 4:1-11)

MEMORY VERSE:

"You are worthy, O Lord, to receive glory and honor and power; for You created all things, and by Your will they exist and were created." REVELATION 4:11

FILL IN THE BLANKS:

1. "After these things I looked, and behold, a _____ standing open in heaven. And the first voice which I heard was like a trumpet speaking with me, saying, 'Come up here and I will show you things which must take place after this.' " **REVELATION 4:1**
2. "And He who sat there was like a jasper and a sardius stone in appearance; and there was _____ around the throne, in an appearance like an emerald." **REVELATION 4:3**

TRUE OR FALSE:

3. "Around the throne there were twenty-four thrones and on the thrones were sitting twenty-four elders sitting, clothed in white robes; and they had crowns of gold on their heads."
REVELATION 4:4

TRUE OR FALSE

4. "And from the throne proceeded lightnings, thunderings, and voices. And there were seven lamps of fire burning before the throne, which are the seven Spirits of God."
REVELATION 4:5

TRUE OR FALSE

FILL IN THE BLANKS:

5. "Before the throne there was a sea of glass, like _____..." **REVELATION 4:6**
6. "...And in the midst of the throne, and around the throne, were four living _____ full of eyes in front and in back." **REVELATION 4:6**

TRUE OR FALSE:

7. "Whenever the living creatures give glory and honor and thanks to Him who sits on the throne, who lives forever and ever, the twenty-four elders fall down before Him who sits on the throne and worship Him who lives forever and ever, and cast their crowns before the throne..."
REVELATION 4:9-10

TRUE OR FALSE

306. THE THRONE ROOM OF HEAVEN

(REVELATION 4:1-11)

K M H R L K H I S Y N N A F B C A L T N O Z O U H A Z F C C
 E A E B R R U O F Y T N E W T S S B Q V O E D G F H I H Z P
 K U Q W Z I B E I E I Y P D P W G U T W N V B G I S T E J W
 H L J I P Z P V S Z G Q N M H A K D S O Y L S B R A J Y S B
 Y M B B D A P M B N J Q A Q G V S M R E D G Q E T N B E Z Z
 B I B U H A Y N O P L L E D A W U H I T J N D H K I I D D K
 J F H W M W J I W A D F P I K B T M B U Y L S G C K Y J U I
 V L Z N Y C T I J U K E X D E P L M A R E N F B V R B B M I
 I G Y Y U A V M F Y G Z U B N F M B C K U Y B W B O Q B J U
 E B Q D L H T J K E C C R O W N S O D I O T C N T T S R Y V
 A Y P E K H C C G D B H U V C A O G N W O R S H I P N D U N
 A V V H S O V W A K B F L W B B T R N Z B I L E F E H R R A
 Q E V I S F S H Z J V M I Z C E J H V I Z T J S Z R I K C O
 R Z M I V B E G I Y K C G F C G B P D U R J Y U F E B S E O
 B Y V A Y A H G S Z G G H O T G H O B W S E A B H O P M B Y
 P U O L V B D A N Y V J T J B H G N C A E A D S Z D F M Q D
 F V T E Z Z R V T R E O N L W B Z T V T J A C N P E T G G U
 M M N N N D L B S B A X I N R Y J Y C C M F L M U E N H T Q
 G Y J F I G H I Y I B F N A S B L L A O B K S I P H R A H K
 E A Z S O F Z F T D Y O G Y Q A L C W B T B S D R A T I S N
 W J O R C B E B G A Z B S O U P B O Z U B J C L E F A O Y J
 K R V D R C S L R M R R H P R E Y Y Z M K Y N A M V F Y Z R
 R O L K E B Q Y R D A V Y B G U C Y E P Q Z B W E A W A U B
 G M C S A Z U E K I Q E J E L R Z C T A A I R T R S B E B W
 U Q E F T A Z Q N I V H A A Y B A Y Q J Q V E I A V V H T K
 J D G B U K F B U R E C L Q F M J D H Y T I V R L B N Q O F
 A T V Y R I O T P G Y K C T B K L W D K V J M I D Z F O U N
 H O T D E W N B S B B Z Q S O N T S D Q I S T P U P K V H R
 P U Y C S L M B Q F P M Y C W B A A S K J V Q S K N U C E N
 R C E P W U F B V Q B J V T B H E B F Y I Q S T B S S C D B

CREATURES
 CROWNS
 ELDERS
 EMERALD
 GOD

HEAVEN
 JASPER
 JESUS
 LAMPS
 LIGHTNINGS

RAINBOW
 REVELATION
 SARDIS
 SPIRIT

THRONE
 THUNDERINGS
 TWENTY FOUR
 WORSHIP

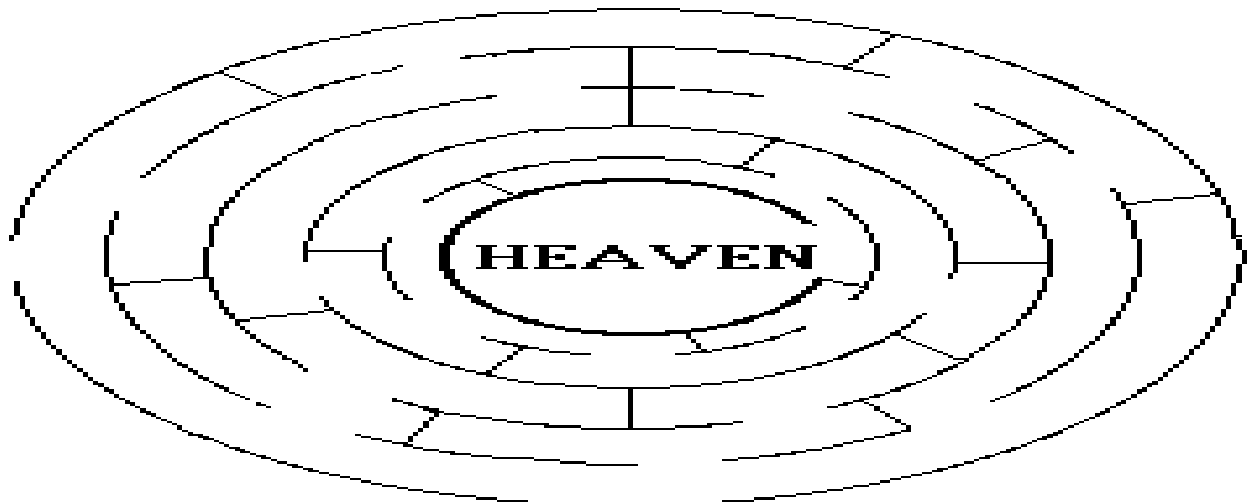

306. THE THRONE ROOM OF HEAVEN

(REVELATION 4:1-11)

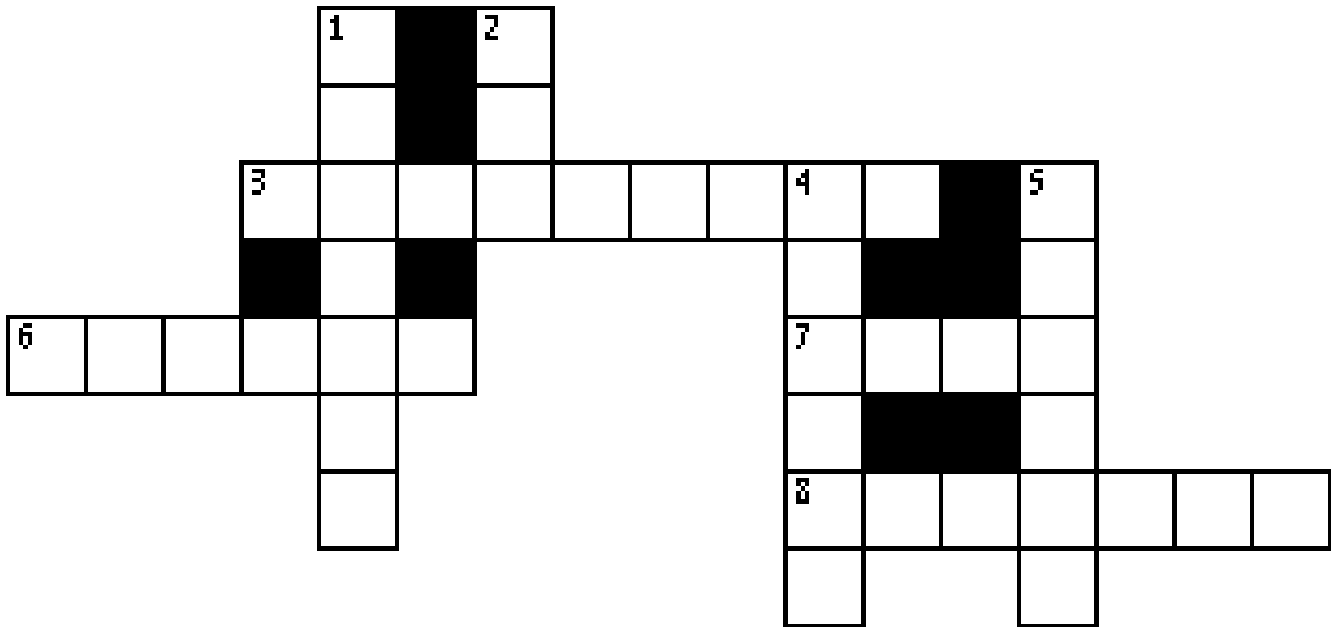

- 7 ACROSS "After these things I looked, and behold, a _____ standing open in heaven. And the first voice which I heard was like a trumpet speaking with me, saying, 'Come up here and I will show you things which must take place after this.'" **REVELATION 4:1**
- 8 ACROSS "And He who sat there was like a jasper and a sardius stone in appearance; and there was a _____ around the throne, in an appearance like an emerald." **REVELATION 4:3**
- 4 DOWN "Around the throne there were twenty-four thrones and on the thrones were sitting twenty-four _____ sitting, clothed in white robes; and they had crowns of gold on their heads." **REVELATION 4:4**
- 5 DOWN "And from the _____ proceeded lightnings, thunderings, and voices. And there were seven lamps of fire burning before the throne, which are the seven Spirits of God." **REVELATION 4:5**
- 2 DOWN "Before the throne there was a _____ of glass, like crystal..." **REV 4:6**
- 3 ACROSS "...And in the midst of the throne, and around the throne, were four living _____ full of eyes in front and in back." **REVELATION 4:6**
- 1 DOWN "Whenever the living creatures give glory and honor and thanks to Him who sits on the throne, who lives forever and ever, the twenty-four elders fall down before Him who sits on the throne and _____ Him who lives forever and ever, and cast their crowns before the throne..." **REVELATION 4:9-10**
- 6 ACROSS "You are _____, O Lord, to receive glory and honor and power; for You created all things, and by Your will they exist and were created." **REVELATION 4:11**

Bible Story 307

**JESUS
TAKES
THE SCROLL**

Revelation 5:1-10

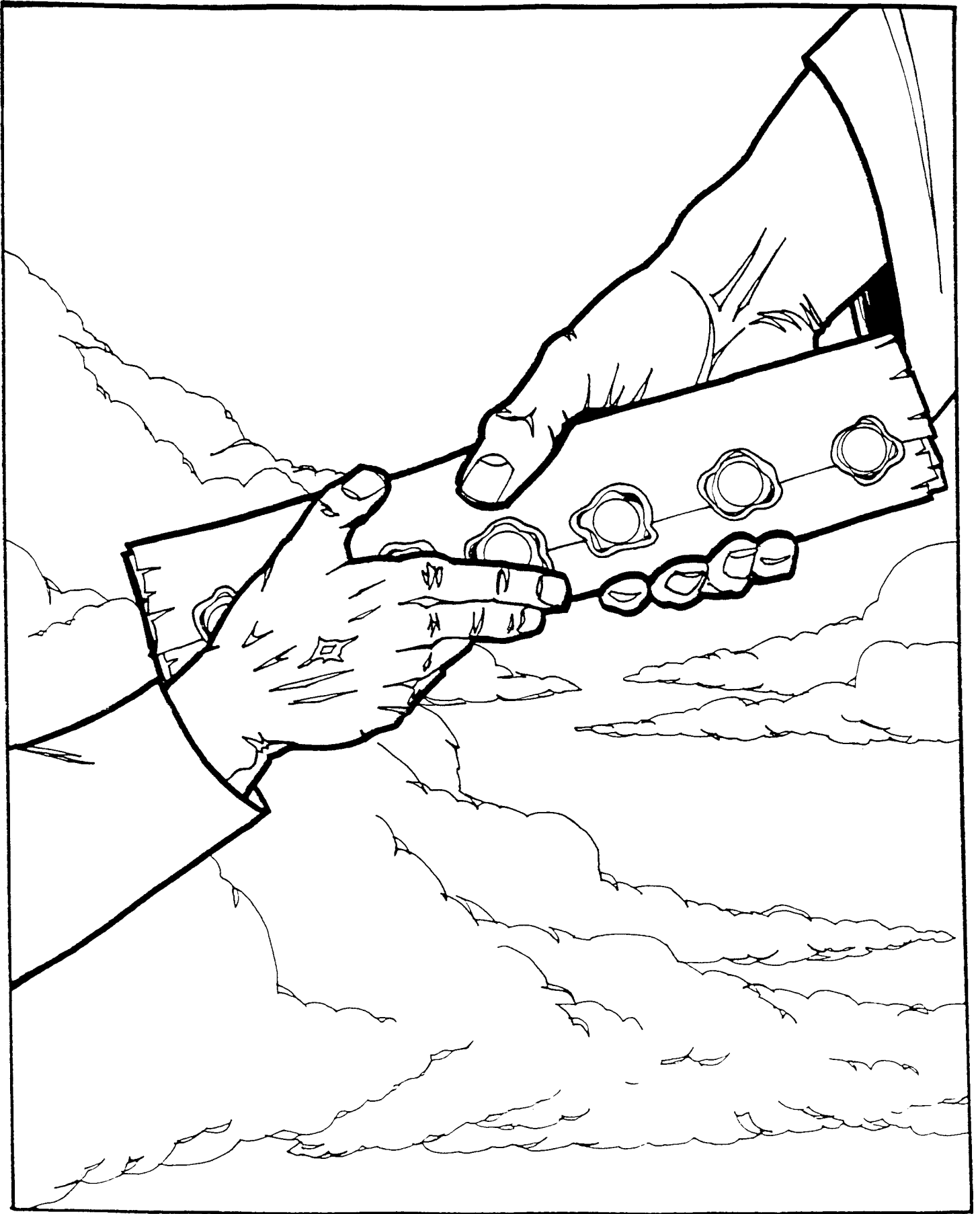

Jesus takes the scroll.
REVELATION 5:1-10

307. JESUS TAKES THE SCROLL

(REVELATION 5:1-10)

MEMORY VERSE:

"You are worthy to take the scroll, and to open its seals; For You were slain, and have redeemed us to God by Your blood" REVELATION 5:9

John writes...

CIRCLE THE CORRECT WORDS:

1. "And I saw in the right hand of Him who sat on the throne a (**STICK, SCROLL**) written inside and on the back, sealed with seven seals." **REVELATION 5:1**
2. "Then I saw a strong angel proclaiming with a loud voice, 'Who is (**WORTHY, READY**) to open the scroll and to loose its seals?' " **REVELATION 5:2**

TRUE OR FALSE:

3. "So I wept much, because no one was found worthy to open and read the scroll, or to look at it." **REVELATION 5:4**

TRUE OR FALSE

CIRCLE THE CORRECT WORD:

4. "But one of the elders said to me, 'Do not weep. Behold, the Lion of the tribe of Judah, the Root of David, has (**PREVAILED, FAILED**) to open the scroll and to loose its seven seals.'" **REVELATION 5:5**

TRUE OR FALSE:

5. "And I looked, and behold, in the midst of the throne and of the four living creatures, and in the midst of the elders stood, a Lamb as though it had been slain..." **REVELATION 5:6**

TRUE OR FALSE

6. "Then He came and took the scroll out of the right hand of Him who sat on the throne." **REVELATION 5:7**

TRUE OR FALSE

CIRCLE THE CORRECT WORD:

7. "Now when He had taken the scroll, the four living creatures and the twenty-four elders fell down before the Lamb, each having a harp, and golden bowls full of incense, which are the (**SONGS, PRAYERS**) of the saints." **REVELATION 5:8**

307. JESUS TAKES THE SCROLL

(REVELATION 5:1-10)

S E S N E C N I C G Y M Z U B
 O P G O E S P F Y W L A M B L
 N T F H A D U J J S E V E N O
 G S C R O L L G U E L P F V O
 A O D E M E E D E R S I T Y D
 U N H A R P J A D C S U O Y U
 W I Y E C N P M Y J E V S N L
 O J Q A N C Q M G N A W I R E
 R S E R U T A E R C L S Z B G
 T J D Y S T N I A S E R T O N
 H Y C U A Z E A T H D E M W A
 Y T M H I B B L I E K Y G L S
 R I G H T H A N D D K A G S S
 E H P A Z R Q O I E J R R T F
 F E N O R H T K P B R P H E J

ANGEL
 BLOOD
 BOWLS
 CREATURES
 ELDER
 HARP

INCENSE
 JESUS
 JUDAH
 LAMB
 LION
 PRAYERS

REDEEMED
 RIGHTHAND
 SAINTS
 SCROLL
 SEALED

SEVEN
 SONG
 THRONE
 WEPT
 WORTHY

START

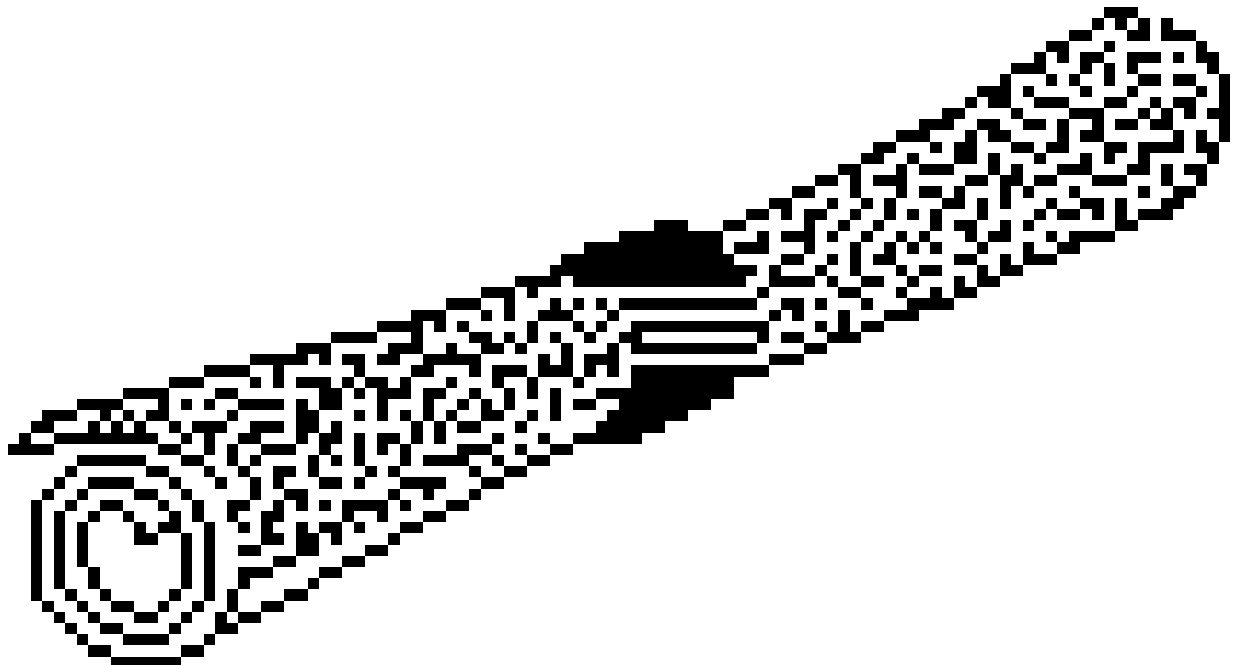

FINISH

307. JESUS TAKES THE SCROLL

(REVELATION 5:1-10)

MEMORY VERSE:

"You are worthy to take the scroll, and to open its seals; For You were slain, and have redeemed us to God by Your blood" REVELATION 5:9

John writes...

FILL IN THE BLANKS:

1. "And I saw in the right hand of Him who sat on the throne a _____ written inside and on the back, sealed with seven seals." **REVELATION 5:1**
2. "Then I saw a strong angel proclaiming with a loud voice, 'Who is _____ to open the scroll and to loose its seals?' " **REVELATION 5:2**

TRUE OR FALSE:

3. "So I wept much, because no one was found worthy to open and read the scroll, or to look at it." **REVELATION 5:4**

TRUE OR FALSE

FILL IN THE BLANK:

4. "But one of the elders said to me, 'Do not weep. Behold, the Lion of the tribe of Judah, the Root of David, has _____ to open the scroll and to loose its seven seals.'" **REVELATION 5:5**

TRUE OR FALSE:

5. "And I looked, and behold, in the midst of the throne and of the four living creatures, and in the midst of the elders stood, a Lamb as though it had been slain..." **REVELATION 5:6**

TRUE OR FALSE

6. "Then He came and took the scroll out of the right hand of Him who sat on the throne." **REVELATION 5:7**

TRUE OR FALSE

FILL IN THE BLANK:

7. "Now when He had taken the scroll, the four living creatures and the twenty-four elders fell down before the Lamb, each having a harp, and golden bowls full of incense, which are the _____ of the saints." **REVELATION 5:8**

307. JESUS TAKES THE SCROLL

(REVELATION 5:1-10)

E Q M F N E J Q D N S W E H C Z T L T O D Y R Q Z H H I E Z
 L V D F Q P K N L I E I P T V B P R T Y K J A U A K M J S C
 V P W T B I G Y U S J H K J U I Z U C E G G P I K H B L B P
 D B Q Q D Y H M F Y J J J P R A Y E R S C A L C R C I J T Y
 D Q B O N B R A L E H D F Y B Z S U M A M K Y C V O V V I E
 Z J O S A B G I S V M T Y R N F C C P E N R M M Z V M R L J
 Z L I H L P D U G U G U R D H Z R Q M Q N I A L S N T R E R
 B I T A Y W S S Y H O O T O B B O N L U Q B T R D I V A D L
 O C A U Q P O V H U T L W C W D L R C T R E S N E C N I I P
 W T L U U Y V B B A V H U G A K L U S V U N F B Y J Q K A P
 H C B T Q F B Y O D S O A S U B W K G S R Y H G E L V J K B
 Q J Z T T O G K I D P U G N V U F E E E E N D S H D U S Q B
 I W L A M B C W R W T I H Q D Y V B P T D M S T Z R G F Y D
 L Y Z D H L O O S E W I B U A E F I Y T E R R S C Z B Q R T
 H J N D T J Z H F T B B V M E E H F U B E Q S E S B D V B P
 T T K Q T W H A Y L H R S J I J N W W D M P M I G Y O B T G
 Y N S C R S K D C A J W U Q S A E L L N E L C R I A N R P B
 O A O E R S K U B R Y G B L G V E E I B D J U P F E Z B K A
 A S B U A I R J D O E T H J J K M J A Y M D R B L M F I Z V
 V L H J W L E L F A K A U T P U J B C Z E D S I B B N U O F
 C P F K P A E W B P P K T S T N I A S E S R J V K Z B Q V R
 A U V S N G N D L A G W Q U Z O Q B L N Z M L S M U A H L F
 L T I M K W C W E I K I T W R Z V K P O P J P M I I D C C Y
 O N O J B A V Z H D O U P K F E E J A R J L B K U J P C Y A
 Z D N T C F C O P Y G N L M B B S K I H H P N I B L U N Y L
 M R H A D U C A T R P M J L B A V U E T D O S R W M K U P Z
 F A I A W T H K L S A T N U K M V M Y A C L L K V P I K D K
 M K I N G S R U U M S H O E M Z L B A B U T P Q K B B S D V
 Q Z U U K O E N W U O F B O P B A Y Q U U P H Y G E R U A M
 S E A E I M M U Q B T O J G R O I R A E S N L C P C Q N W N

BLOOD
 BOWLS
 CREATURES
 DAVID
 ELDERS
 HARP
 INCENSE

JESUS
 JUDAH
 KINGS
 LAMB
 LION
 LOOSE
 OPEN

PRAYERS
 PRIESTS
 REDEEMED
 RIGHTHAND
 ROOT
 SAINTS

SCROLL
 SEALED
 SLAIN
 THRONE
 WEPT
 WORTHY

START

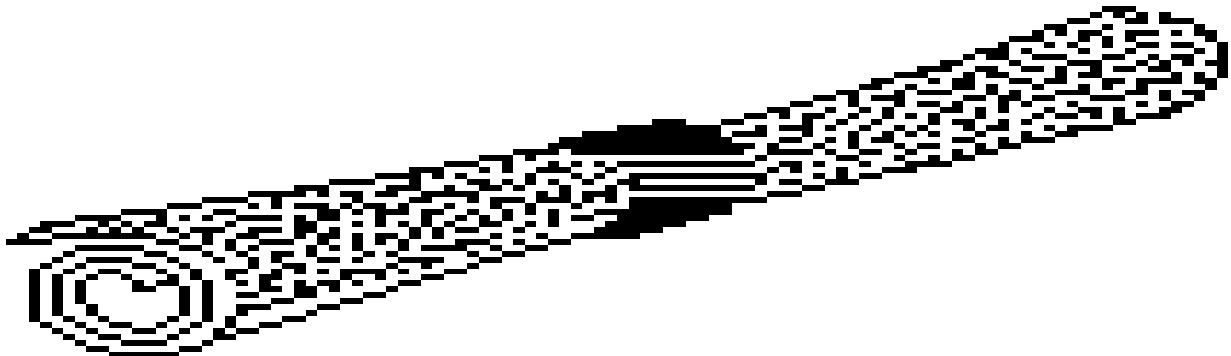

FINISH

307. JESUS TAKES THE SCROLL (REVELATION 5:1-10)

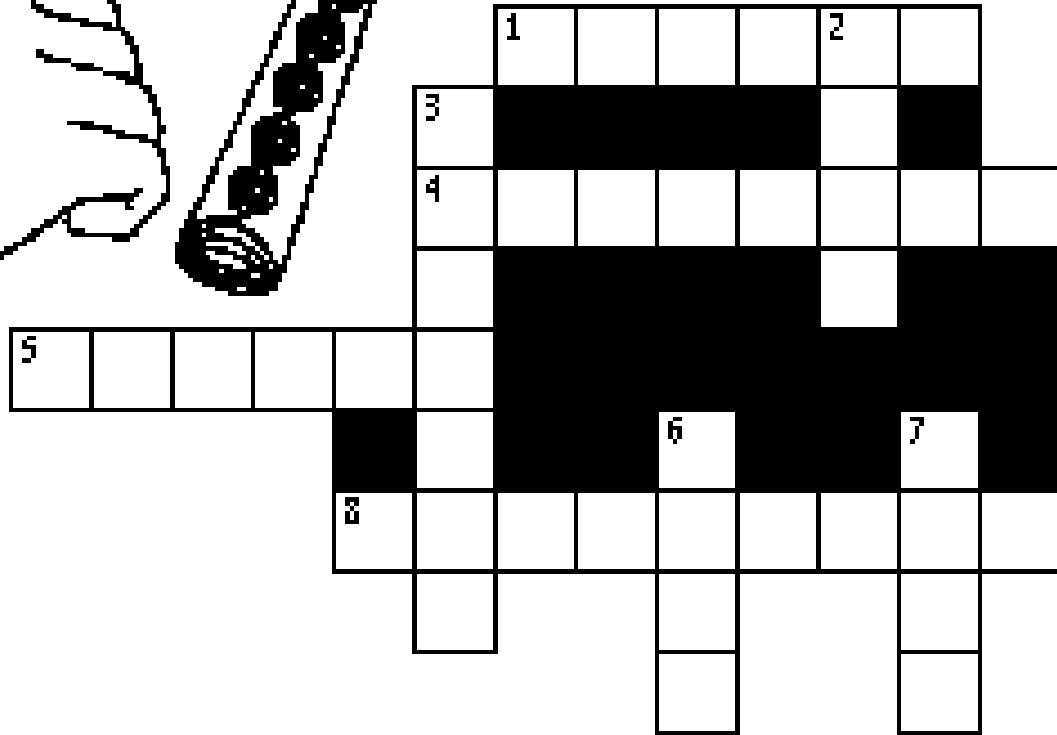
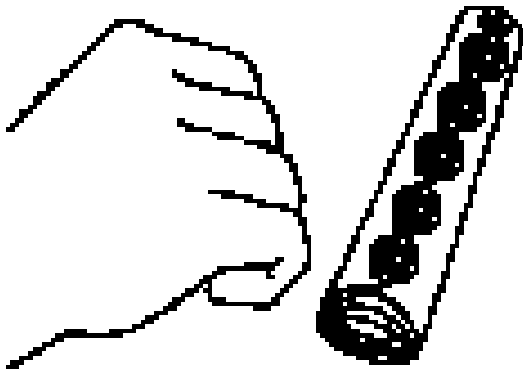

- 1 ACROSS "And I saw in the right hand of Him who sat on the throne a _____ written inside and on the back, sealed with seven seals." **REVELATION 5:1**
- 5 ACROSS "Then I saw a strong angel proclaiming with a loud voice, 'Who is _____ to open the scroll and to loose its seals?' " **REVELATION 5:2**
- 7 DOWN "So I _____ much, because no one was found worthy to open and read the scroll, or to look at it." **REVELATION 5:4**
- 8 ACROSS "But one of the elders said to me, 'Do not weep. Behold, the Lion of the tribe of Judah, the Root of David, has _____ to open the scroll and to loose its seven seals.'" **REVELATION 5:5**
- 2 DOWN "And I looked, and behold, in the midst of the throne and of the four living creatures, and in the midst of the elders stood, a _____ as though it had been slain..." **REVELATION 5:6**
- 6 DOWN "Then He came and took the scroll out of the right _____ of Him who sat on the throne." **REVELATION 5:7**
- 3 DOWN "Now when He had taken the scroll, the four living creatures and the twenty-four elders fell down before the Lamb, each having a harp, and golden bowls full of incense, which are the _____ of the saints." **REVELATION 5:8**
- 4 ACROSS "You are worthy to take the scroll, and to open its seals; For You were slain, and have _____ us to God by Your blood." **REVELATION 5:9**

Bible Story 308

THE SEVEN SEALS

Revelation 6:1-17; 8:1-6

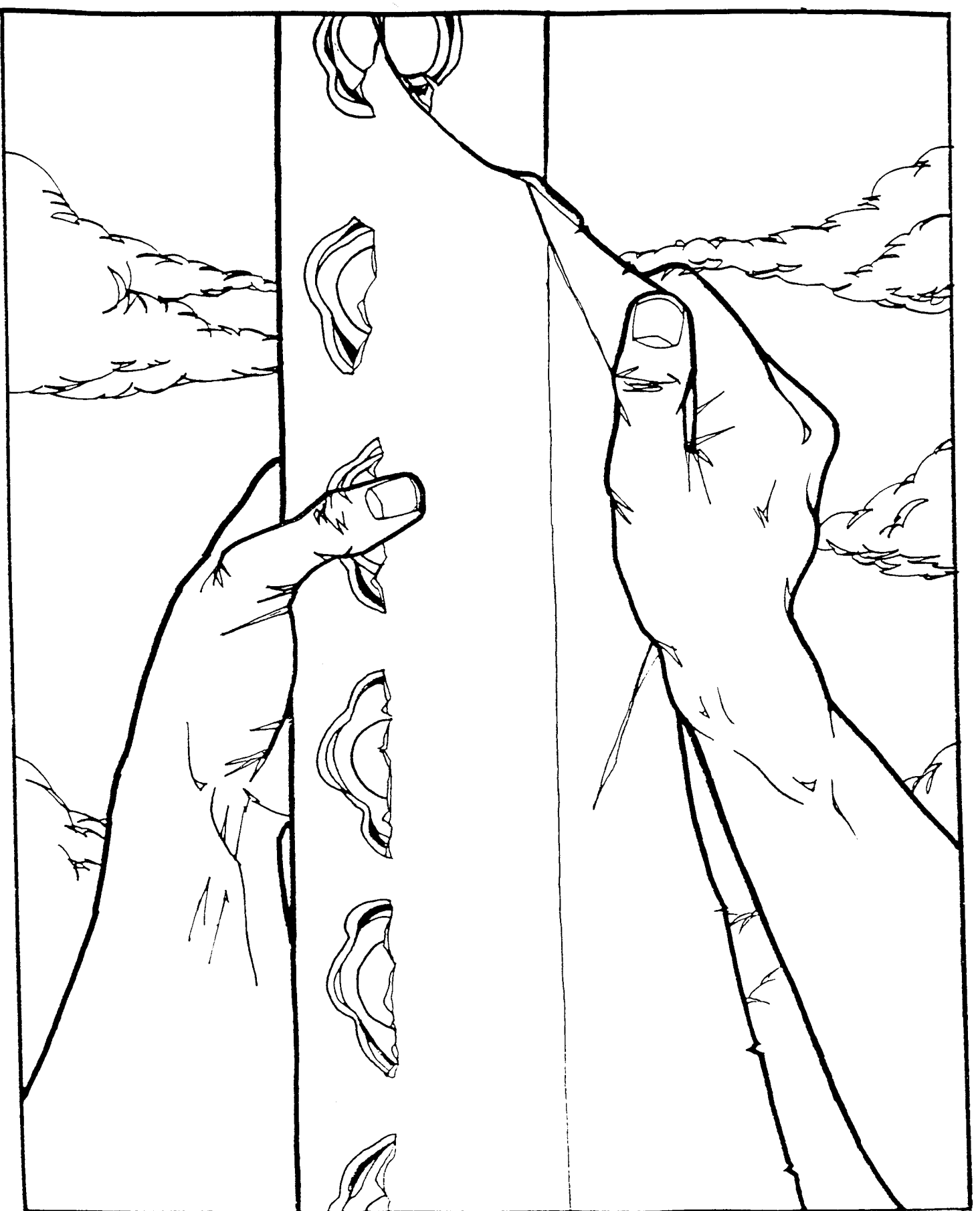

Jesus opens the seven seals.
REVELATION 6:1-17; 8:1-6

308. THE SEVEN SEALS

(REVELATION 6:1-17; 8:1-6)

MEMORY VERSE:

"For the great day of His wrath has come, and who is able to stand?" REVELATION 6:17

"Now I saw when the Lamb opened one of the seals; and I heard one of the four living creatures saying with a voice like thunder, 'Come and see.' "

CIRCLE THE CORRECT WORDS:

1. "And I looked, and behold, a (RED, WHITE) horse. He who sat on it had a (BOW, ARROW); and a (CROWN, SHOE) was given to him, and he went out conquering and to conquer." REVELATION 6:2
"When He opened the second seal, I heard the second living creature saying, 'Come and see.' "

TRUE OR FALSE:

2. "Another horse, fiery red, went out. And it was granted to the one who sat on it to take peace from the earth..." REVELATION 6:4

TRUE OR FALSE

"When He opened the third seal, I heard the third living creature say, 'Come and see.' "

CIRCLE THE CORRECT WORD:

3. "...And I looked, and behold, a black (HORSE, DOG), and he who sat on it had a pair of scales in his hand." REVELATION 6:5
"When He opened the fourth seal, I heard the voice of the fourth living creature saying, 'Come and see.' "

TRUE OR FALSE:

4. "And I looked, and behold, a pale horse. And the name of him who sat on it was Death, and Hades followed with him..." REVELATION 6:8

TRUE OR FALSE

"When He opened the fifth seal, I saw under the altar the souls of those who had been slain for the word of God and for the testimony which they held."

5. Then a white hat was given to each of them... REVELATION 6:11

TRUE OR FALSE

"I looked when He opened the sixth seal, and behold, there was a great earthquake; and the sun became black as sackcloth of hair, and the moon became like blood."

CIRCLE THE CORRECT WORDS:

6. "And the (CLOUDS, STARS) of heaven fell to earth, as a fig tree drops its late figs when it is shaken by a mighty wind." REVELATION 6:13
7. "Then the (SKY, EARTH) receded as a scroll when it is rolled up, and every mountain and island was moved out of its place." REVELATION 6:14
"When He opened the seventh seal, there was silence in heaven for about half an hour."

TRUE OR FALSE:

8. "And I saw the seven angels who stand before God, and to them were given seven trumpets. Then another angel, having a golden censer, came and stood at the altar. He was given much incense, that he should offer it with prayers of all the saints upon the golden altar which was before the throne." REVELATION 8:2-3

TRUE OR FALSE

308. THE SEVEN SEALS

(REVELATION 6:1-17; 8:1-6)

F A S C A L E S U N R B A N A R J H L A
 U O O K U I K T M H B E M E I U B O C I
 A S U P I U J P J B B U G E N W O R C E
 D W V R I M F L Q A K Y Z N L K B S S Y
 A O D G L F Y J L U M E B M U B K E G A
 L R E K T I T B J V Z E T J R H J R E Q
 T D R G H E V J T A B J B U R N E D Y A
 A P S P U K W I W B L A C K U V O I C E
 R A P S N A U H N Y I A P P R A Y E R S
 S D T O D U G T K G N V Z Q H T A R W O
 R Y W T E Q H J M E C O D I H I B T U Y
 A S B W R H B Y L I Z R M V U F U T W E
 T M H I B T V I U S F B E I E E T I H W
 S U H H R R S R N G Z U F A T C M C I A
 D B T J W A U D G C B O V E T S A M A E
 W S A D G E B B Y J E Z F V C U E E C Q
 T E E U T O M C C K D N H V W W R T P U
 L J D O K A H G V P S B S L Q O B E L T
 A M J L L E U S U Z P A L E N L B P S V
 O G Y O W P Q Q B F K S E A L S Y M P S

ALTAR
 BLACK
 BOW
 BURNED
 CROWN
 DEATH
 EARTHQUAKE

FOUR LIVING CREATURES
 HID
 HORSE
 HUNGER
 INCENSE
 LAMB
 PALE

PEACE
 PRAYERS
 RED
 SCALES
 SEALS
 SKY
 STARS

SWORD
 TESTIMONY
 THUNDER
 VOICE
 WHITE
 WRATH

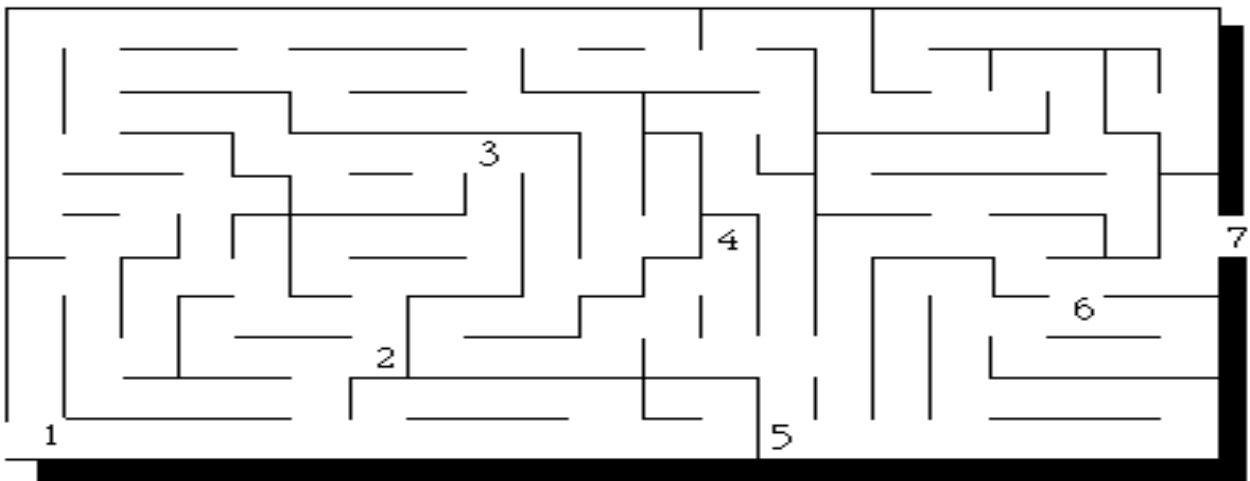

308. THE SEVEN SEALS

(REVELATION 6:1-17; 8:1-6)

MEMORY VERSE:

"For the great day of His wrath has come, and who is able to stand?" REVELATION 6:17
"Now I saw when the Lamb opened one of the seals; and I heard one of the four living creatures saying with a voice like thunder, 'Come and see.' "

FILL IN THE BLANKS:

1. "And I looked, and behold, a _____ horse. He who sat on it had a _____; and a _____ was given to him, and he went out conquering and to conquer." **REVELATION 6:2**
"When He opened the second seal, I heard the second living creature saying, 'Come and see.' "

TRUE OR FALSE:

2. "Another horse, fiery red, went out. And it was granted to the one who sat on it to take peace from the earth..."
REVELATION 6:4

TRUE OR FALSE

"When He opened the third seal, I heard the third living creature say, 'Come and see.' "

FILL IN THE BLANKS:

3. "And I looked, and behold, a _____ horse, and he who sat on it had a pair of _____ in his hand." **REVELATION 6:5**
"When He opened the fourth seal, I heard the voice of the fourth living creature saying, 'Come and see.' "

TRUE OR FALSE:

4. "And I looked, and behold, a pale horse. And the name of him who sat on it was Death, and Hades followed with him..." **REVELATION 6:8**

TRUE OR FALSE

"When He opened the fifth seal, I saw under the altar the souls of those who had been slain for the word of God and for the testimony which they held."

5. Then a white hat was given to each of them... **REVELATION 6:11**
TRUE OR FALSE

"I looked when He opened the sixth seal, and behold, there was a great earthquake; and the sun became black as sackcloth of hair, and the moon became like blood."

FILL IN THE BLANKS:

6. "And the _____ of heaven fell to earth, as a fig tree drops its late figs when it is shaken by a mighty wind." **REVELATION 6:13**
7. "Then the _____ receded as a scroll when it is rolled up, and every mountain and island was moved out of its place." **REVELATION 6:14**
"When He opened the seventh seal, there was silence in heaven for about half an hour."

TRUE OR FALSE:

8. "And I saw the seven angels who stand before God, and to them were given seven trumpets. Then another angel, having a golden censer, came and stood at the altar. He was given much incense, that he should offer it with prayers of all the saints upon the golden altar which was before the throne." **REVELATION 8:2-3**

TRUE OR FALSE

308. THE SEVEN SEALS

(REVELATION 6:1-17; 8:1-6)

E K W R P R E I W Y R Z Q P S B Q K L V B N U D N P B G D Y
 F L P G Z V N U A Y N B Q M F O Q Q B Q J G N Y T V L R L P E
 O Z L G G M T J B F F I H O H N S I B S O S G N G Y A P Q V
 L B P S E S R E Y A R P O Q X I Y C S E L A C S E Y J M H A
 H H B S R E D N U H T P U S M R U R M P A G S M D Q E J B F
 T U C K B C F E B H Q V C B P T V W S Q M L R A O I Z I B B
 A A N Q R R U C B K P U L G G U Q E B A A P Z E G K C A L B
 E H B D J O L W E B U H R E J Q R Z F R B T C H C U G I R T
 D Q E N B W M C C A T K I Q G U T Z E J R H V D J I C C C E
 I W W R Y N A K P E M D M A T P B D U B I E P Y C F O U K S
 F Y G R J E B Y I W W A Z A P E G K V F H O F D I R P V U T
 K I V P P K E I U Z Z O E O A H M N C P A L E N R G W K E I
 H U I M D Y N E E L F R A R B H V W K Y C B B D Y B R K A M
 L I J C V C B J W K C Q T S N F O R P L J N N O K K M S G O
 Z B J A E L U C D G M H G J Z F I D S O B A I O S Y O R T N
 W C B N D A M V N L Q G O U W E T S I J C W S Y C S D H M Y
 Y F S K S T H I N U K J H I R Q Q E R I Y Z B A E G D Z V E
 S E G C B M V K A L F Y N Q A P Q A W G C X M Y V N I W Z V
 O T B P W I J K E V U S N B T L K W K D F N I Q J L E Q S K
 H U V R L P E Y T L E T J O H K H N C H I H Q W B B U W A M
 S U S R T L M V D E N R U B R N R C H P Z F Y Y L B O I V V
 D T U H B Z P B W C E C G H B D K F K Z E T I H W R T B G N
 S O A K Z D O M L S L A E S I E B V L A F S M F D A V L D B
 F B S R Y W R F M F L T L Q J D W V C G S P P S L L H C W F
 W T J K S N A J N S H A D W U G E I N C T N S Y S I H M Z W
 P L D J B O T A L Y U U K E M S B V G C G K B B N U S D S M
 N J C H W H L H I A N I Z Y Y M L V S Z F F T F B W A A W B
 B Q E F D L A B Z G G Y Z V Q E P Y O R G O G Y B M Q Q H Y
 O Q B Y W H C G K V E W N L F Y H S H K J N B Q S J Y Z C C
 Z L U L G A A B K U R A Q K H O R S E V Q T I F T D J Y R O

ALTAR
 BLACK
 BOW
 BURNED
 CROWN
 DEATH
 EARTHQUAKE

FOUR LIVING CREATURES
 HID
 HORSE
 HUNGER
 INCENSE
 LAMB
 PALE

PEACE
 PRAYERS
 RED
 SCALES
 SEALS
 SKY
 STARS

SWORD
 TESTIMONY
 THUNDER
 VOICE
 WHITE
 WRATH

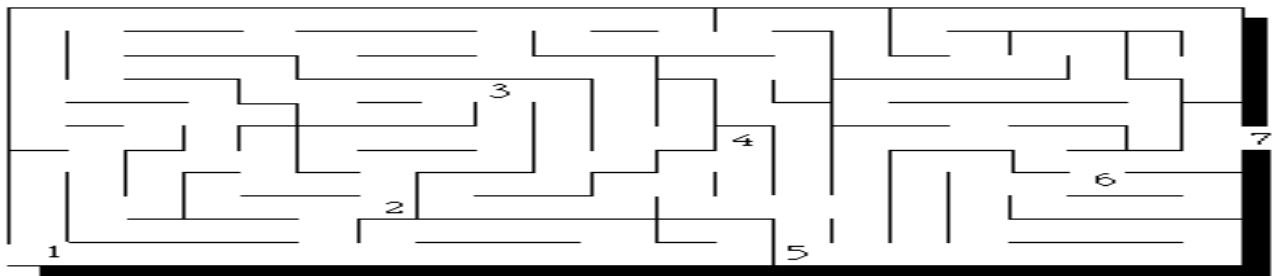

308. THE SEVEN SEALS

(REVELATION 6:1-17; 8:1-6)

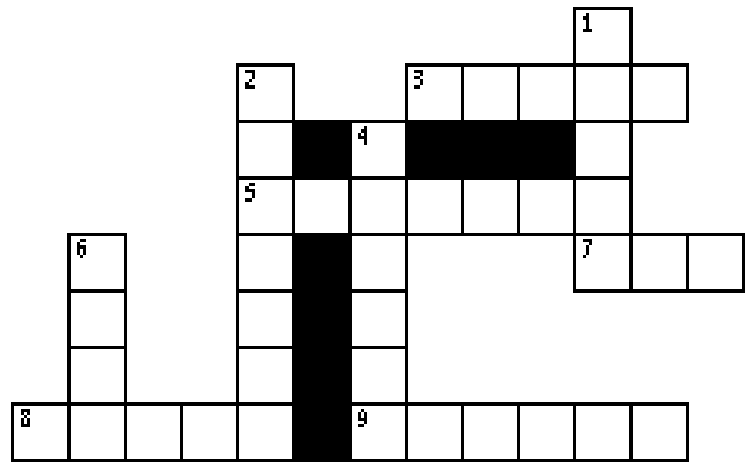
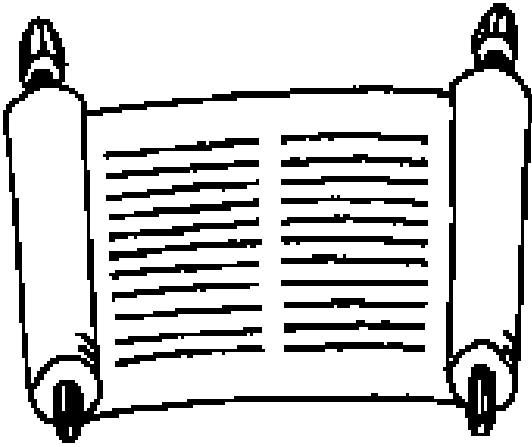

- 5 ACROSS "And I looked, and behold, a white horse. He who sat on it had a bow; and a crown was given to him, and he went out conquering and to ____." **REVELATION 6:2**
- 8 ACROSS "Another horse, fiery red, went out. And it was granted to the one who sat on it to take ____ from the earth..." **REVELATION 6:4**
- 9 ACROSS "...And I looked, and behold, a black horse, and he who sat on it had a pair of ____ in his hand." **REVELATION 6:5**
- 6 DOWN "And I looked, and behold, a ____ horse. And the name of him who sat on it was Death, and Hades followed with him..." **REVELATION 6:8**
- 1 DOWN "And the ____ of heaven fell to earth, as a fig tree drops its late figs when it is shaken by a mighty wind." **REVELATION 6:13**
- 7 ACROSS "Then the ____ receded as a scroll when it is rolled up, and every mountain and island was moved out of its place." **REVELATION 6:14**
- 3 ACROSS "For the great day of His ____ has come, and who is able to stand?" **REVELATION 6:17**
- 4 DOWN "And I saw the seven ____ who stand before God, and to them were given seven trumpets." **REVELATION 8:2**
- 2 DOWN "Then another angel, having a golden censer, came and stood at the altar. He was given much ____, that he should offer it with prayers of all the saints upon the golden altar which was before the throne." **REVELATION 8:3**

Bible Story 309

**THE
SEALED
SERVANTS**

Revelation 7:1-8



John "saw four angels standing at the four corners of the earth, holding the four winds of the earth, that the wind should not blow on the earth, on the sea, or on any tree."

REVELATION 7:1

309. THE SEALED SERVANTS

(REVELATION 7:1-8)

MEMORY VERSE:

"And I heard the number of those who were sealed. One hundred and forty-four thousand of all the tribes of the children of Israel were sealed." REVELATION 7:4

CIRCLE THE CORRECT WORD:

1. "After these things, I saw four angels standing at the four corners of the earth, holding the four (**CLOUDS, WINDS**) of the earth, that the wind should not blow on the earth, on the sea, or on any tree." REVELATION 7:1

TRUE OR FALSE:

2. "Then I saw another angel ascending from the east, having the seal of the living God..." REVELATION 7:2

TRUE OR FALSE

CIRCLE THE CORRECT WORD:

3. "...And he cried with a loud voice to the four angels to whom it was granted to (**HELP, HARM**) the earth and the sea." REVELATION 7:2

TRUE OR FALSE:

4. "Saying, 'Do not harm the earth, the sea, or the trees till we have sealed the servants of our God on their foreheads.'" REVELATION 7:3

TRUE OR FALSE

CIRCLE THE CORRECT WORD:

5. "And I heard the (**VOICE, NUMBER**) of those who were sealed..." REVELATION 7:4

TRUE OR FALSE:

6. "...One hundred and forty-four thousand of all the tribes of the children of Israel were sealed." REVELATION 7:4

TRUE OR FALSE

309. THE SEALED SERVANTS

(REVELATION 7:1-8)

F	J	O	S	E	P	H	Z	J	U	D	A	H	D	T
O	S	E	A	L	A	E	G	A	D	H	O	N	R	Y
U	Q	V	G	G	B	M	R	E	O	L	A	E	T	C
R	P	B	E	U	V	S	D	A	E	H	E	R	O	F
W	A	S	L	E	G	N	A	R	U	O	F	V	M	G
I	U	U	A	S	H	E	R	S	D	B	Y	G	I	D
N	N	M	U	E	L	S	I	M	E	O	N	L	B	Q
D	I	N	V	L	L	V	N	I	M	A	J	N	E	B
S	D	N	A	S	U	O	H	T	E	V	L	E	W	T
W	U	W	B	H	R	A	H	C	A	S	S	I	T	E
Z	W	I	L	A	T	H	P	A	N	J	G	H	R	A
L	R	E	U	B	E	N	O	G	S	E	A	O	B	R
F	O	U	R	C	O	R	N	E	R	S	T	S	D	T
R	R	F	B	E	Z	L	E	A	R	S	I	S	H	H
K	V	D	C	H	E	S	S	A	N	A	M	R	G	J

ASHER
BENJAMIN
EARTH
FOREHEADS
FOUR ANGELS
FOUR CORNERS

FOUR WINDS
GAD
GOD
HARM
ISRAEL
ISSACHAR

JOSEPH
JUDAH
LEVI
MANASSEH
NAPHTALI
REUBEN

SEA
SEAL
SIMEON
TREE
TWELVE THOUSAND
ZEBULUN

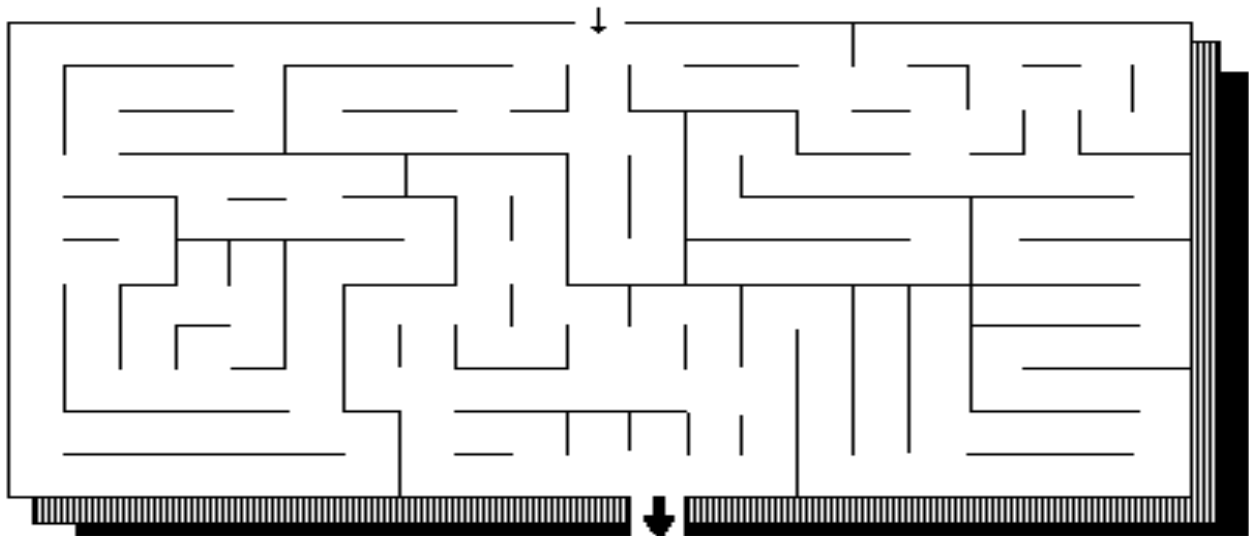

309. THE SEALED SERVANTS

(REVELATION 7:1-8)

MEMORY VERSE:

"And I heard the number of those who were sealed. One hundred and forty-four thousand of all the tribes of the children of Israel were sealed." REVELATION 7:4

FILL IN THE BLANK:

1. "After these things, I saw four angels standing at the four corners of the earth, holding the four _____ of the earth, that the wind should not blow on the earth, on the sea, or on any tree." REVELATION 7:1

TRUE OR FALSE:

2. "Then I saw another angel ascending from the east, having the seal of the living God..." REVELATION 7:2

TRUE OR FALSE

FILL IN THE BLANK:

3. "...And he cried with a loud voice to the four angels to whom it was granted to _____ the earth and the sea." REVELATION 7:2

TRUE OR FALSE:

4. "Saying, 'Do not harm the earth, the sea, or the trees till we have sealed the servants of our God on their foreheads.'" REVELATION 7:3

TRUE OR FALSE

FILL IN THE BLANK:

5. "And I heard the _____ of those who were sealed..." REVELATION 7:4

TRUE OR FALSE:

6. "...One hundred and forty-four thousand of all the tribes of the children of Israel were sealed." REVELATION 7:4

TRUE OR FALSE

309. THE SEALED SERVANTS

(REVELATION 7:1-8)

K N M W P L K T E C S F T Z G F P D V K Q U N P V K A H P R
 Q R H E S S A N A M U K H J I Y Q B Y I T A L T L R F N G T
 J P B B N S P W W S E A M S K Q B Y Y J F U I V E L I B G K
 B I S M U V Z H E C R D O M U D Q N R E V T M J R W M V Z R
 B Q V W O R Y P B M A B E B A C F A T S I E A I R Y I I A B
 R D O U F C Y D A G V K M P V M G P E F D K B P E B O U B W
 B J J U D A H J K H D K B C B P A H U S F A T K V G Q S K U
 K Q J F L M O H S U Q A N D O O M T S A R O E D U P H S O E
 E B J I S R E N R O C R U O F E M A S G N O O H V F U A M E
 F R E B L L J Q U E E T O T U A A L F Q Y A S H E R N L Y O
 J I E N J B F O H C N W B B V Y O I J F M P N A P R H Y S Z
 T L A G J O A A P N R L U B Z U B B S H Z F B Y I Q O J G N
 E S W Y M A S W E Q Y A L G A H C B G R A H C A S S I F U B
 Z T L P S B M E V L Y P P E U A Y J R W U D V S R B P H I B
 E F Z Y Z A H I P K D P M I E E U M A U I H E G F G U W S J
 B A B B F C A V N H J A C K F C D V S I K D F M V B Y Z C H
 U Y D N A S U O H T R U O F Y T R O F D E R D N U H E N O R
 L Y P D P W H M A D I B C B S L E G N A R U O F Q N N A T R
 U O J D O G Z F L A E S V P P N Y W F B N F G B O Q M P E I
 N F H R G J Y S R D P V Z P T A G Z N E M W S E R L H X K S
 J V G C B U N W L O T Q B U O I T F T Y C Y M T B E B I E H
 Z B E G B B J U W K V D F Z N Z I I Q B D I L L I J U C O J
 Z S U R U O T D J Q R V B V I S I Z C T S S C A P V Y B E G
 K V W G B I P S U B F S S F J N P T S D N I W R U O F N E B
 C T W E L V E T H O U S A N D C G M D I N K Y B O U A Z N N
 T M D N C T L J O L E M M R J Z C G Y O Y T D H T R A E S K
 I A W G U E J H E W J C O B Y B J G R W J E T H R B O F M M
 O Z Y Z M J C Q P K O Z A K T R N R Q A D F L P A E M N J I
 T S P L E A R S I I U L T Y H P H H T E V Y T R E E B F D J
 A H Z J D K V O T J G U M R G J E U B P C R V U V S E A H M

ASHER
 BENJAMIN
 EARTH
 FOREHEADS
 FOUR ANGELS
 JOSEPH

GAD
 GOD
 HARM
 ISRAEL
 ISSACHAR
 REUBEN

JUDAH
 LEVI
 MANASSEH
 NAPHTALI
 TWELVE THOUSAND
 ZEBULUN

SEAL
 SEA
 SIMEON
 TREE
 FOUR CORNERS
 FOUR WINDS

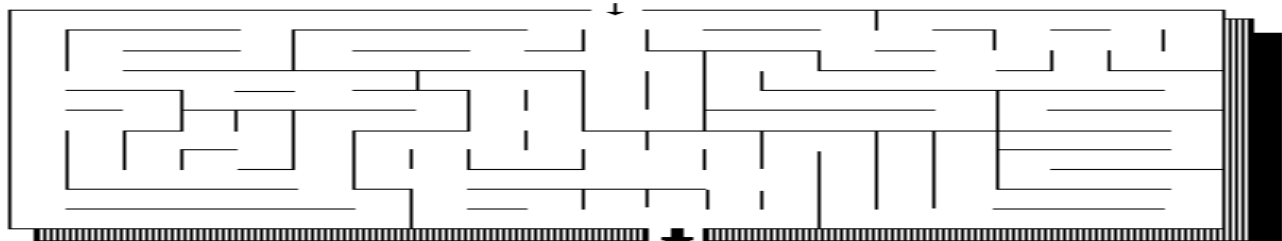

309. THE SEALED SERVANTS

(REVELATION 7:1-8)

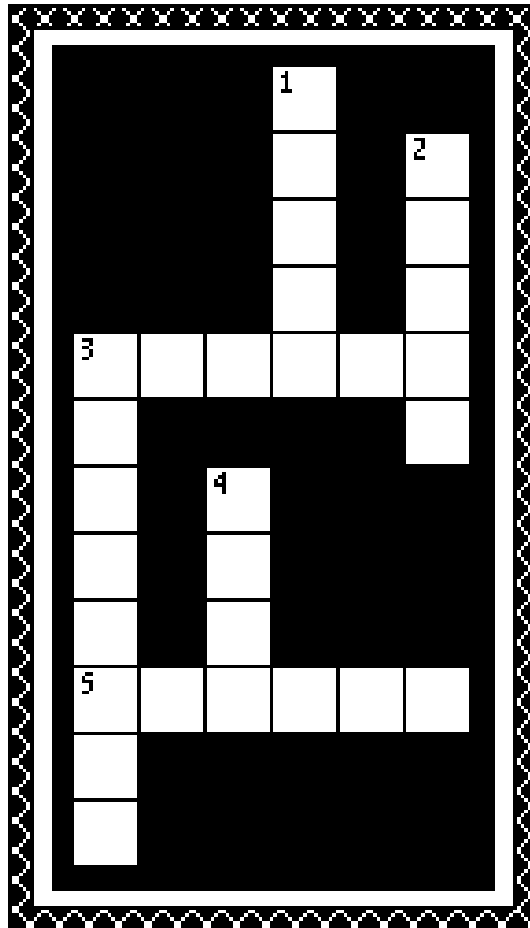

- 2 DOWN "After these things, I saw four angels standing at the four corners of the earth, holding the four _____ of the earth, that the wind should not blow on the earth, on the sea, or on any _____ tree."
REVELATION 7:1
- 1 DOWN "Then I saw another _____ ascending from the east, having the seal of the living God..."
REVELATION 7:2
- 4 DOWN "...And he cried with a loud voice to the four angels to whom it was granted to _____ the earth and the sea." **REVELATION 7:2**
- 3 DOWN "Saying, 'Do not harm the earth, the sea, or the trees till we have sealed the _____ of our God on their foreheads.'" **REVELATION 7:3**
- 5 ACROSS "And I heard the _____ of those who were sealed..." **REVELATION 7:4**
- 3 ACROSS "...One hundred and forty-four thousand of all the tribes of the children of Israel were _____."
REVELATION 7:4

Bible Story 310

**MARTYRS
OF THE GREAT
TRIBULATION**

Revelation 7:9-17



John sees a multitude who are from the Great Tribulation.
REVELATION 7:9-17

310. MARTYRS OF THE GREAT TRIBULATION

(REVELATION 7:9-17)

MEMORY VERSE:

"For the Lamb who is in the midst of the throne will shepherd them and lead them to living fountains of waters. And God will wipe away every tear from their eyes."
REVELATION 7:17

CIRCLE THE CORRECT WORD:

1. "After these things I looked, and behold, a great (**MULTITUDE, OCEAN**) which no one could number, of all nations, tribes, peoples, and tongues, standing before the throne and before the Lamb, clothed with white robes, with palm branches in their hands." **REVELATION 7:9**

TRUE OR FALSE:

2. "...and crying out with a loud voice, saying, 'Salvation belongs to our God who sits on the throne, and to the Lamb!' " **REVELATION 7:10**
TRUE OR FALSE

CIRCLE THE CORRECT WORDS:

3. "And all the angels stood around the throne and the elders and the four living creatures, and fell on their faces before the throne and (**WORRIED, WORSHIPED**) God." **REVELATION 7:11**
4. "Then one of the elders answered and said to me, 'Who are these arrayed in white (**HATS, ROBES**), and where did they come from?' " **REVELATION 7:13**

TRUE OR FALSE:

5. "And I said to him, 'Sir, you know.' So he said to me, 'These are the ones who come out of the great tribulation, and washed their robes and made them white in the blood of the Lamb.' " **REVELATION 7:14**
TRUE OR FALSE

CIRCLE THE CORRECT WORD:

6. "Therefore they are before the throne of God, and (**SEE, SERVE**) Him day and night in His temple. And He who sits on the throne will dwell among them." **REVELATION 7:15**

310. MARTYRS OF THE GREAT TRIBULATION (REVELATION 7:9-17)

T F O U N T A I N S T P M N B
 R B E H O L D W F H Q E I H L
 I D B V V B R Y R Q L O O D O
 B A T L P B M O N K J P Q E O
 U Y S E H C N A R B M L A P D
 L S L R I E T B L G V E H I N
 A G A R R I L W I P E S E H T
 T S B E O I A D T E A R L S R
 I E H N F P V G E B U E P R I
 O B S E U G N O T R B A M O B
 N O N O I T A V L A S F E W E
 I R P V V O K P G O D I T P S
 L I V I N G C R E A T U R E S
 P M U U Q S R Y T R A M U U M
 K W H I T E R A N G E L S Y H

ANGELS
 BEHOLD
 BLOOD
 ELDERS
 FOUNTAINS
 GOD

LAMB
 LIVING CREATURES
 MARTYRS
 NATIONS
 PALM BRANCHES
 PEOPLES

ROBES
 SALVATION
 TEAR
 TEMPLE
 THRONE
 TONGUES

TRIBES
 TRIBULATION
 WHITE
 WIPE
 WORSHIPED

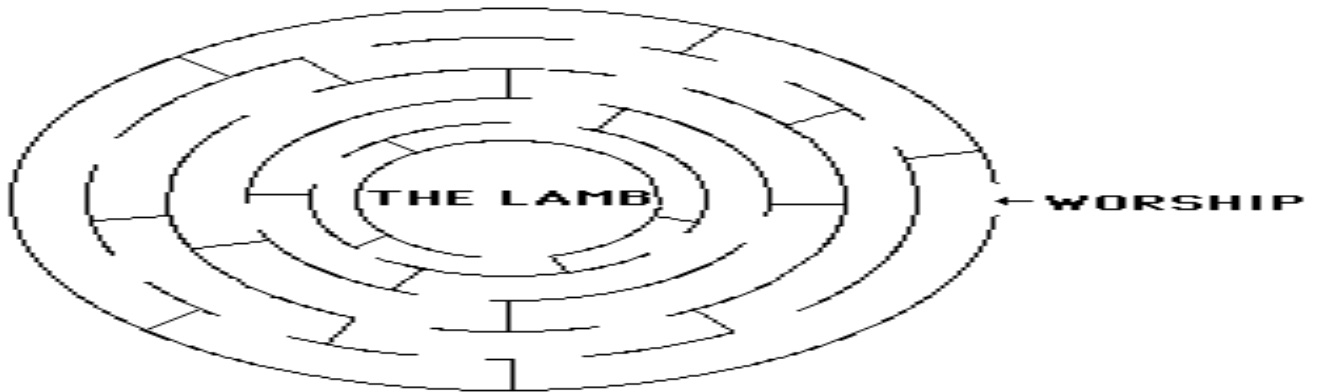

310. MARTYRS OF THE GREAT TRIBULATION

(REVELATION 7:9-17)

MEMORY VERSE:

"For the Lamb who is in the midst of the throne will shepherd them and lead them to living fountains of waters. And God will wipe away every tear from their eyes."
REVELATION 7:17

FILL IN THE BLANK:

1. "After these things I looked, and behold, a great _____ which no one could number, of all nations, tribes, peoples, and tongues, standing before the throne and before the Lamb, clothed with white robes, with palm branches in their hands." **REVELATION 7:9**

TRUE OR FALSE:

2. "...and crying out with a loud voice, saying, 'Salvation belongs to our God who sits on the throne, and to the Lamb!' " **REVELATION 7:10**
TRUE OR FALSE

FILL IN THE BLANKS:

3. "And all the angels stood around the throne and the elders and the four living creatures, and fell on their faces before the throne and _____ God." **REVELATION 7:11**
4. "Then one of the elders answered and said to me, 'Who are these arrayed in white _____, and where did they come from?' " **REVELATION 7:13**

TRUE OR FALSE:

5. "And I said to him, 'Sir, you know.' So he said to me, 'These are the ones who come out of the great tribulation, and washed their robes and made them white in the blood of the Lamb.' " **REVELATION 7:14**
TRUE OR FALSE

FILL IN THE BLANK:

6. "Therefore they are before the throne of God, and _____ Him day and night in His temple. And He who sits on the throne will dwell among them." **REVELATION 7:15**

310. MARTYRS OF THE GREAT TRIBULATION (REVELATION 7:9-17)

E T A G S A H M V D D P P G Z Y M V S G N P F L R A B Z O I
 J T D E P I H S R O W P M E A U A W F Q Y F G A A F H F E S
 Z F E Y Z C Z F A D J A C I U H O Z J F M D E N O R H T N H
 Z A W A F W Y S R O I B C K E A K P S H Z H S B V I N N S J
 K Y L P R J N W L K P V V B F E C E G E U D L H K M B F M G
 C Y Z Y P U J S E B O R Z P P C Y O R W D F C P R I V P J B
 T O B E H O L D W Q T Q K P T N U P A U I U Y U W O I G D K
 I F B B G K T U J K V D F U O A S L S I K W T V Y Q U G H M
 O V P D S E H C N A R B M L A P D E F K N Y D I B H S Z R I
 T B J R K O P D U L R V K Z N I Y S U E M S T L T U S A T J
 A S H C B I D S O W F S S V I Z G F N G C K L R G L A B K M
 N W G G U T L O E K E M M F J S T I T Y N T V R P N U K R S
 R I E R K E J J G I J C O R J N I Z Q B D O P E F H L M B B
 N P U G C J C H P J O Z A K Y C I T C T N E T V Q P Y O W V
 A E W N U K V Q T S U L T K T Z P M D I Y F T U K U J M U M
 T V D G M K T O C U G U M Y H B G G Y O J Y J V G Y H Y E H
 I M S E R U T A E R C G N I V I L R U O F R I P B N W S E Z
 O A W Z D P W E S E F T Z R N O I T A L U B I R T M Z G O I
 N Z Y D O O L B E L P M E T G R C G R W D N P I T H A U Z K
 S S P J L Z H W C A K M J G F P J R Q A V L K R E R P I N Q
 P H Z P S Y P E H V D O S I Y J N H T E C M D F Q L I S K P
 I M W N V Y J B U D B E M K Q P H U B P U A A V L B D B K T
 Q B B U R O H K E Q K M B U D Q E V K Q A B Y Q J Y B E E J
 D S M O C J Q S C E K B P A C B D Y N O I T A V L A S C R S
 J L I V I N G F O U N T A I N S B Y I T U T S B V A I T J S
 Q V W F M F O U N N A N C V M Q Y R J F T O G S L E G N A L
 R O U L L A A H Q R T O D B P F K T E V E N M I U O C E H G
 I J F L B H W P L Y W B T O O G K E F I K K B P B M N K R B
 L J I S R Y T R A M L U B U E A J U S F O V W H I T E E R V
 S E B M B A V E K Y A L B V A M M S A R O E T O E L A M B C

ANGELS
 BEHOLD
 BLOOD
 ELDERS
 FOUR LIVING CREATURES
 GOD

LAMB
 LIVING FOUNTAINS
 MARTYRS
 MULTITUDE
 NATIONS
 PALM BRANCHES

PEOPLES
 ROBES
 SALVATION
 TEAR
 TEMPLE
 THRONE

TONGUES
 TRIBES
 TRIBULATION
 WHITE
 WIPE
 WORSHIPED

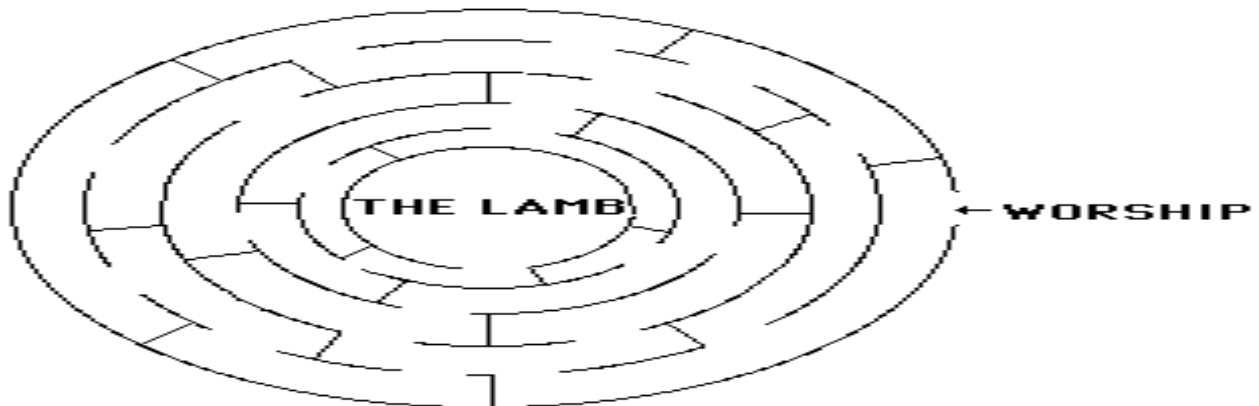

310. MARTYRS OF THE GREAT TRIBULATION

(REVELATION 7:9-17)

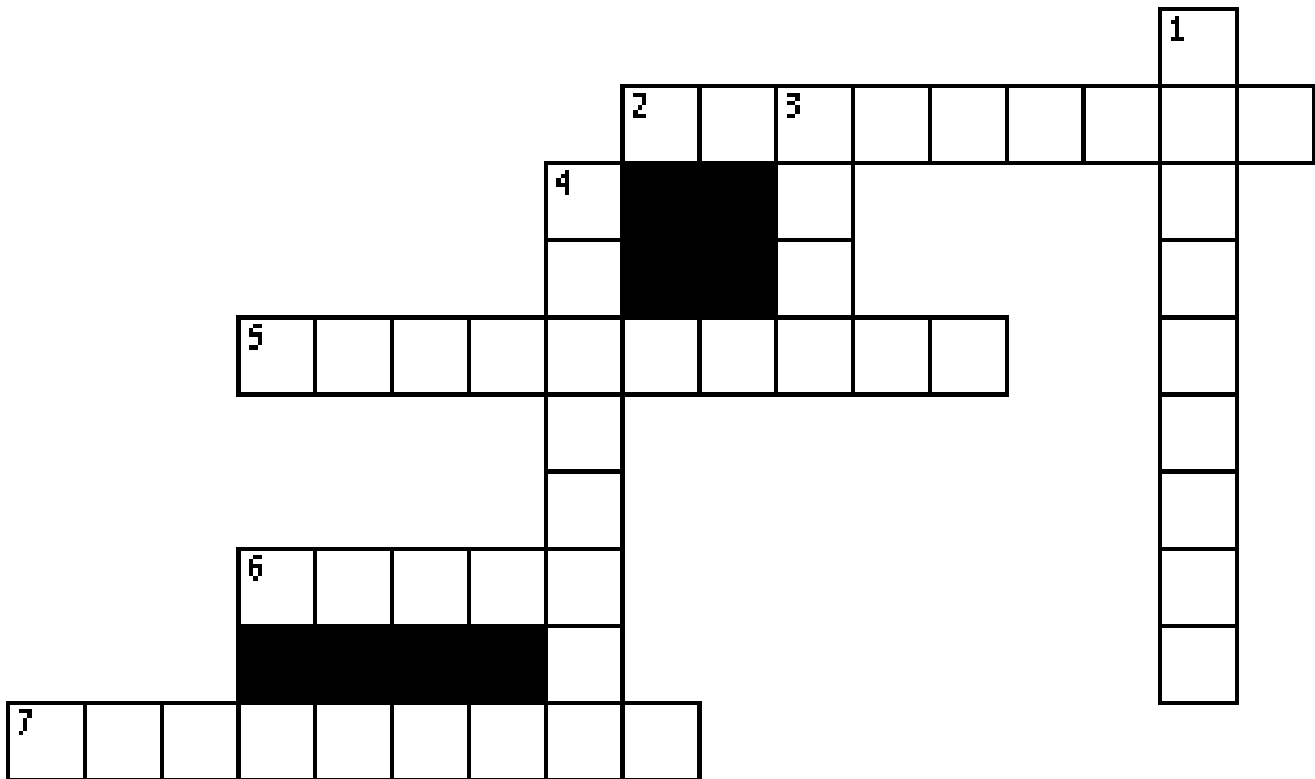

- 7 ACROSS "After these things I looked, and behold, a great _____ which no one could number, of all nations, tribes, peoples, and tongues, standing before the throne and before the Lamb, clothed with white robes, with palm branches in their hands." **REVELATION 7:9**
- 2 ACROSS "...and crying out with a loud voice, saying, ' _____ belongs to our God who sits on the throne, and to the Lamb!' " **REVELATION 7:10**
- 1 DOWN "And all the angels stood around the throne and the elders and the four living creatures, and fell on their faces before the throne and _____ God." **REVELATION 7:11**
- 5 ACROSS "Then one of the elders answered and said to me, 'Who are these arrayed in _____ _____, and where did they come from?' " **REVELATION 7:13**
- 3 DOWN "And I said to him, 'Sir, you know.' So he said to me, 'These are the ones who come out of the great tribulation, and washed their robes and made them white in the blood of the _____.' " **REVELATION 7:14**
- 6 ACROSS "Therefore they are before the throne of God, and _____ Him day and night in His temple. And He who sits on the throne will dwell among them." **REVELATION 7:15**
- 4 DOWN "For the Lamb who is in the midst of the throne will _____ them and lead them to living fountains of waters. And God will wipe away every tear from their eyes." **REVELATION 7:17**

Bible Story 311

**THE
SEVEN
TRUMPETS**

REVELATION 8:7-9:21; 11:15-19



Seven angels sound seven trumpets.
REVELATION 8:7-9:21; 11:15-19

311. THE SEVEN TRUMPETS

(REVELATION 8:6-9:21; 11:15-19)

MEMORY VERSE:

"Then the seventh angel sounded: And there were loud voices in heaven, saying, 'The kingdoms of this world have become the kingdoms of our Lord and of His Christ, and He shall reign forever and ever!' " REVELATION 11:15

So the seven angels who had the seven trumpets prepared themselves to sound...

TRUE OR FALSE:

1. "THE FIRST ANGEL SOUNDED: And hail and fire followed, mingled with blood, and they were thrown to the earth; and a third of the trees were burned up, and all green grass was burned up." REVELATION 8:7
TRUE OR FALSE

CIRCLE THE CORRECT WORD:

2. "THEN THE SECOND ANGEL SOUNDED: And something like a great (MOUNTAIN, BUSH) burning with fire was thrown into the sea..." REVELATION 8:8

UNDERLINE THE CORRECT ANSWER:

3. "THEN THE THIRD ANGEL SOUNDED:..." REVELATION 8:10-11
- a great star fell from heaven
 - the star was burning like a torch
 - the star fell on a third of the rivers and on the springs of water
 - the name of the star is Wormwood
 - all of the above

TRUE OR FALSE:

4. "THEN THE FOURTH ANGEL SOUNDED: And a third of the sun was struck, a third of the moon, and a third of the stars, so that a third of them were darkened." REVELATION 8:12
TRUE OR FALSE

CIRCLE THE CORRECT WORDS:

5. "THEN THE FIFTH ANGEL SOUNDED: And I saw a star fallen from heaven to the earth. And to him was given the (KEY, CHAIN) to the bottomless pit." REVELATION 9:1
6. "THEN THE SIXTH ANGEL SOUNDED: And I heard a voice from the four horns of the golden altar which is before God, saying to the sixth angel who had the trumpet, '(BIND, RELEASE) the four angels who are bound at the great river Euphrates.'" REVELATION 9:13-14

TRUE OR FALSE:

7. "THEN THE SEVENTH ANGEL SOUNDED: And there were loud voices in heaven, saying, 'The kingdoms of this world have become the kingdoms of our Lord and of His Christ, and He shall reign forever and ever!' " REVELATION 11:15
TRUE OR FALSE

311. THE SEVEN TRUMPETS

(REVELATION 8:7-9:21, 11:15-19)

S R I V E R S R A T S M S E E
 C E P Q I V F M B E O O O L
 O C A I U B D U O O M W N S D
 R U R E T T I B N K H M E M E
 P F S T E P M U R T E O V O R
 I I B L O O D A C A A U E D S
 O R Z P W M G V G V V N S G G
 N E L A R N E W E L E T G N L
 W D E P I H S R O W N A O I H
 G V R W A T E R T R V I D K L
 I J S T S U C O L E M N B Y O
 L S L E G N A B L H M W J T R
 H O R S E M E N H L A P O N D
 S W U U V W S P I H S I L O S
 J N K T S I R H C Z R E L E D

ANGELS
 ARK
 BITTER
 BLOOD
 CHRIST
 ELDERS
 FIRE
 HAIL

HEAVEN
 HORSEMEN
 KINGDOMS
 LOCUSTS
 LORD
 MOON
 MOUNTAIN
 PIT

RIVERS
 SCORPION
 SEA
 SEVEN
 SHIPS
 SMOKE
 STAR

SUN
 TEMPLE
 TRUMPETS
 WATER
 WOE
 WORMWOOD
 WORSHIPED

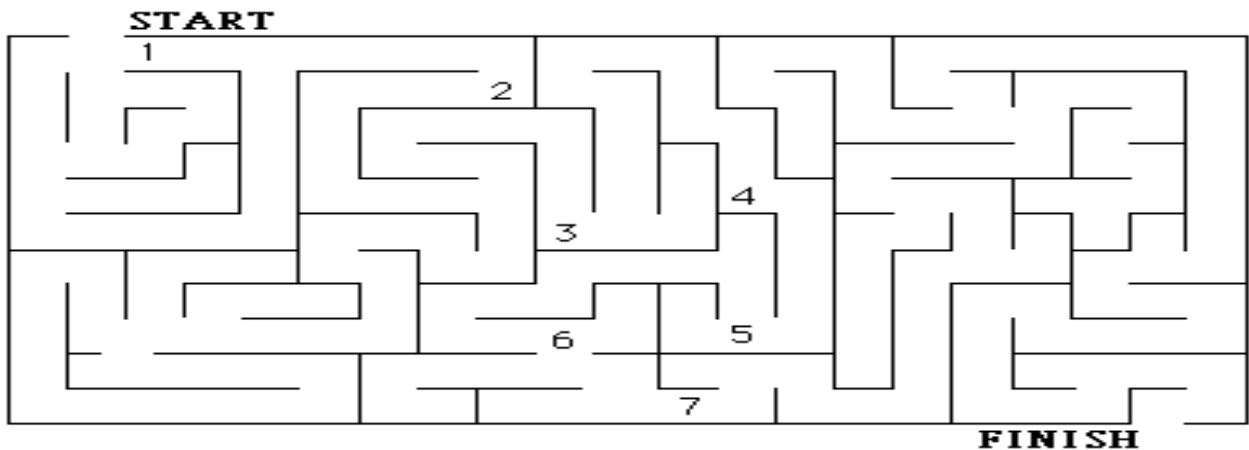

311. THE SEVEN TRUMPETS

(REVELATION 8:6-9:21; 11:15-19)

MEMORY VERSE:

"Then the seventh angel sounded: And there were loud voices in heaven, saying, 'The kingdoms of this world have become the kingdoms of our Lord and of His Christ, and He shall reign forever and ever!'" REVELATION 11:15

So the seven angels who had the seven trumpets prepared themselves to sound...

TRUE OR FALSE:

1. "THE FIRST ANGEL SOUNDED: And hail and fire followed, mingled with blood, and they were thrown to the earth; and a third of the trees were burned up, and all green grass was burned up." REVELATION 8:7
TRUE OR FALSE

FILL IN THE BLANK:

2. "THEN THE SECOND ANGEL SOUNDED: And something like a great _____ burning with fire was thrown into the sea..." REVELATION 8:8

UNDERLINE THE CORRECT ANSWER:

3. "THEN THE THIRD ANGEL SOUNDED:..." REVELATION 8:10-11
- a. a great star fell from heaven
 - b. the star was burning like a torch
 - c. the star fell on a third of the rivers and on the springs of water
 - d. the name of the star is Wormwood
 - e. all of the above

TRUE OR FALSE:

4. "THEN THE FOURTH ANGEL SOUNDED: And a third of the sun was struck, a third of the moon, and a third of the stars, so that a third of them were darkened." REVELATION 8:12
TRUE OR FALSE

FILL IN THE BLANKS:

5. "THEN THE FIFTH ANGEL SOUNDED: And I saw a star fallen from heaven to the earth. And to him was given the _____ to the bottomless pit." REVELATION 9:1
6. "THEN THE SIXTH ANGEL SOUNDED: And I heard a voice from the four horns of the golden altar which is before God, saying to the sixth angel who had the trumpet, '_____ the four angels who are bound at the great river Euphrates.'" REVELATION 9:13-14

TRUE OR FALSE:

7. "THEN THE SEVENTH ANGEL SOUNDED: And there were loud voices in heaven, saying, 'The kingdoms of this world have become the kingdoms of our Lord and of His Christ, and He shall reign forever and ever!'"
REVELATION 11:15
TRUE OR FALSE

311. THE SEVEN TRUMPETS

(REVELATION 8:7-9:21, 11:15-19)

B I B Z Z U E L U L K P A C I E A Y M A I N F C U R I U K E
 K A S G N I R P S W Q T W C K F E U V S K M W Y V W O S O E
 E Q R W J M J J D J K A B V B P C D W F E C D R O L Q S M O
 F D S K P D K C S U T V V Z P T N L Z N Y D Y D L Y H A Y Z
 J J V B N L K S J E L R Q K P O A O F S B N S T R B U L S N
 T Q O M U S P U R O W F D F U N I C I T T Y K L R G N Y G K
 E R S H I P S N H E K E V K Z I Z U Z Q T E T V E P H J U K
 J I J W O V Z V Q P I J S S V J S S T C I J P P V F P H I J
 Z K J U N E M E S R O H M M F J N T M D O D E M U Q U W S H
 Z L I F F R Y T O T J O C O R Y C S G Y W V F T U K Y Z C R
 K S E N A C Y W E C S U Z A K T Z Y G R A S Y J V R N A T R
 C T A I G N O H W S U G L T K H X G R Q E M R I P G T P E I
 T F W B L D G P E B E F U M Y G R T H D O O W M R O W B K S
 C A L G O M O E B C I K T Z R B P I U T P K N P I B M I E H
 H Y Z O L L J M L H A T M J G F O I V B Q E L K R Q H C O J
 R Y L Y M B F J S S V D T S I Y J T Y K T C M D F L B N E G
 I B D E P I H S R O W B O E K Q P P T I F U A A V J Y Z N B
 S O B P M B A H K U D K E M R D Q G Y O V A B Y Q V A F S K
 T F P Y S O H Q R A T S E A U C B C R J M U T S M U O N M M
 F V J B Z A U O S E Q K M B A M Q J T E I L O G H O M F J I
 I B H D F C A N U C E A B P V P F N E F F T E M B E O P D J
 R S G R P W H A T N S T N C B S G H U S R E N S I B A N H M
 E V E C G J Z W H A N R O D E O A E S A S K K B S E B V R S
 I M U G K U Y V P Q I W E V O E M D S R N O V T P P H G E B
 O S C O R P I O N S R N E V U A M B E G Y O E L O A I G T N
 T A W R B K N M E L Y N B T I Y A D F Q M P F A R F N T K V
 A Z D G U O J F V K Y L U B V R L Y J F Z F G B A I B Z R M
 N S W N K I T S A D D A L B Z E O K S H U D S H V M V A B H
 R H Y E L P M E T D J P P G A U K K G W I H H A I L I B W Z
 P M P G C T P W R O I P M E U H C J R U K D L P K W O E U I

- | | | | |
|--|---|--|---|
| <p>ANGELS
ARK
BITTER
BLOOD
BOTTOMLESS PIT
CHRIST
ELDERS
FIRE</p> | <p>HAIL
HEAVEN
HORSEMEN
KINGDOMS
LOCUSTS
LORD
MOON
MOUNTAIN</p> | <p>RIVERS
SCORPIONS
SEA
SEVEN
SHIPS
SMOKE
SPRINGS
STAR</p> | <p>SUN
TEMPLE
TRUMPETS
WATER
WOE
WORMWOOD
WORSHIPED</p> |
|--|---|--|---|

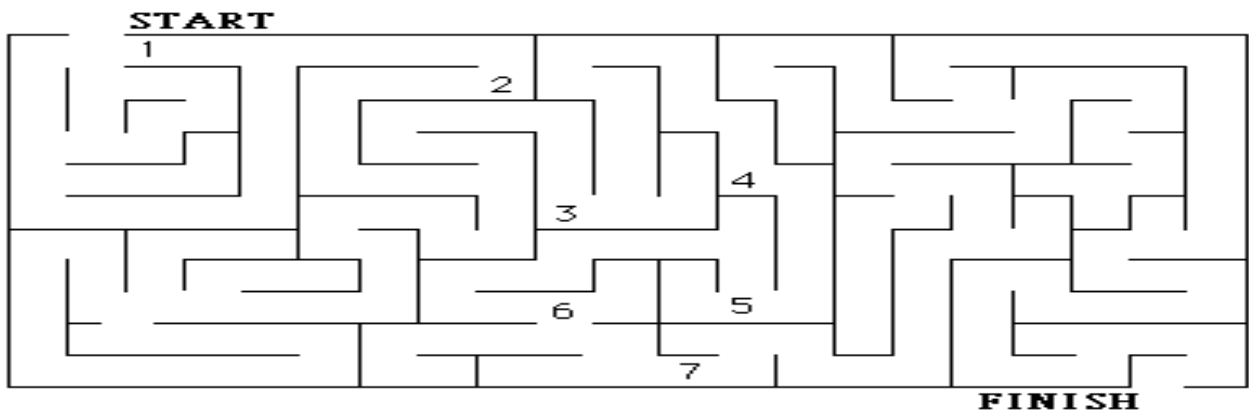

311. THE SEVEN TRUMPETS

(REVELATION 8:6-9:21; 11:15-19)

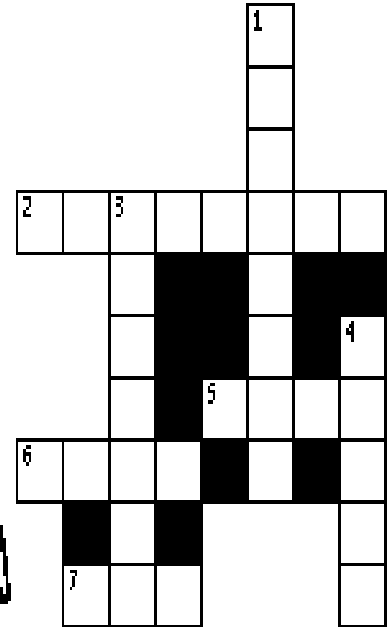
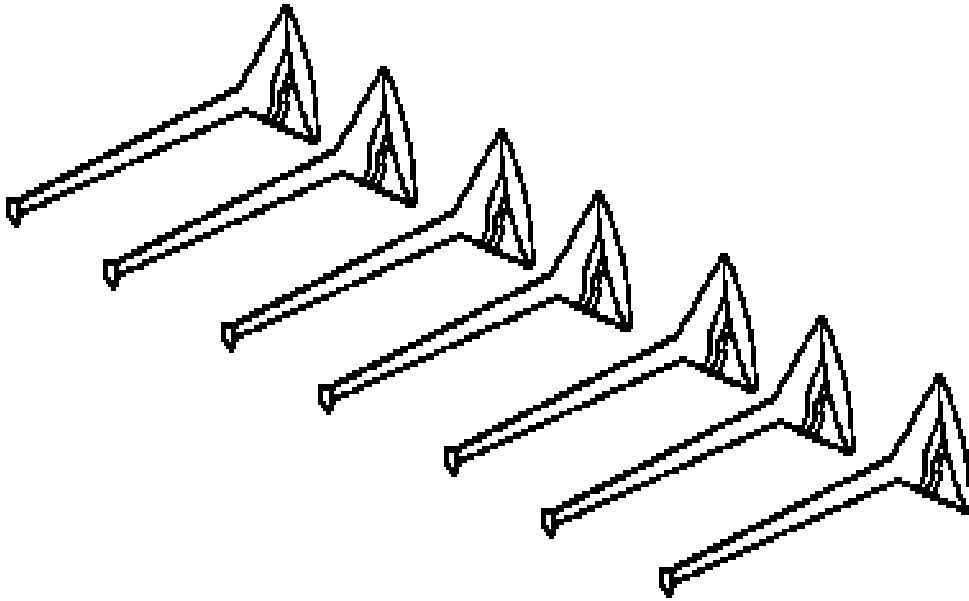

- 5 ACROSS **"THE FIRST ANGEL SOUNDED:** And hail and _____ followed, mingled with blood, and they were thrown to the earth; and a third of the trees were burned up, and all green grass was burned up."
REVELATION 8:7
- 1 DOWN **"THEN THE SECOND ANGEL SOUNDED:** And something like a great _____ burning with fire was thrown into the sea..." **REVELATION 8:8**
- 6 ACROSS **"THEN THE THIRD ANGEL SOUNDED:** And a great _____ fell from heaven, burning like a torch, and it fell on a third of the rivers and on the springs of water; and the name of the star is Wormwood..."
REVELATION 8:10-11
- 2 ACROSS **"THEN THE FOURTH ANGEL SOUNDED:** And a third of the sun was struck, a third of the moon, and a third of the stars, so that a third of them were _____." **REVELATION 8:12**
- 7 ACROSS **"THEN THE FIFTH ANGEL SOUNDED:** And I saw a star fallen from heaven to the earth. And to him was given the _____ to the bottomless pit." **REVELATION 9:1**
- 3 DOWN **"THEN THE SIXTH ANGEL SOUNDED:** And I heard a voice from the four horns of the golden altar which is before God, saying to the sixth angel who had the trumpet, '_____ the four angels who are bound at the great river Euphrates.'" **REVELATION 9:13-14**
- 4 DOWN **"THEN THE SEVENTH ANGEL SOUNDED:** And there were loud voices in heaven, saying, 'The kingdoms of this world have become the kingdoms of our Lord and of His Christ, and He shall _____ forever and ever!' " **REVELATION 11:15**

Bible Story 312

THE TWO WITNESSES

Revelation 11:1-14

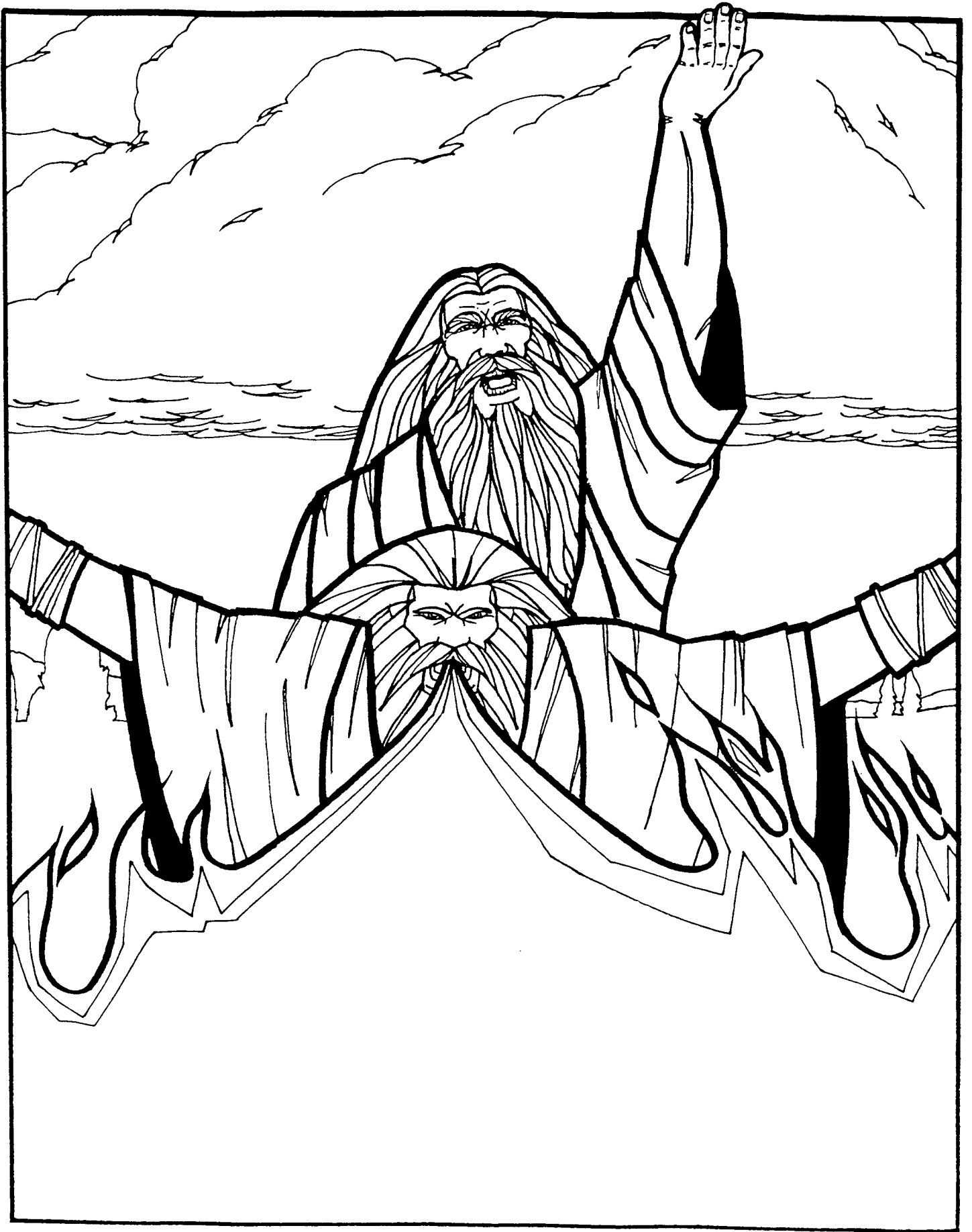

The two witnesses.
REVELATION 11:1-14

312. THE TWO WITNESSES

(REVELATION 11:1-14)

MEMORY VERSE:

"These are the two olive trees and the two lampstands standing before the God of the earth." REVELATION 11:4

CIRCLE THE CORRECT WORD:

1. "Then I was given a reed like a measuring rod. And the angel stood, saying, 'Rise and **(PAINT, MEASURE)** the temple of God, the altar, and those who worship there.' "
REVELATION 11:1

TRUE OR FALSE:

2. "But leave out the court which is outside the temple, and do not measure it, for it has been given to the Gentiles. And they will tread the holy city under foot for forty-two months."
REVELATION 11:2

TRUE OR FALSE

CIRCLE THE CORRECT WORD:

3. "I will give power to my two witnesses, and they will **(CRY, PROPHECY)** one thousand two hundred and sixty days, clothed in sackcloth." REVELATION 11:3

TRUE OR FALSE:

4. "And if anyone wants to harm them, fire proceeds from their mouth and devours their enemies..." REVELATION 11:5

TRUE OR FALSE

5. "Now when they finish their testimony, the beast that ascends out of the bottomless pit will make war against them, overcome them, and kill them." REVELATION 11:7

TRUE OR FALSE

CIRCLE THE CORRECT WORDS:

6. "Now after the three-and-a-half **(DAYS, YEARS)** the breath of life from God entered them, and they stood on their feet, and a great fear fell on those who saw them." REVELATION 11:11
7. "And they heard a loud voice from heaven saying to them, 'Come up here.' And they ascended to heaven in a **(PLANE, CLOUD)**, and their enemies saw them." REVELATION 11:12

312. THE TWO WITNESSES

(REVELATION 11:1-14)

O C V Q K P L Q R A I P Y N S
L O B E R I F I U E W U A B S
I U E B R F G L F O W Y O Y E
V R A B L O O D R E O O M N U
E T S D N A T S P M A L P O G
T V T I W Q H H T U O M B M A
R L P P Y I M E A S U R E I L
E R I O P D E E R F Q A H T P
E S E S S E N T I W O W T S A
S R R R B D E D N E C S A E R
B E Y S E H P O R P H N R T A
H T E M P L E J B I U M A V I
E A R T H Q U A K E N H T I N
P V F A B K B V E M H B L U L
U U V V S E L I T N E G A S Y

ALTAR
ASCENDED
BEAST
BLOOD
COURT
EARTHQUAKE
FIRE
GENTILES

LAMPSTANDS
LIFE
MEASURE
MOUTH
OLIVE TREES
PLAGUES
POWER
PROPHECY

RAIN
REED
TEMPLE
TESTIMONY
TWO WITNESSES
WAR
WORSHIP



312. THE TWO WITNESSES

(REVELATION 11:1-14)

MEMORY VERSE:

"These are the two olive trees and the two lampstands standing before the God of the earth." REVELATION 11:4

FILL IN THE BLANK:

1. "Then I was given a reed like a measuring rod. And the angel stood, saying, 'Rise and _____ the temple of God, the altar, and those who worship there.' "
REVELATION 11:1

TRUE OR FALSE:

2. "But leave out the court which is outside the temple, and do not measure it, for it has been given to the Gentiles. And they will tread the holy city under foot for forty-two months."
REVELATION 11:2

TRUE OR FALSE

FILL IN THE BLANK:

3. "I will give power to my two witnesses, and they will _____ one thousand two hundred and sixty days, clothed in sackcloth." REVELATION 11:3

TRUE OR FALSE:

4. "And if anyone wants to harm them, fire proceeds from their mouth and devours their enemies..." REVELATION 11:5

TRUE OR FALSE

5. "Now when they finish their testimony, the beast that ascends out of the bottomless pit will make war against them, overcome them, and kill them." REVELATION 11:7

TRUE OR FALSE

FILL IN THE BLANKS:

6. "Now after the three-and-a-half _____ the breath of life from God entered them, and they stood on their feet, and a great fear fell on those who saw them." REVELATION 11:11
7. "And they heard a loud voice from heaven saying to them, 'Come up here.' And they ascended to heaven in a _____, and their enemies saw them." REVELATION 11:12

312. THE TWO WITNESSES

(REVELATION 11:1-14)

A Q C F N Y O W D S L O J E H W T P M Z R P A Q C
 Q E R U S A E M R Z L J H B U K V A X J K T Y B J
 F Z C J R O J Y C I B F Q K E G R B N S K O U Q N
 H U Q T P F J P F F B A O S W Y E V O M Y N H F H
 P A I E I V E E G P A H A U O I N N B B R I A G E
 J N F I R E A Z R G C A W H R J F O T P G J E A D
 T A W J Q B W W G K W H V P S S E Q M I I J C M B
 B M S S D N A T S P M A L E H U J D U I L Y N M Y
 I G Z C D S L B N B J Z M V I E O R L C T E A A K
 A F K Z E V Z T G U U Y F A P A U A P D K S S O K
 M H K Z D N R M Z K K N S R C V G I M T U T E K J
 B A Q E J U D W J C O J T L N S F N C B A H I T M
 L W E K O M B E P U I T W W E D K V C B V G Z C V
 O R J C Q A P U D M T P U U O Q D S V G B F S Y W
 O B S E E R T E V I L O G W Q W B M Z E O Y N U Z
 D P B C R Z J F N D E A D J L E I C K I W Q C D F
 B E B T I S H I P L L L S U K N K T F K P A Z Y I
 T S R I L H G R H P J J J O D R K Z N B U O R G Z
 Y G B O S M O W U T K C H E D Y A E K E V D W T T
 R D K T T P E G O S U V Q P O Y L L S P S C B E M
 E A R T H Q U A K E K O O T K P T U M P Z S R I R
 L E T E F B U Y F V P T M C M D W T O U A M E I G
 I P S L A S W P L R Z W E E Q J L M A Z U P P S G
 O Y T S A E B Y L C Y H T S K I A O T V E O J P R
 V Z E A Y V D B M M Y P W C L P P E M F F E P G H

ALTAR
 ASCENDED
 BEAST
 BLOOD
 COURT
 EARTHQUAKE
 FIRE
 GENTILES

LAMPSTANDS
 LIFE
 MEASURE
 MOUTH
 OLIVE TREES
 PLAGUES
 POWER
 PROPHECY

RAIN
 REED
 TEMPLE
 TESTIMONY
 TWO WITNESSES
 WAR
 WORSHIP



312. THE TWO WITNESSES

(REVELATION 11:1-14)

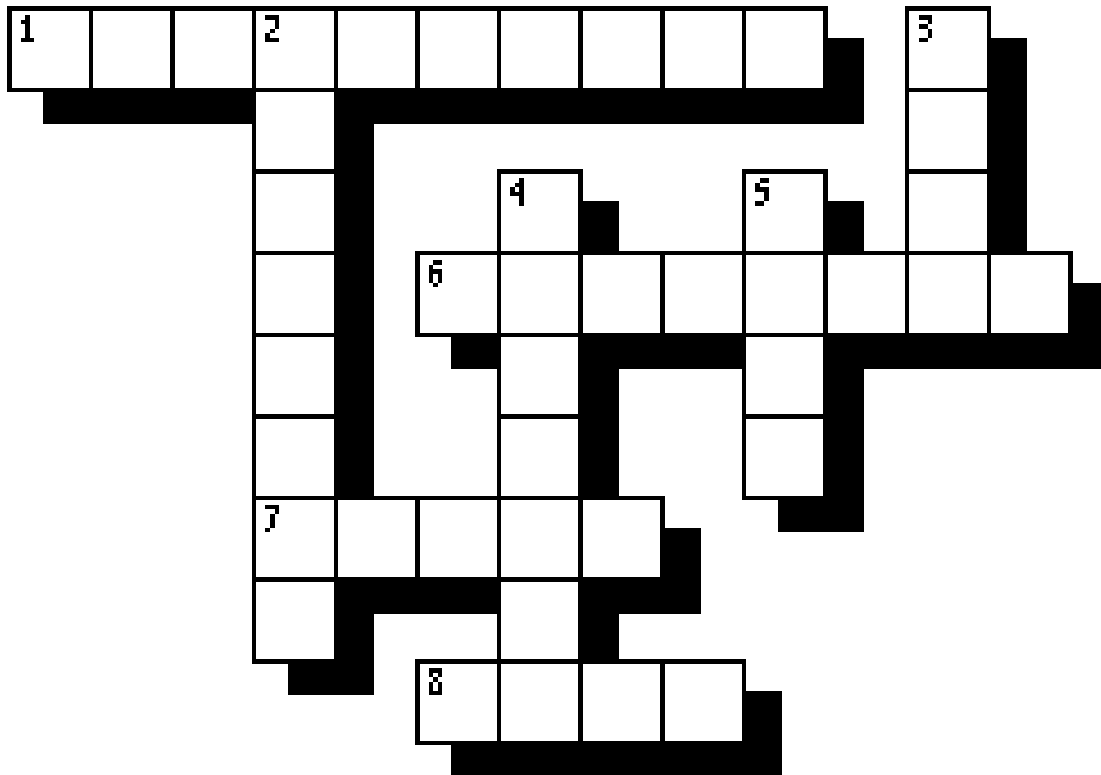

- 4 DOWN "Then I was given a reed like a measuring rod. And the angel stood, saying, 'Rise and _____ the temple of God, the altar, and those who worship there.'" **REVELATION 11:1**
- 6 ACROSS "But leave out the court which is outside the temple, and do not measure it, for it has been given to the _____. And they will tread the holy city under foot for forty-two months." **REVELATION 11:2**
- 2 DOWN "I will give power to my two witnesses, and they will _____ one thousand two hundred and sixty days, clothed in sackcloth." **REVELATION 11:3**
- 1 ACROSS "These are the two olive trees and the two _____ standing before the God of the earth." **REVELATION 11:4**
- 3 DOWN "And if anyone wants to harm them, _____ proceeds from their mouth and devours their enemies..." **REVELATION 11:5**
- 5 DOWN "Now when they finish their testimony, the beast that ascends out of the bottomless pit will make war against them, overcome them, and _____ them." **REVELATION 11:7**
- 8 ACROSS "Now after the three-and-a-half days the breath of life from God entered them, and they stood on their feet, and a great _____ fell on those who saw them." **REVELATION 11:11**
- 7 ACROSS "And they heard a loud voice from heaven saying to them, 'Come up here.' And they ascended to heaven in a _____, and their enemies saw them." **REVELATION 11:12**

Bible Story 313

**THE WOMAN,
THE CHILD
AND THE DRAGON**

Revelation 12:1-17



"Now a great sign appeared in heaven: a woman clothed with the sun, with the moon under her feet, and on her head a garland of twelve stars."

REVELATION 12:1

313. THE WOMAN, THE CHILD AND THE DRAGON (REVELATION 12:1-17)

MEMORY VERSE:

"Then I heard a loud voice saying in heaven, 'Now salvation, and strength, and the kingdom of our God, and the power of His Christ have come.' " REVELATION 12:10

TRUE OR FALSE:

1. "Now a great sign appeared in heaven: a woman clothed with the sun, with the moon under her feet, and on her head a garland of twelve stars." REVELATION 12:1
TRUE OR FALSE

CIRCLE THE CORRECT WORD:

2. "And another sign appeared in heaven: behold, a great, fiery red (FOX, DRAGON) having seven heads and ten horns, and seven diadems on his heads." REV 12:3

TRUE OR FALSE:

3. "And she bore a male Child who was to rule all nations with a rod of iron. And her Child was caught up to God and His throne." REVELATION 12:5
TRUE OR FALSE
4. "Then the woman fled into the wilderness, where she has a place prepared by God, that they should feed her there one thousand two hundred and sixty days." REVELATION 12:6
TRUE OR FALSE

CIRCLE THE CORRECT WORD:

5. "And (WAR, PEACE) broke out in heaven..." REVELATION 12:7

TRUE OR FALSE:

6. "So the great dragon was cast out, that serpent of old, called the Devil and Satan, who deceives the whole world; he was cast to the earth, and his angels were cast out with him." REVELATION 12:9
TRUE OR FALSE

CIRCLE THE CORRECT WORDS:

7. "Now when the dragon saw that he had been cast to the earth, he (PERSECUTED, SAW) the woman who gave birth to the male Child." REV 12:13
8. "But the woman was given two (FEATHERS, WINGS) of a great eagle, that she might fly into the wilderness to her place." REVELATION 12:14

313. THE WOMAN, THE CHILD AND THE DRAGON

(REVELATION 12:1-17)

T H D P Y B V T R C Y E Z Z Q
 E E T P I B Z O T A B M A L N
 S A B R R C A N H M W C S D A
 T D T U G H L E A H C I M N M
 I H N O R I F O D O R N N A O
 M S B Z I L U I G W U A C L W
 O R G V B D E J F P A I T R S
 N A E F U O F J Y O H T E A U
 Y T S I R H C S U S E J E G N
 M S I R A S L E G N A N F R B
 Z B E V L E W T Q E A O L B Q
 J E A G L E P Y D A M G I R F
 W I L D E R N E S S O A V P G
 S P K K V U N G I S O R E J A
 M C B K N E V A E H N D D P M

ANGELS
 BIRTH
 CHILD
 DEVIL
 DRAGON
 EAGLE
 FEET
 GARLAND

HEAD
 HEAVEN
 JESUS CHRIST
 LAMB
 MICHAEL
 MOON
 ROD OF IRON
 SIGN

STARS
 SUN
 TESTIMONY
 TWELVE
 WAR
 WATER
 WILDERNESS
 WOMAN

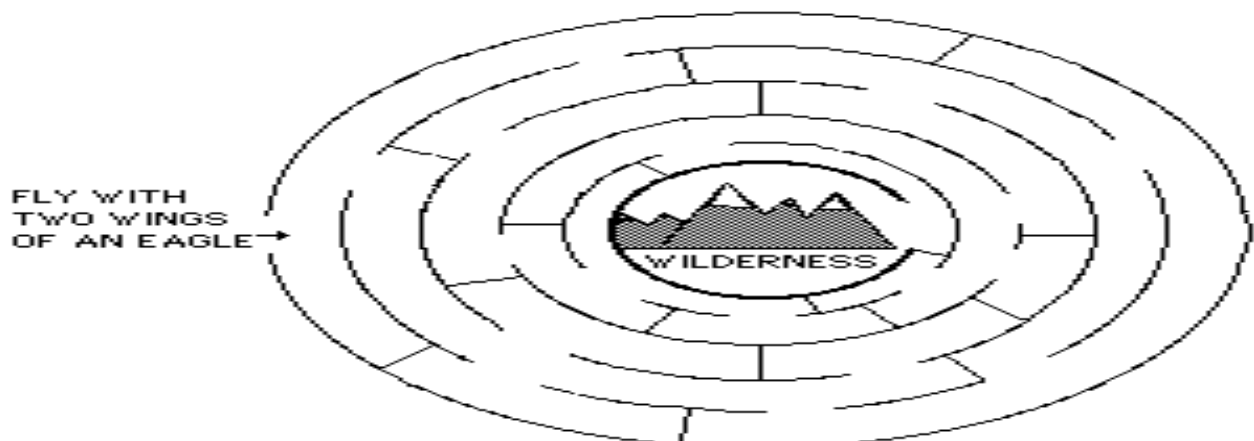

313. THE WOMAN, THE CHILD AND THE DRAGON

(REVELATION 12:1-17)

MEMORY VERSE:

"Then I heard a loud voice saying in heaven, 'Now salvation, and strength, and the kingdom of our God, and the power of His Christ have come.' " REVELATION 12:10

TRUE OR FALSE:

1. "Now a great sign appeared in heaven: a woman clothed with the sun, with the moon under her feet, and on her head a garland of twelve stars." REVELATION 12:1
TRUE OR FALSE

FILL IN THE BLANK:

2. "And another sign appeared in heaven: behold, a great, fiery red _____ having seven heads and ten horns, and seven diadems on his heads." REV 12:3

TRUE OR FALSE:

3. "And she bore a male Child who was to rule all nations with a rod of iron. And her Child was caught up to God and His throne." REVELATION 12:5
TRUE OR FALSE
4. "Then the woman fled into the wilderness, where she has a place prepared by God, that they should feed her there one thousand two hundred and sixty days." REVELATION 12:6
TRUE OR FALSE

FILL IN THE BLANK:

5. "And _____ broke out in heaven..." REVELATION 12:7

TRUE OR FALSE:

6. "So the great dragon was cast out, that serpent of old, called the Devil and Satan, who deceives the whole world; he was cast to the earth, and his angels were cast out with him." REVELATION 12:9
TRUE OR FALSE

FILL IN THE BLANKS:

7. "Now when the dragon saw that he had been cast to the earth, he _____ the woman who gave birth to the male Child." REV 12:13
8. "But the woman was given two _____ of a great eagle, that she might fly into the wilderness to her place." REVELATION 12:14

313. THE WOMAN, THE CHILD AND THE DRAGON (REVELATION 12:1-17)

S M R Q I G K T V Z B L C J Q W C I R B U J U A O
 I D L I H C N A B B G L M F O E S J F V E A G L E
 L H Q B O D E N S P Y M L A A G C S E Q L S Z U E
 S L M F V E V R V J P S B H W L A U J D P M V E A
 J A I H Q P A P M H Y Z B A O B E R O V M B F F Y
 L D P P Z Z E I A G B F A H M K H A L A N G E L S
 F D H J U C H Q Z E D P C Z A S U E H A C P R P U
 F R R N O R I F O D O R W Y N U E A U C N C B T H
 O E Z A A C E D S U R G J N W H C V G S I D B O A
 P U I T G Q F D H W C B U J V P N D F M C M Y N E
 E W V B N O A J M D G B B T M E E V L E W T R I C
 S J V I M E N Q M O R U J P F L Q Q K C V D G J N
 T N B A H I J R B W O K O E I V L E D Z Z T I J A
 A S Q M G W T I S Y G N I V S A K N B L B B K Y I
 R Z S S E N R E D L I W E L S U D R K U F W U T Z
 S K Y B F Z E L V P N D T J W R S Y K T B F A H S
 O B E T H K J S O Z G C E C U L D C A M S G E G N
 O Z L Y A K Z T N W Z U J V D W O Y H O S U V E C
 C F N R W Q Z F J G J M K T S J K H T R M E N F T
 F H V E X J K A J B I D K W J U T D W E I I B Y Z
 T E S T I M O N Y M P S P H R Q J L M O S O Q X
 K N Q A P B C Y E W N L Z P I O K I A B A K T D R
 B G T W E B T Y A U U S Y B Q E L P P N T B U C P
 Y B R A W R I O W F O V Y J O P W T P O M P V M J
 N G A L S B O F L I F R O H E T K V A B Z P Z P P

ANGELS
 BIRTH
 CHILD
 DEVIL
 DRAGON
 EAGLE
 FEET
 GARLAND

HEAD
 HEAVEN
 JESUS CHRIST
 LAMB
 MICHAEL
 MOON
 ROD OF IRON
 SIGN

STARS
 SUN
 TESTIMONY
 TWELVE
 WAR
 WATER
 WILDERNESS
 WOMAN



313. THE WOMAN, THE CHILD AND THE DRAGON (REVELATION 12:1-17)

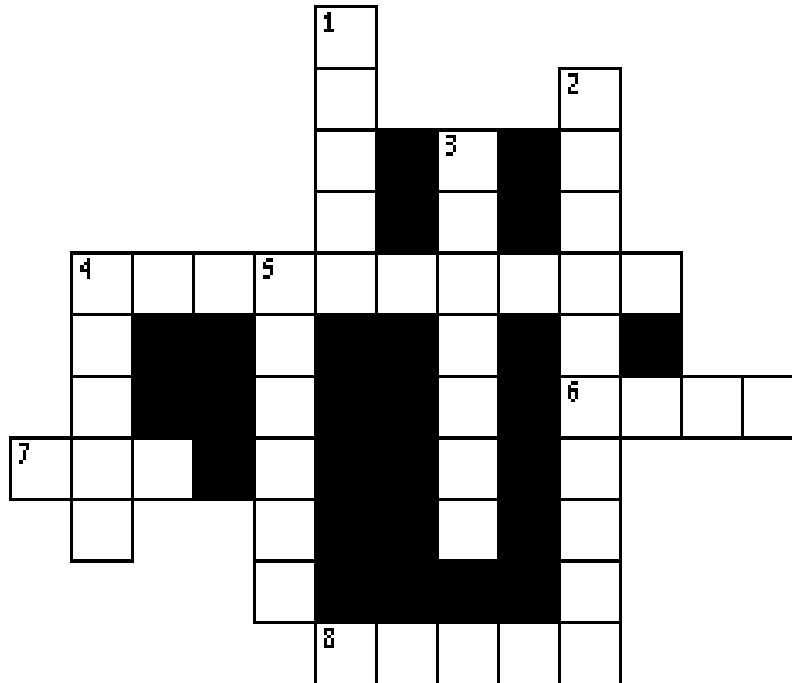

- 4 DOWN "Now a great sign appeared in heaven: a _____ clothed with the sun, with the moon under her feet, and on her head a garland of twelve stars." **REVELATION 12:1**
- 5 DOWN "And another sign appeared in heaven: behold, a great, fiery red _____ having seven heads and ten horns, and seven diadems on his heads." **REVELATION 12:3**
- 8 ACROSS "And she bore a male _____ who was to rule all nations with a rod of iron. And her Child was caught up to God and His throne." **REVELATION 12:5**
- 4 ACROSS "Then the woman fled into the _____, where she has a place prepared by God, that they should feed her there one thousand two hundred and sixty days." **REVELATION 12:6**
- 7 ACROSS "And _____ broke out in heaven..." **REVELATION 12:7**
- 6 ACROSS "So the great dragon was _____ out, that serpent of old, called the Devil and Satan, who deceives the whole world; he was cast to the earth, and his angels were cast out with him." **REVELATION 12:9**
- 3 DOWN "Then I heard a loud voice saying in heaven, 'Now salvation, and strength, and the _____ of our God, and the power of His Christ have come.'" **REVELATION 12:10**
- 2 DOWN "Now when the dragon saw that he had been cast to the earth, he _____ the woman who gave birth to the male Child." **REVELATION 12:13**
- 1 DOWN "But the woman was given two wings of a great _____, that she might fly into the wilderness to her place." **REVELATION 12:14**

Bible Story 314

JESUS AND THE 144,000

Revelation 14:1-5

314. JESUS AND THE 144,000
(REVELATION 14:1-5)

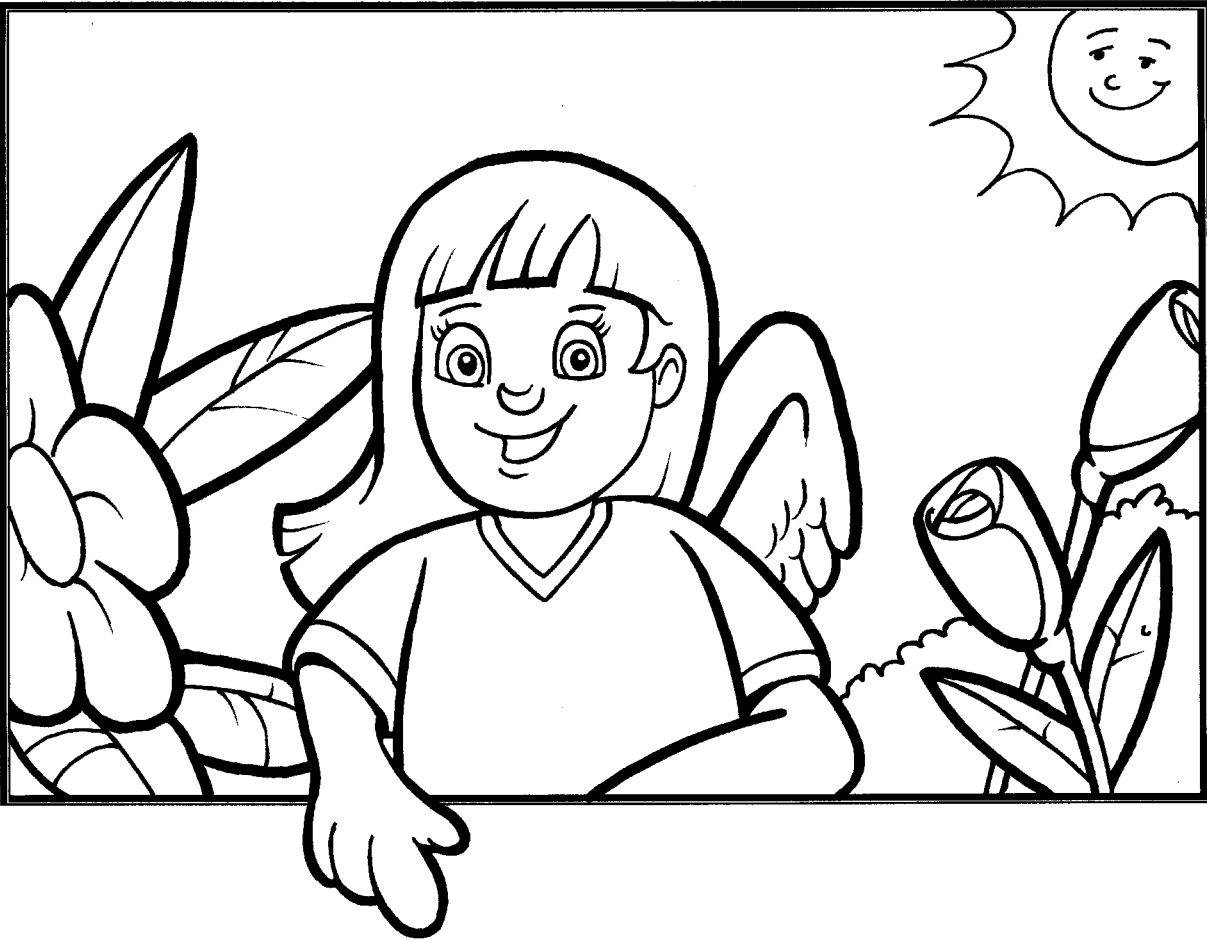

"AND I LOOKED AND, LO, A LAMB STOOD
ON MOUNT ZION, AND WITH HIM AN HUNDRED
FORTY AND FOUR THOUSAND, HAVING HIS
FATHER'S NAME
WRITTEN IN THEIR
FOREHEADS."

REVELATION 14:1

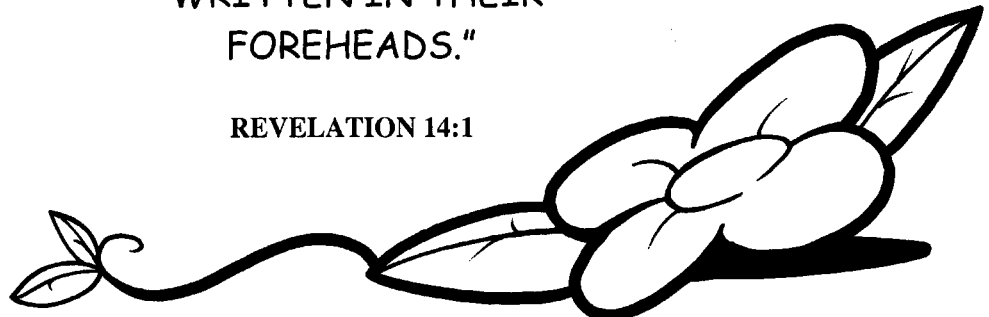

314. JESUS AND THE 144,000

(REVELATION 14:1-5)

MEMORY VERSE:

"These are the ones who follow the Lamb wherever He goes. These were redeemed from among men, being first fruits to God and to the Lamb." REVELATION 14:4

John writes...

CIRCLE THE CORRECT WORD:

1. "Then I looked, and behold, a Lamb standing on Mount Zion, and with Him one hundred and forty-four thousand, having His Father's name written on their (**FOREHEADS, FEET**)."
REVELATION 14:1

UNDERLINE THE CORRECT ANSWER:

2. "And I heard a voice from heaven, like..." REVELATION 14:2
- the voice of many waters
 - the voice of loud thunder
 - and I heard the sound of harpists playing their harps
 - all of the above

TRUE OR FALSE

3. "And they sang as it were a new song before the throne, before the four living creatures, and the elders..." REVELATION 14:3

TRUE OR FALSE

4. "...and no one could learn that song except the hundred and forty -four thousand who were redeemed from the earth." REVELATION 14:3

TRUE OR FALSE

CIRCLE THE CORRECT WORD:

5. "And in their mouth was found no (**FOOD, DECEIT**), for they are without fault before the throne of God." REVELATION 14:5

314. JESUS AND THE 144,000

(REVELATION 14:1-5)

O Z J I U T W B N B W B B S Q P Z R C A E R L Q G J P C Y A
 S N I T U H S G Y O T H R U R Z X U M E S M P Y P L U N Y L
 S O E A T T S C M I L J W E L F A U P Q Z J B C H M K U P Z
 R W C H T T I Z A R A Y D B J B M C M U P L N Z K P I K D K
 V H T L U R A H S F O N G H T X Z Q L T J P S A H B B S D V
 N Q C B D N G K V Y U K T U W K B N C V H O L K C E R U A M
 G I J Z D R D K Y H A P K Q K M T R S S D L P R O C Q N W N
 D L W Z Q W W R T B P G W T M Z P U G E C T H V V H I E Z B
 P H Y N C P R R E D A K I P L B Z K E T U P L Z N M J S C B
 K T J K U N E N K D D G U L U I F B Y K U N Q Y J B L B P D
 S Y T O J K D O W F F P M J G Z V I U N S R U E L I J T Y V
 P O N B K B E I L B Y O S B C F F F W B Y A I H D V V I E W
 P A A H S C E Z W E S P R J S Z H W I Y J P C Z R M R D J Z
 R V S F M D M T W H R S F T V D N L A Z G L C C Z T L L R C
 B C L V J W E N Z A M O O H Y B A J C A A Y M S B O R E L O
 O A P I T K D U H T U T E T U F E E L B K M R G H Q K I P M
 S D O G A I A O O L B W P J B D O B H U R T B E Y V J A P L
 L L U O A E F M A U S I K Y N K E U P E B F B I A U S K B R
 K O T S U P U E K W E H J R H B M B R E R H G F E G F Q B P
 W Z N N T I T N U Q L J F S R E T A W T N O B L M B Q Y D E
 V M D H E I O C N N J A Y D B U J K A D H D F B B D V R T N
 J F R I N Y U V U I M D M C A Y Q J I K Y O I K Z O B B P I
 B M A U Q B M R D S G U T B U E V W E G N R B M U N R T G V
 W Q Z A X B J C F V O O W G V E E U Y C M S V S I Z B P B J
 E S E F N P K C L T V L U S A J V M A M Q M S I A F I B A B
 L Q M F A P G H U U S O G Q E A V B Q N P C M U V N U Z V J
 V V D T Y Y H R F U S R H U I V L Y A Q L U K B O N D O F Z
 D P W Q Q F G E L A P U I M S K A R O R J R I W I B Q V R P
 D B Q H U O D M Y D T I B F G U I T Y U D S R V C A H L F Y
 Z Q X A Q J V Q H D W I V J J O L T E M D J K K E D C C Y T

BEHOLD
 FIRST FRUITS
 FOREHEADS
 GOD
 HARPS
 ONE HUNDRED FORTY-FOUR THOUSAND

MOUNT ZION
 WATERS
 REDEEMED
 THUNDER
 VOICE
 LAMB



314. JESUS AND THE 144,000

(REVELATION 14:1-5)

MEMORY VERSE:

"These are the ones who follow the Lamb wherever He goes. These were redeemed from among men, being first fruits to God and to the Lamb." REVELATION 14:4

John writes...

FILL IN THE BLANK:

1. "Then I looked, and behold, a Lamb standing on Mount Zion, and with Him one hundred and forty-four thousand, having His Father's name written on their _____."
REVELATION 14:1

UNDERLINE THE CORRECT ANSWER:

2. "And I heard a voice from heaven, like..." REVELATION 14:2
- a. the voice of many waters
 - b. the voice of loud thunder
 - c. and I heard the sound of harpists playing their harps
 - d. all of the above

TRUE OR FALSE

3. "And they sang as it were a new song before the throne, before the four living creatures, and the elders..." REVELATION 14:3
TRUE OR FALSE
4. "...and no one could learn that song except the hundred and forty -four thousand who were redeemed from the earth." REVELATION 14:3
TRUE OR FALSE

FILL IN THE BLANK:

5. "And in their mouth was found no _____, for they are without fault before the throne of God." REVELATION 14:5

314. JESUS AND THE 144,000 (REVELATION 14:1-5)

O Z J I U T W B N B W B B S Q P Z R C A E R L Q G J P C Y A
 S N I T U H S G Y O T H R U R Z W U M E S M P Y P L U N Y L
 S O E A T T S C M I L J W E L F A U P Q Z J B C H M K U P Z
 R W C H T T I Z A R A Y D B J B M C M U P L N Z K P I K D K
 V H T L U R A H S F O N G H T B Z Q L T J P S A H B B S D V
 N Q C B D N G K V Y U K T U W K B N C V H O L K C E R U A M
 G I J Z D R D K Y H A P K Q K M T R S S D L P R O C Q N W N
 D L W Z Q W W R T B P G W T M Z P U G E C T H V V H I E Z B
 P H Y N C P R R E D A K I P L B Z K E T U P L Z N M J S C B
 K T J K U N E N K D D G U L U I F B Y K U N Q Y J B L B P D
 S Y T O J K D O W F F P M J G Z V I U N S R U E L I J T Y V
 P O N B K B E I L B Y O S B C F F F W B Y A I H D V V I E W
 P A A H S C E Z W E S P R J S Z H W I Y J P C Z R M R D J Z
 R V S F M D M T W H R S F T V D N L A Z G L C C Z T L L R C
 B C L V J W E N Z A M O O H Y B A J C A A Y M S B O R E L O
 O A P I T K D U H T U T E T U F E E L B K M R G H Q K I P M
 S D O G A I A O O L B W P J B D O B H U R T B E Y V J A P L
 L L U O A E F M A U S I K Y N K E U P E B F B I A U S K B R
 K O T S U P U E K W E H J R H B M B R E R H G F E G F Q B P
 W Z N N T I T N U Q L J F S R E T A W T N O B L M B Q Y D E
 V M D H E I O C N N J A Y D B U J K A D H D F B B D V R T N
 J F R I N Y U V U I M D M C A Y Q J I K Y O I K Z O B B P I
 B M A U Q B M R D S G U T B U E V K E G N R U M U N R T G V
 W Q Z A B B J C F V O O W G V E E U Y C M S V S I Z B P B J
 E S E F N P K C L T V L U S A J V M A M Q M S I A F I K A B
 L Q M F A P G H U U S O G Q E A V B Q N P C M U V N U Z V J
 V V D T Y Y H R F U S R H U I V L Y A Q L U K B O N D O F Z
 D P W Q Q F G E L A P U I M S K A R O R J R I W I B Q V R P
 D B Q H U O D M Y D T I B F G U I T Y U D S R V C A H L F Y
 Z Q B A Q J V Q H D W I V J J O L T E M D J K K E D C C Y T

BEHOLD
 FIRST FRUITS
 FOREHEADS
 GOD
 HARPS
 ONE HUNDRED FORTY-FOUR THOUSAND

MOUNT ZION
 WATERS
 REDEEMED
 THUNDER
 VOICE
 LAMB

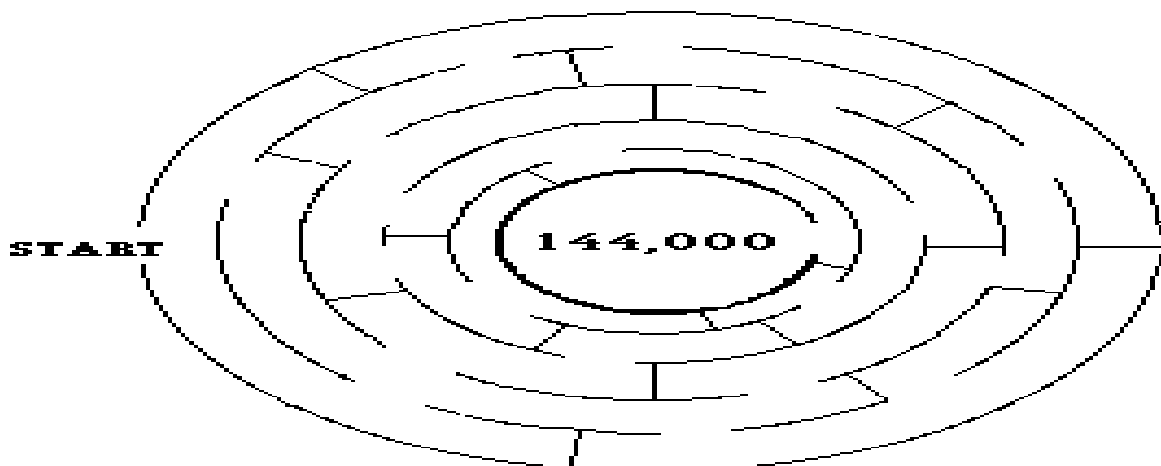

314. JESUS AND THE 144,000 (REVELATION 14:1-5)

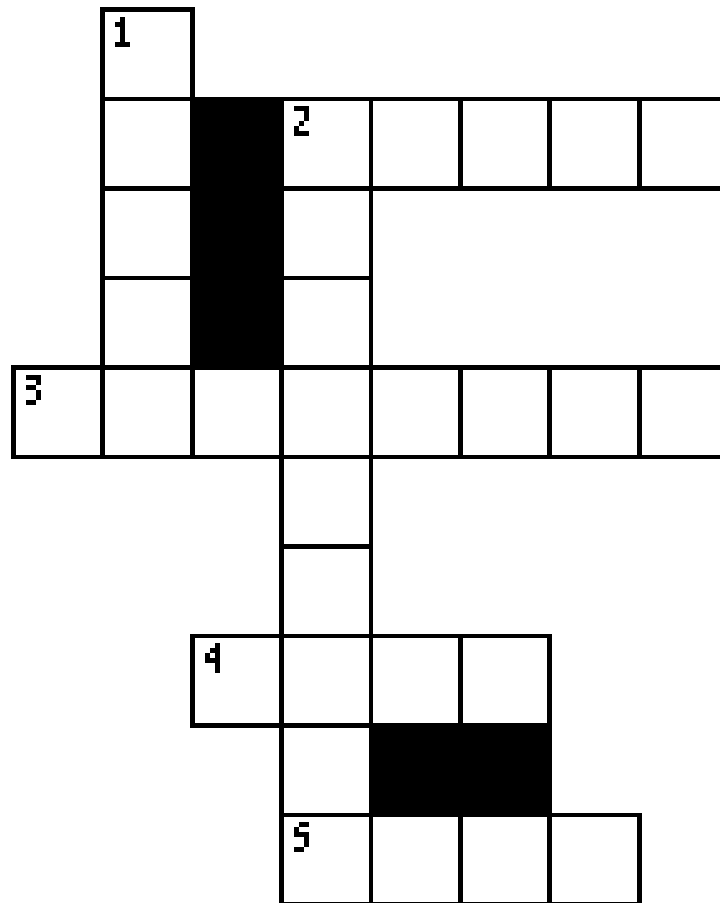

- 2 DOWN "Then I looked, and behold, a Lamb standing on Mount Zion, and with Him one hundred and forty-four thousand, having His Father's name written on their ____." **REVELATION 14:1**
- 1 DOWN "And I heard a ____ from heaven, like the voice of many waters, and the voice of loud thunder. And I heard the sound of harpists playing their harps." **REVELATION 14:2**
- 5 ACROSS "And they sang as it were a new ____ before the throne, before the four living creatures, and the elders..." **REVELATION 14:3**
- 3 ACROSS "...and no one could learn that song except the hundred and forty-four thousand who were ____ from the earth." **REVELATION 14:3**
- 4 ACROSS "These are the ones who follow the ____ wherever He goes. These were redeemed from among men, being first fruits to God and to the Lamb." **REVELATION 14:4**
- 2 ACROSS "And in their mouth was found no deceit, for they are without ____ before the throne of God." **REVELATION 14:5**

Bible Story 315

THE SEVEN BOWLS

Revelation 15:7-16:21



The angels pour out the bowls on the earth.
REVELATION 15:7-16:21

315. THE SEVEN BOWLS

(REVELATION 15:7-16:21)

MEMORY VERSE:

"And I heard the angel of the waters saying: 'You are righteous, O Lord, the One who is and who was and who is to be, because You have judged these things.' " REVELATION 16:5

TRUE OR FALSE:

1. "Then one of the four living creatures gave to the seven angels seven golden bowls full of the wrath of God who lives forever and ever." **REVELATION 15:7**
TRUE OR FALSE

CIRCLE THE CORRECT WORD:

2. "Then I heard a loud voice from the temple saying to the seven angels, 'Go and pour out the bowls of the (PEACE, WRATH) of God on the earth.' " **REVELATION 16:1**

TRUE OR FALSE:

3. "So the first went and poured out his bowl upon the earth, and a foul and loathsome sore came upon the men who had the mark of the beast and those who worshiped his image." **REVELATION 16:2**
TRUE OR FALSE

4. Then the second angel poured out his bowl on the sea, and it became seaweed... **REVELATION 16:3**
TRUE OR FALSE

5. "Then the third angel poured out his bowl on the rivers and springs of water, and they became blood." **REVELATION 16:4**
TRUE OR FALSE

CIRCLE THE CORRECT WORDS:

6. "Then the fourth angel poured out his bowl on the (MOON, SUN), and power was given to him to scorch men with fire." **REVELATION 16:8**
7. "And men were scorched with great (HEAT, COLDNESS)..." **REVELATION 16:9**
8. "Then the fifth angel poured out his bowl on the throne of the beast, and his kingdom became full of (MUD, DARKNESS)." **REVELATION 16:10**
9. "Then the sixth angel poured out his bowl on the great river (NILE, EUPHRATES), and its water was dried up, so that the way of the kings from the east might be prepared." **REVELATION 16:12**
10. "Then the seventh angel poured out his bowl into the (SAND, AIR), and a loud voice came out of the temple of heaven, from the throne, saying, 'It is done!' " **REVELATION 16:17**

315. THE SEVEN BOWLS

(REVELATION 15:7-16:21)

G	K	T	S	K	F	G	B	E	O	G	E	C	K	G
O	N	E	B	B	R	S	O	D	N	F	A	N	R	H
L	A	U	D	L	K	I	E	F	O	Y	Y	A	A	T
D	S	M	S	P	O	K	U	V	I	G	P	I	M	R
E	M	T	E	H	P	O	R	P	E	S	L	A	F	A
N	T	Z	T	P	K	E	D	H	J	N	A	Z	B	E
B	N	J	B	R	R	W	R	A	T	H	G	S	R	A
O	E	S	B	I	I	U	V	I	J	Q	U	S	P	M
W	P	M	F	U	Y	V	Z	L	Y	D	E	O	J	M
L	E	B	G	Z	S	L	E	G	N	A	S	R	P	A
S	R	E	L	P	M	E	T	R	T	C	U	E	Q	O
Z	F	R	O	G	S	A	A	P	S	M	H	N	B	K
L	I	V	I	N	G	C	R	E	A	T	U	R	E	S
K	O	P	E	V	R	V	U	T	H	P	A	C	Q	C
F	A	C	I	D	E	G	D	U	J	O	E	Z	F	Y

ANGELS
BLOOD
EARTH
FALSE PROPHET
FIRE
FROGS

GOD
GOLDEN BOWLS
HAIL
JUDGED
LIVING CREATURES

MARK
PLAGUES
REPENT
RIVERS
SEA

SEVEN
SORE
SUN
TEMPLE
WRATH

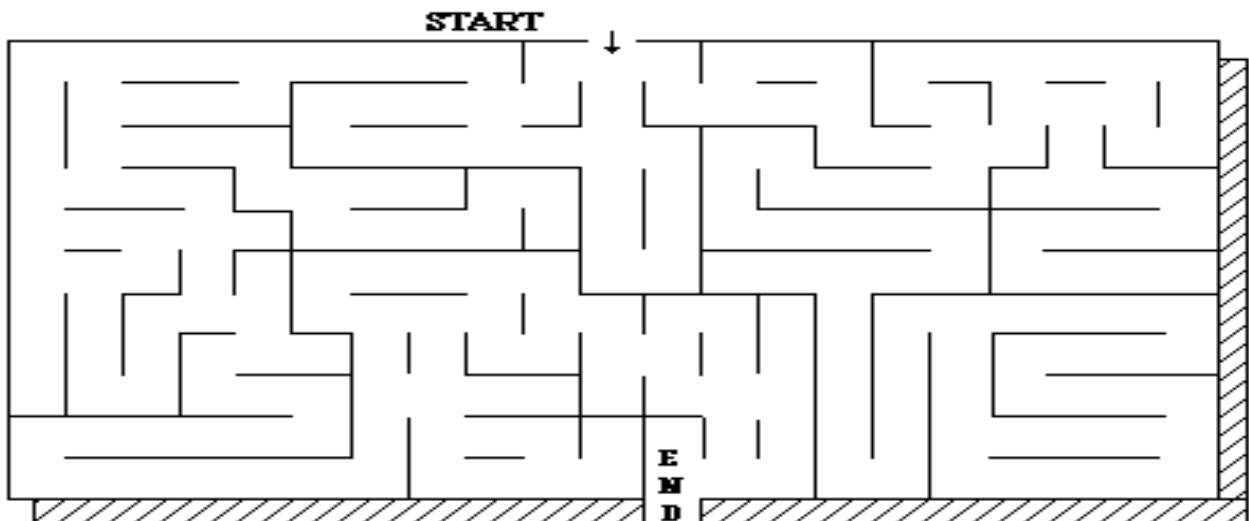

315. THE SEVEN BOWLS

(REVELATION 15:7-16:21)

MEMORY VERSE:

"And I heard the angel of the waters saying: 'You are righteous, O Lord, the One who is and who was and who is to be, because You have judged these things.' " REVELATION 16:5

TRUE OR FALSE:

1. "Then one of the four living creatures gave to the seven angels seven golden bowls full of the wrath of God who lives forever and ever." **REVELATION 15:7**
TRUE OR FALSE

FILL IN THE BLANK:

2. "Then I heard a loud voice from the temple saying to the seven angels, 'Go and pour out the bowls of the _____ of God on the earth.' " **REVELATION 16:1**

TRUE OR FALSE:

3. "So the first went and poured out his bowl upon the earth, and a foul and loathsome sore came upon the men who had the mark of the beast and those who worshiped his image." **REVELATION 16:2**
TRUE OR FALSE
4. Then the second angel poured out his bowl on the sea, and it became seaweed... **REVELATION 16:3**
TRUE OR FALSE
5. "Then the third angel poured out his bowl on the rivers and springs of water, and they became blood." **REVELATION 16:4**
TRUE OR FALSE

FILL IN THE BLANKS:

6. "Then the fourth angel poured out his bowl on the _____, and power was given to him to scorch men with fire." **REVELATION 16:8**
7. "And men were scorched with great _____..." **REVELATION 16:9**
8. "Then the fifth angel poured out his bowl on the throne of the beast, and his kingdom became full of _____." **REVELATION 16:10**
9. "Then the sixth angel poured out his bowl on the great river _____, and its water was dried up, so that the way of the kings from the east might be prepared." **REVELATION 16:12**
10. "Then the seventh angel poured out his bowl into the _____, and a loud voice came out of the temple of heaven, from the throne, saying, 'It is done!' " **REVELATION 16:17**

315. THE SEVEN BOWLS

(REVELATION 15:7-16:21)

S M R Q V P J P M H P M B H W V K N K T L S F P U
 I S G O R F T I A G Y S A A V A D R K M B L O O D
 L H Q E Q Z N Q Z E B Z C H M R D Y A O P M R T H
 S L R T Z C E D S U D F W Z F S I Y T E M B K O A
 J O I A U C P J H W R P J Y S R E V W M C P K N E
 S D P Q A Q E Q M D C G B N W L O U E T E M P L E
 F S H F N I R R B W G K K J U W K D G R C C Y I C
 F R E T E H P O R P E S L A F J Q J L A S D R J N
 O E Z V M W T I S Y R B O T D U K I A B L T G J A
 P U I H E Z E L V P G U I P S O L P P N V P I Y I
 E W V P G N I L S Z N K T L J E D E G D U J K T Z
 E J V J F A J S O U G C E J H P W T P O Z B U H S
 A N B T H K Z T J W N U J C Q T K V A B K B A G N
 R S Q B H K Z F J B Z M K V O C I R B U F G V F C
 T Z S E R U T A E R C G N I V I L F V S K E B Y Z
 H K Y I A Q K A E M J D K T E S J E Q L S F O Q B
 O B E A W J C Y A W P L P W W C S J D W S I I D R
 O Z L M B B T Y D U N S Z H E H U O V O M E U R P
 C F N B P B I O W O U V Y P B U E U S B O K A C E
 F H W T E R O F L F G R Y J K S L E G N A B V M J
 M A R K O F T H E B E A S T S E A G M E A P Z P P
 K N A Y S B T V Z I O C O H U C V F C D T P A O Q
 B G T L G K A B B B F M J Q H N D K Z L M U U E B
 Y B H I D E N S P G L L F O P Q Q D L O Z Z E A Q
 N G V O E F R V J Y L B A A E L E B U G J V F Y F

- | | | | |
|---------------|------------------|-------------------|--------|
| ANGELS | GOD | MARK OF THE BEAST | SEVEN |
| BLOOD | GOLDEN BOWLS | PLAGUES | SORE |
| EARTH | HAIL | REPENT | SUN |
| FALSE PROPHET | JUDGED | RIVERS | TEMPLE |
| FIRE | LIVING CREATURES | SEA | WRATH |
| FROGS | | | |

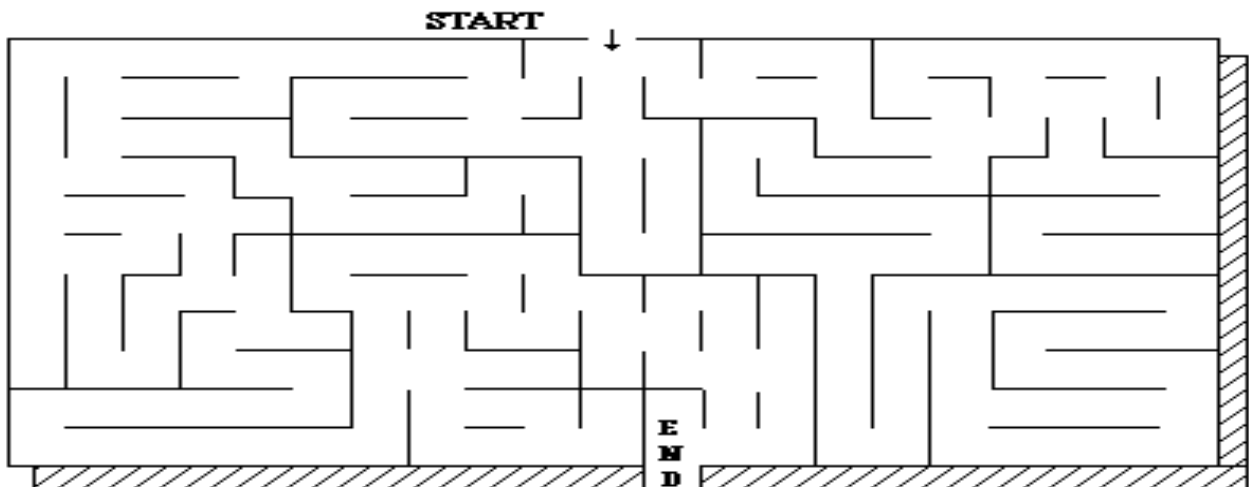

315. THE SEVEN BOWLS

(REVELATION 15:7-16:21)

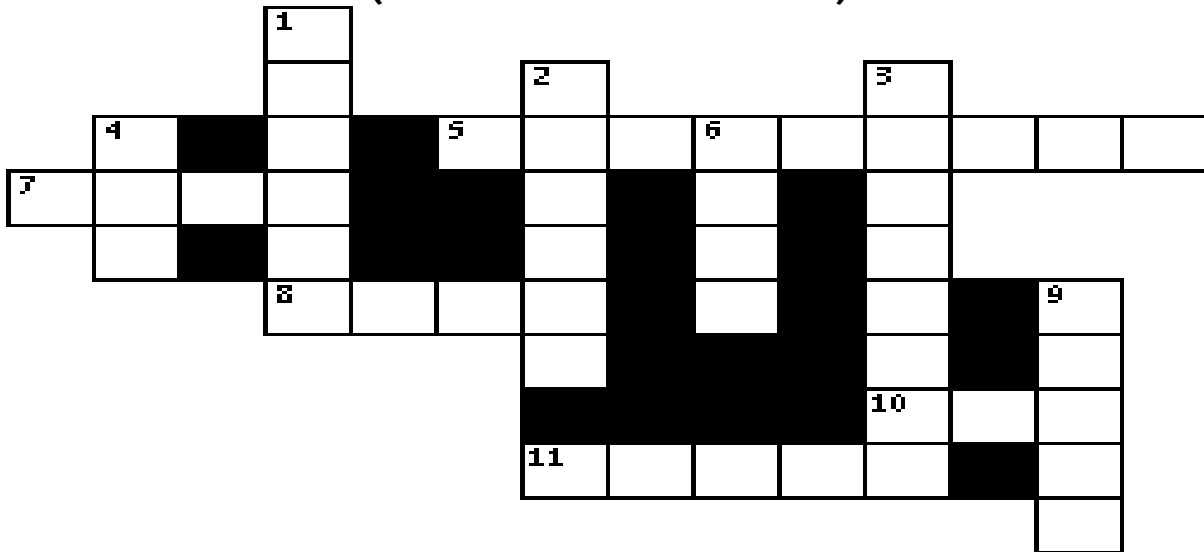

- 11 ACROSS "Then one of the four living creatures gave to the seven angels seven golden _____ full of the wrath of God who lives forever and ever." **REVELATION 15:7**
- 9 DOWN "Then I heard a loud voice from the temple saying to the seven angels, 'Go and pour out the bowls of the _____ of God on the earth.'" **REVELATION 16:1**
- 8 ACROSS "So the first went and poured out his bowl upon the earth, and a foul and loathsome _____ came upon the men who had the mark of the beast and those who worshiped his image." **REVELATION 16:2**
- 10 ACROSS "Then the second angel poured out his bowl on the _____, and it became blood..." **REVELATION 16:3**
- 1 DOWN "Then the third angel poured out his bowl on the _____ and springs of water, and they became blood." **REVELATION 16:4**
- 2 DOWN "And I heard the angel of the waters saying: 'You are righteous, O Lord, the One who is and who was and who is to be, because You have _____ these things.'" **REVELATION 16:5**
- 7 ACROSS "Then the fourth angel poured out his bowl on the sun, and power was given to him to scorch men with _____." **REVELATION 16:8**
- 6 DOWN "And men were scorched with great _____..." **REVELATION 16:9**
- 3 DOWN "Then the fifth angel poured out his bowl on the throne of the beast, and his kingdom became full of _____." **REVELATION 16:10**
- 5 ACROSS "Then the sixth angel poured out his bowl on the great river _____, and its water was dried up, so that the way of the kings from the east might be prepared." **REVELATION 16:12**
- 4 DOWN "Then the seventh angel poured out his bowl into the _____, and a loud voice came out of the temple of heaven, from the throne, saying, 'It is done!'" **REVELATION 16:17**

Bible Story 316

**THE
FALL OF
BABYLON**

Revelation 18:1-24

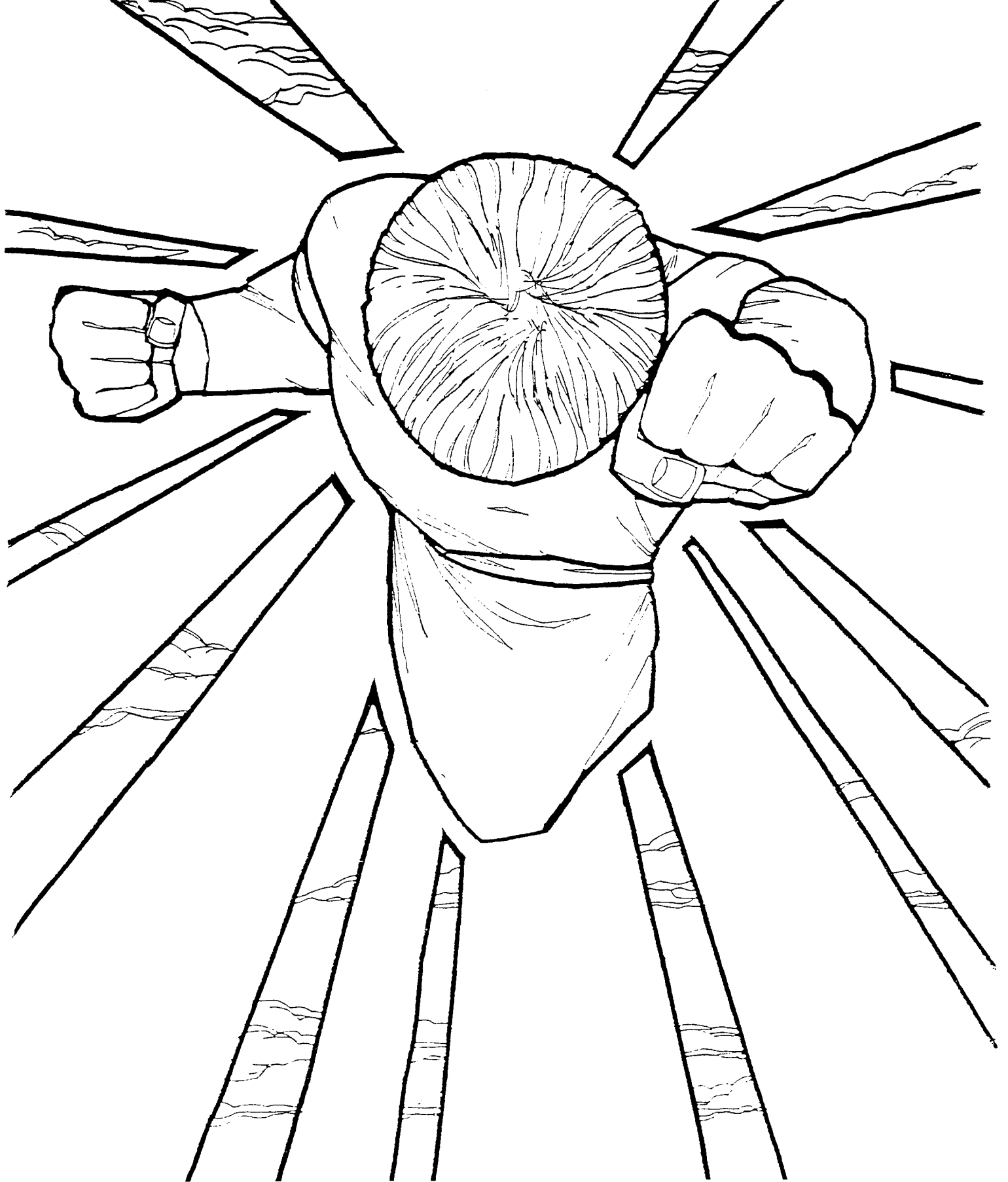

John "saw another angel coming down from heaven, having great authority,
and the earth was illuminated with his glory."

REVELATION 18:1

316. THE FALL OF BABYLON

(REVELATION 18:1-24)

MEMORY VERSE:

"...Alas, alas, that great city Babylon, that mighty city! For in one hour your judgment has come."
REVELATION 18:10

TRUE OR FALSE:

1. "After these things I saw another angel coming down from heaven, having great authority, and the earth was illuminated with his glory." **REVELATION 18:1**
TRUE OR FALSE

CIRCLE THE CORRECT WORDS:

2. "And he cried mightily with a loud voice, saying, '(EGYPT, BABYLON) the great is fallen, is fallen!...' "
REVELATION 18:2
3. "For her (SONGS, SINS) have reached to heaven, and God has remembered her iniquities."
REVELATION 18:5

TRUE OR FALSE:

4. "Therefore her plagues will come in one day- death and mourning and famine. And she will be utterly burned with fire, for strong is the Lord God who judges her." **REVELATION 18:8**
TRUE OR FALSE

CIRCLE THE CORRECT WORD:

5. "...Alas, alas, that great city Babylon, that mighty city! For in one (HOUR, YEAR) your judgment has come."
REVELATION 18:10

TRUE OR FALSE:

6. "The merchants of these things, who became rich by her, will stand at a distance for fear of her torment, weeping and wailing." **REVELATION 18:15**
TRUE OR FALSE

CIRCLE THE CORRECT WORD:

7. " 'For in one hour such great riches came to nothing.' And every (SHIPMASTER, STOWAWAY), all who travel by ship, sailors, and as many as trade on the sea, stood at a distance." **REVELATION 18:17**

UNDERLINE THE CORRECT ANSWER:

8. "Then a mighty angel took up a stone like a great millstone and threw it into the sea, saying, 'Thus with violence the great city of Babylon shall be thrown down, and...'" **REVELATION 18:21**
- a. shall not be found anymore
 - b. shall be found again later
 - c. neither of these answers

316. THE FALL OF BABYLON

(REVELATION 18:1-24)

M B A B Y L O N Y F Q I O F E
O B U R N E D A N G E L N H Y
U G Y S N I S M O K E J E E B
R A U P E J I G R J C J H T T
N M S T N A H C R E M U O A I
I M D G D M Z R T S D D U L O
N A Y H E A V E N G Y G R O N
G E G C B V T H E R R M A S E
J R E T S A M P I H S E G E L
P I E N I M A F U A W N Q D L
Q F S E U G A L P R Q T D P A
B O T J Y W M U A S T E E W F
G R E A T C I T Y F B E A U W
Q K I N K Z H V S N W F T I A
F C I H K F G Y S T K S H K E

ANGEL	FALLEN	JUDGMENT	SHIPMASTER
BABYLON	FAMINE	MERCHANTS	SINS
BURNED	FIRE	MOURNING	SMOKE
DEATH	GREAT CITY	ONE HOUR	WEEP
DESOLATE	HEAVEN	PLAGUES	WRATH

316. THE FALL OF BABYLON

(REVELATION 18:1-24)

MEMORY VERSE:

"...Alas, alas, that great city Babylon, that mighty city! For in one hour your judgment has come."
REVELATION 18:10

TRUE OR FALSE:

1. "After these things I saw another angel coming down from heaven, having great authority, and the earth was illuminated with his glory." **REVELATION 18:1**
TRUE OR FALSE

FILL IN THE BLANKS:

2. "And he cried mightily with a loud voice, saying, ' _____ the great is fallen, is fallen!...' "
REVELATION 18:2
3. "For her _____ have reached to heaven, and God has remembered her iniquities."
REVELATION 18:5

TRUE OR FALSE:

4. "Therefore her plagues will come in one day- death and mourning and famine. And she will be utterly burned with fire, for strong is the Lord God who judges her." **REVELATION 18:8**
TRUE OR FALSE

FILL IN THE BLANK:

5. "...Alas, alas, that great city Babylon, that mighty city! For in one _____ your judgment has come."
REVELATION 18:10

TRUE OR FALSE:

6. "The merchants of these things, who became rich by her, will stand at a distance for fear of her torment, weeping and wailing." **REVELATION 18:15**
TRUE OR FALSE

FILL IN THE BLANK:

7. " 'For in one hour such great riches came to nothing.' And every _____,
all who travel by ship, sailors, and as many as trade on the sea, stood at a distance." **REVELATION 18:17**

UNDERLINE THE CORRECT ANSWER:

8. "Then a mighty angel took up a stone like a great millstone and threw it into the sea, saying, 'Thus with violence the great city of Babylon shall be thrown down, and...'" **REVELATION 18:21**
- a. shall not be found anymore
 - b. shall be found again later
 - c. neither of these answers

316. THE FALL OF BABYLON

(REVELATION 18:1-24)

V I P F I B L W Z M K J Q P K D T E K B V D Z Y I
 Q S E U G A L P J D W C O T I J W M S P Z C X G Z
 T O Z J Q S Z U P E K V E C J J L B M P A M R T T
 A V C T D V B F E L P T W S O E U N O U U P P I M
 Q Q C E J M P P N S Z W E C N I T D A Z E O J I G
 F Z A N G E L I U V Y H B H E P A A G V F E P P G
 H B Q J Q A J B O R Y P K U H T P O L M P A Q G R
 P U A G N I N R U O M J S E O V P B T O E Y B C H
 J A I B R Z H G F C O H U C U R A S M F S N Q J U
 T N W Z Y S G Y L M J Q H N R F B M Z R T E T N V
 B M Z Z E L E P L L F O P Q S E V O J K O U D H Y
 F G K R I H O Y M B A A S L U D Q K S K N H F E Y
 A F I K L M U N S B H W E H E J D E M Y I A G D R
 M F K C S B W B Z A A V V N I O V U B R J E A B T
 I H S T N A H C R E M M R K E P S L P G J C M Y E
 N A Q T T S D D F C H U A D A U M P C I Y N M K U
 E W J I F V W R P W B F R D V G M A D K D A A K S
 I B B O A O Y C G J Z S L O D F C M S U T E O J S
 A P B T Y J P G K U Y W W S Q K Z N T T H I A M F
 M E R A Y J Z R B K N U I K E D E C B A E Z K T J
 G R E A T C I T Y O J N J Q N L L C B V G R C V H
 B S B N O E W G U I S D U K L B U V G H T A R W S
 T G K R F A B N K T T S O A R K T Z E B F S Y W G
 Y D N E V A E H C E P J F L Y K M K I O Y N U Z R
 L E E P V W M G U J L H E W Y A O F K U Q C D F A

ANGEL	FALLEN	JUDGMENT	SHIPMASTER
BABYLON	FAMINE	MERCHANTS	SINS
BURNED	FIRE	MOURNING	SMOKE
DEATH	GREAT CITY	ONE HOUR	WEEP
DESOLATE	HEAVEN	PLAGUES	WRATH

316. THE FALL OF BABYLON

(REVELATION 18:1-24)

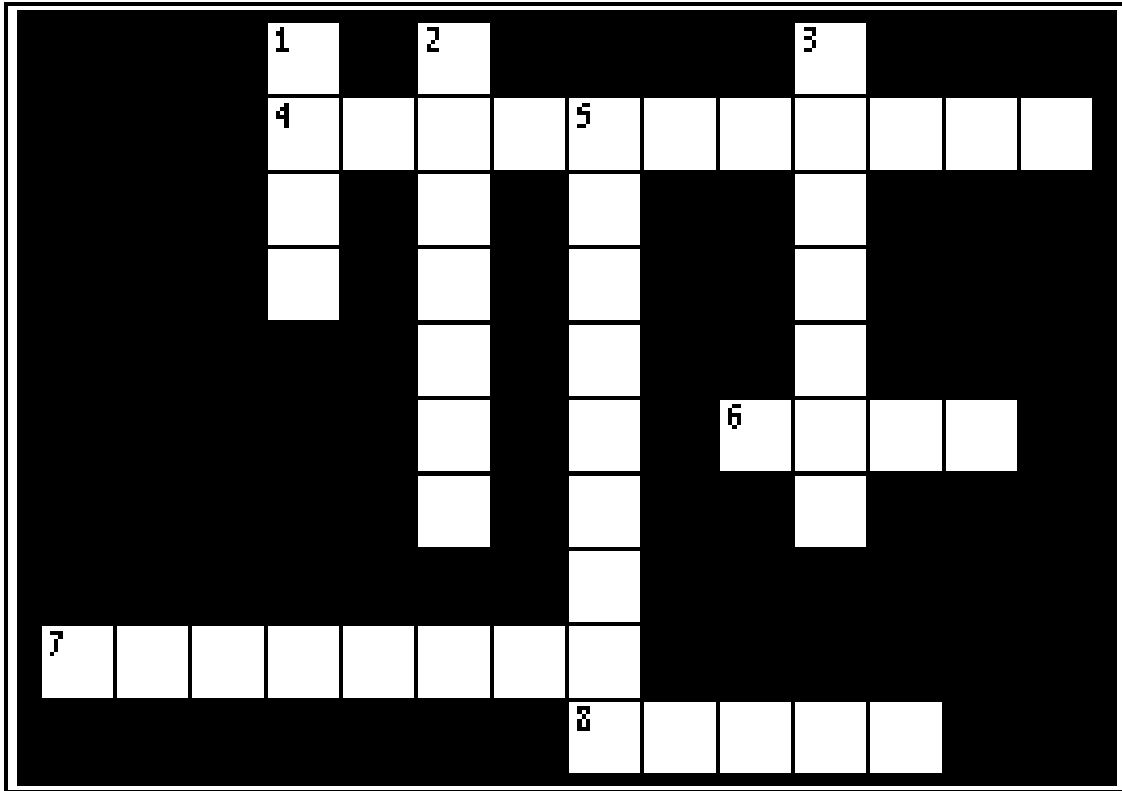

- 4 ACROSS "After these things I saw another angel coming down from heaven, having great authority, and the earth was _____ with his glory." **REVELATION 18:1**
- 3 DOWN "And he cried mightily with a loud voice, saying, ' _____ the great is fallen, is fallen!...' " **REVELATION 18:2**
- 1 DOWN "For her _____ have reached to heaven, and God has remembered her iniquities." **REVELATION 18:5**
- 2 DOWN "Therefore her _____ will come in one day- death and mourning and famine. And she will be utterly burned with fire, for strong is the Lord God who judges her." **REVELATION 18:8**
- 7 ACROSS "...Alas, alas, that great city Babylon, that mighty city! For in one hour your _____ has come." **REVELATION 18:10**
- 5 DOWN "The _____ of these things, who became rich by her, will stand at a distance for fear of her torment, weeping and wailing." **REVELATION 18:15**
- 6 ACROSS "'For in one _____ such great riches came to nothing.' And every shipmaster, all who travel by ship, sailors, and as many as trade on the sea, stood at a distance." **REVELATION 18:17**
- 8 ACROSS "Then a mighty angel took up a _____ like a great millstone and threw it into the sea, saying, 'Thus with violence the great city of Babylon shall be thrown down, and shall not be found anymore.' " **REVELATION 18:21**

Bible Story 317

**THE
MARRIAGE SUPPER
OF THE LAMB**

Revelation 19:6-9

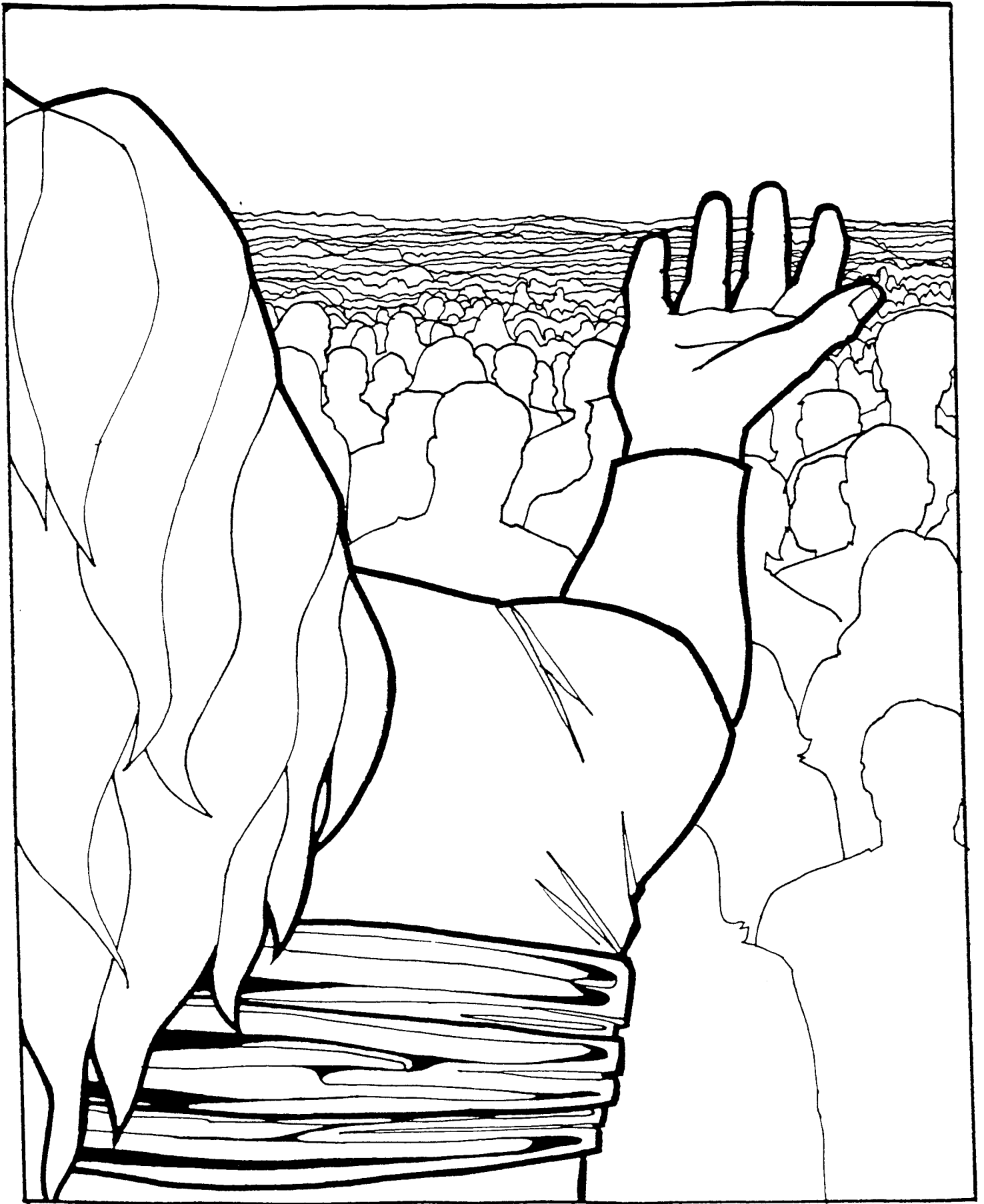

The Marriage Supper of the Lamb.
REVELATION 19:6-9

317. THE MARRIAGE SUPPER OF THE LAMB

(REVELATION 19:6-9)

MEMORY VERSE:

"After these things I heard a loud voice of a great multitude in heaven, saying, 'Alleluia! Salvation and glory and honor and power belong to the Lord our God!' "
REVELATION 19:1

John writes...

CIRCLE THE CORRECT WORDS:

1. "And I heard, as it were, the voice of a great multitude, as the sound of many (**WATERS, SINGERS**) and as the sound of mighty (**MEN, THUNDERINGS**), saying, 'Alleluia! For the Lord God Omnipotent reigns!' " **REVELATION 19:6**

TRUE OR FALSE:

2. "Let us be glad and rejoice and give Him glory, for the marriage of the Lamb has come, and His wife has made herself ready." **REVELATION 19:7**
TRUE OR FALSE

CIRCLE THE CORRECT WORD:

3. "And to her it was granted to be arrayed in fine linen, clean and bright, for the fine linen is the righteous acts of the (**SAINTS, ANGELS**)." **REVELATION 19:8**

TRUE OR FALSE:

4. "Then he said to me, 'Write: "Blessed are those who are called to the marriage supper of the Lamb!" "... " **REVELATION 19:9**
TRUE OR FALSE

CIRCLE THE CORRECT WORD:

5. "These are the (**TRUE, NEW**) sayings of God." **REVELATION 19:9**

317. THE MARRIAGE SUPPER OF THE LAMB

(REVELATION 19:6-9)

A U E G O D L G V S L P P C U
 E I M Y G O S U P P E R K G V
 Z P H L B J P Y G Y K E R O E
 C N A M V S R E T A W Y N A M
 L D Y B S E F Q W B I U E W Z
 W S E P E G I D D L Q V N J E
 C C D R C A N O K E S F A C U
 A N U W I I E I A S S I I V U
 Z P T I O R L O R S O O I H I
 S C I F J R I K G E V U P Y B
 D B T E E A N P S D D H Q G Q
 G C L Y R M E Z A B E N F M B
 P B U R S G N I Y A S E U R T
 C P M E T Q V S U F Z I R H V
 V R Y D A E R T K B M A L B T

BLESSED
 FINE LINEN
 GLAD
 GOD
 LAMB

MANY WATERS
 MARRIAGE
 MULTITUDE
 READY
 REJOICE

SUPPER
 THUNDERINGS
 TRUE SAYINGS
 VOICE
 WIFE

THE MARRIAGE SUPPER OF THE LAMB

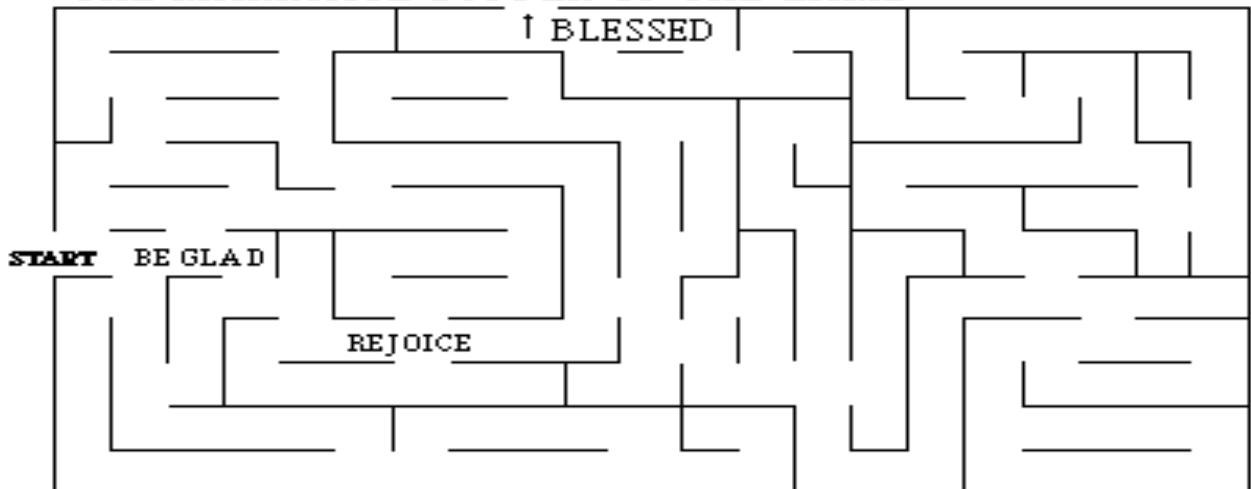

317. THE MARRIAGE SUPPER OF THE LAMB

(REVELATION 19:6-9)

MEMORY VERSE:

"After these things I heard a loud voice of a great multitude in heaven, saying, 'Alleluia! Salvation and glory and honor and power belong to the Lord our God!' "
REVELATION 19:1

John writes...

FILL IN THE BLANKS:

1. "And I heard, as it were, the voice of a great multitude, as the sound of many _____ and as the sound of mighty _____, saying, 'Alleluia! For the Lord God Omnipotent reigns!' " **REVELATION 19:6**

TRUE OR FALSE:

2. "Let us be glad and rejoice and give Him glory, for the marriage of the Lamb has come, and His wife has made herself ready." **REVELATION 19:7**
TRUE OR FALSE

FILL IN THE BLANK:

3. "And to her it was granted to be arrayed in fine linen, clean and bright, for the fine linen is the righteous acts of the _____." **REVELATION 19:8**

TRUE OR FALSE:

4. "Then he said to me, 'Write: "Blessed are those who are called to the marriage supper of the Lamb!" '..." **REVELATION 19:9**
TRUE OR FALSE

FILL IN THE BLANK:

5. "These are the _____ sayings of God." **REVELATION 19:9**

317. THE MARRIAGE SUPPER OF THE LAMB

(REVELATION 19:6-9)

K D A J P B O Q M Q W J J E A D B I S Y
 S Z L I U I B H J T K W K N S L O S M K
 P Z O C D T E A T M A N Y W A T E R S P
 P O E O T A H D A H I S G C V U I V U G
 R W G G T H F U U T E S H E C I O J E R
 B H Z T I L U U A T P I G V Y F R U B K
 O Q M C N A V N U T I A D C K L F U S G
 S I F J D B R T D R G T V C W S Y A E P
 L L A M B Z I R E E I L L H L G B D J S
 K L M W R D O T A R R G A U W N D D M O
 W F Q Y A E N D N M Y I B D M I F W G T
 V H I J Z S H D Q W B W N R W Y B T O W
 J T S N E S I Q B P B A G G Z A E L V I
 B Y Q T E E U C N N P F C E S S H A S H
 W O V N E L A U A K P U Z M O E T O P J
 E A P C M B I J Y B Y R H Q A U L A T D
 L V I A D Z F N Q C E T K E K R U P W U
 V O B S W N F K E A F O F N U T W A B O
 V S U P P E R S D N O I K Y N Y Q D H L
 D C Q L Q K T Y U D W M R M U H N Y J O

BLESSED
 FINE LINEN
 GLAD
 GOD
 LAMB

MANY WATERS
 MARRAIGE
 MULTITUDE
 READY
 REJOICE

SUPPER
 THUNDERINGS
 TRUE SAYINGS
 VOICE
 WIFE

THE MARRIAGE SUPPER OF THE LAMB

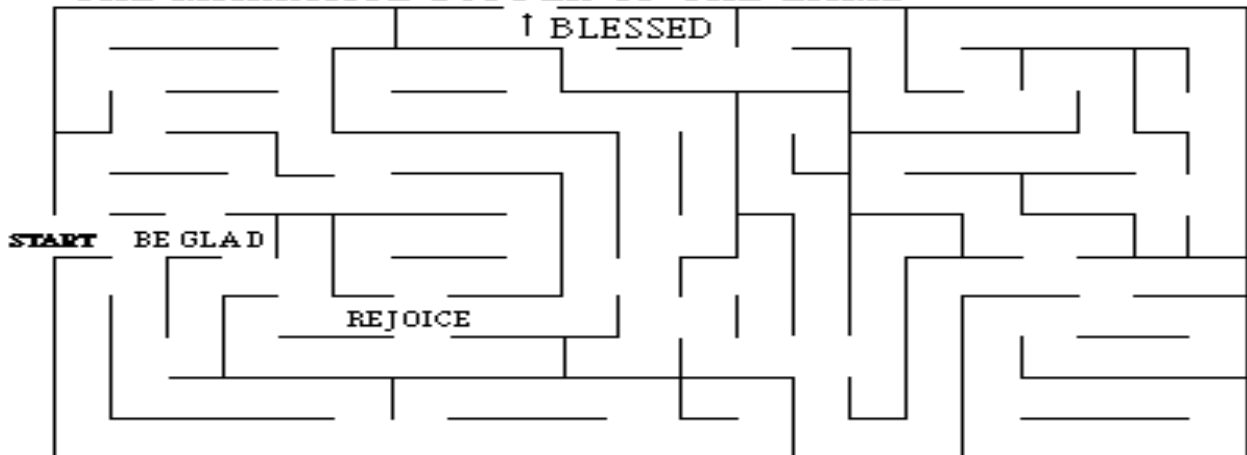

317. THE MARRIAGE SUPPER OF THE LAMB

(REVELATION 19:6-9)

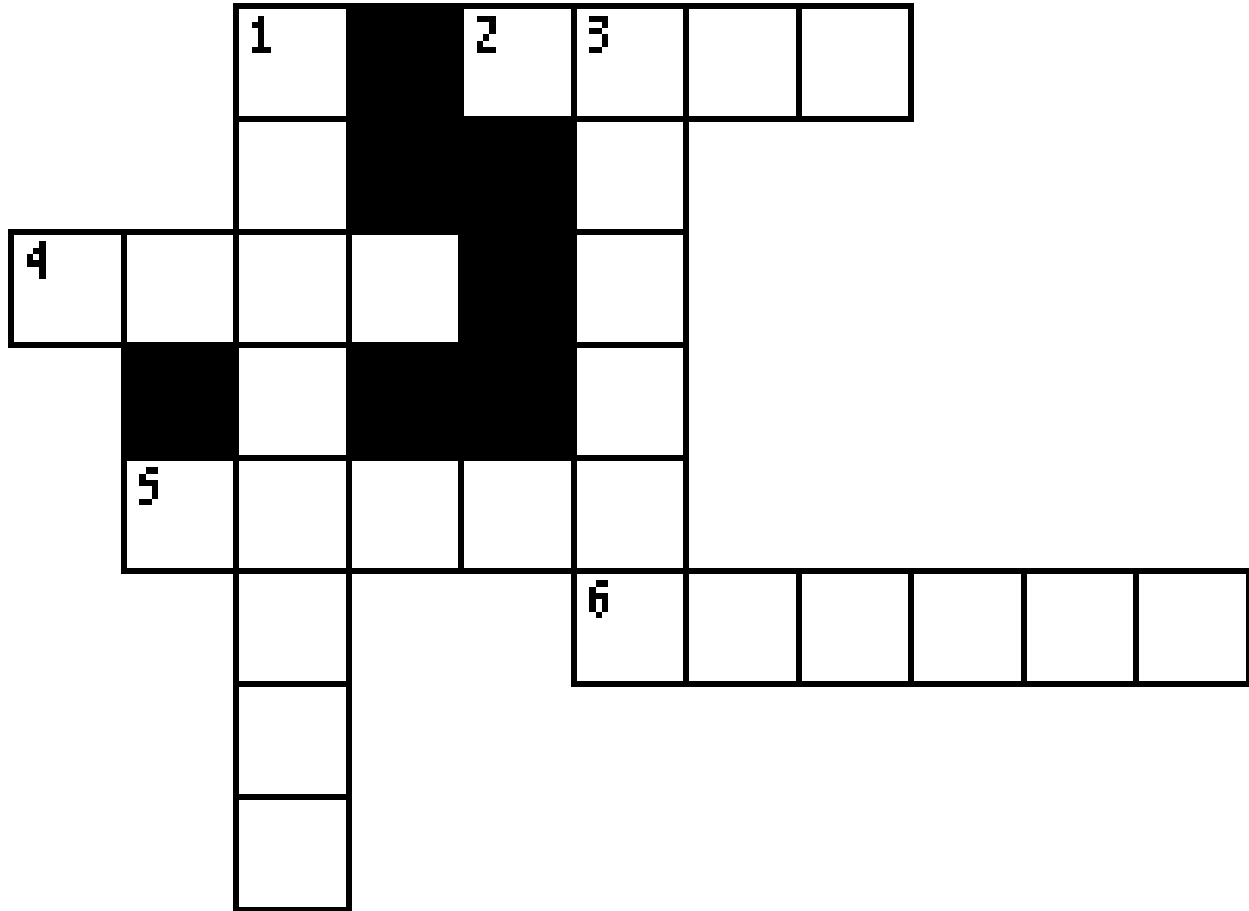

- 4 ACROSS "After these things I heard a loud voice of a great multitude in heaven, saying, 'Alleluia! Salvation and glory and honor and power belong to the _____ our God!' " **REVELATION 19:1**
- 3 DOWN "And I heard, as it were, the voice of a great multitude, as the sound of many waters and as the sound of mighty thunderings, saying, 'Alleluia! For the Lord God Omnipotent _____!' " **REVELATION 19:6**
- 1 DOWN "Let us be glad and rejoice and give Him glory, for the _____ of the Lamb has come, and His wife has made herself ready." **REVELATION 19:7**
- 5 ACROSS "And to her it was granted to be arrayed in fine _____, clean and bright, for the fine linen is the righteous acts of the saints." **REVELATION 19:8**
- 6 ACROSS "Then he said to me, 'Write: "Blessed are those who are called to the marriage _____ of the Lamb!" '..." **REVELATION 19:9**
- 2 ACROSS "These are the _____ sayings of God." **REVELATION 19:9**

Bible Story 318

**CHRIST DEFEATS
THE ARMIES
OF THE BEAST**

REVELATION 19:11-21

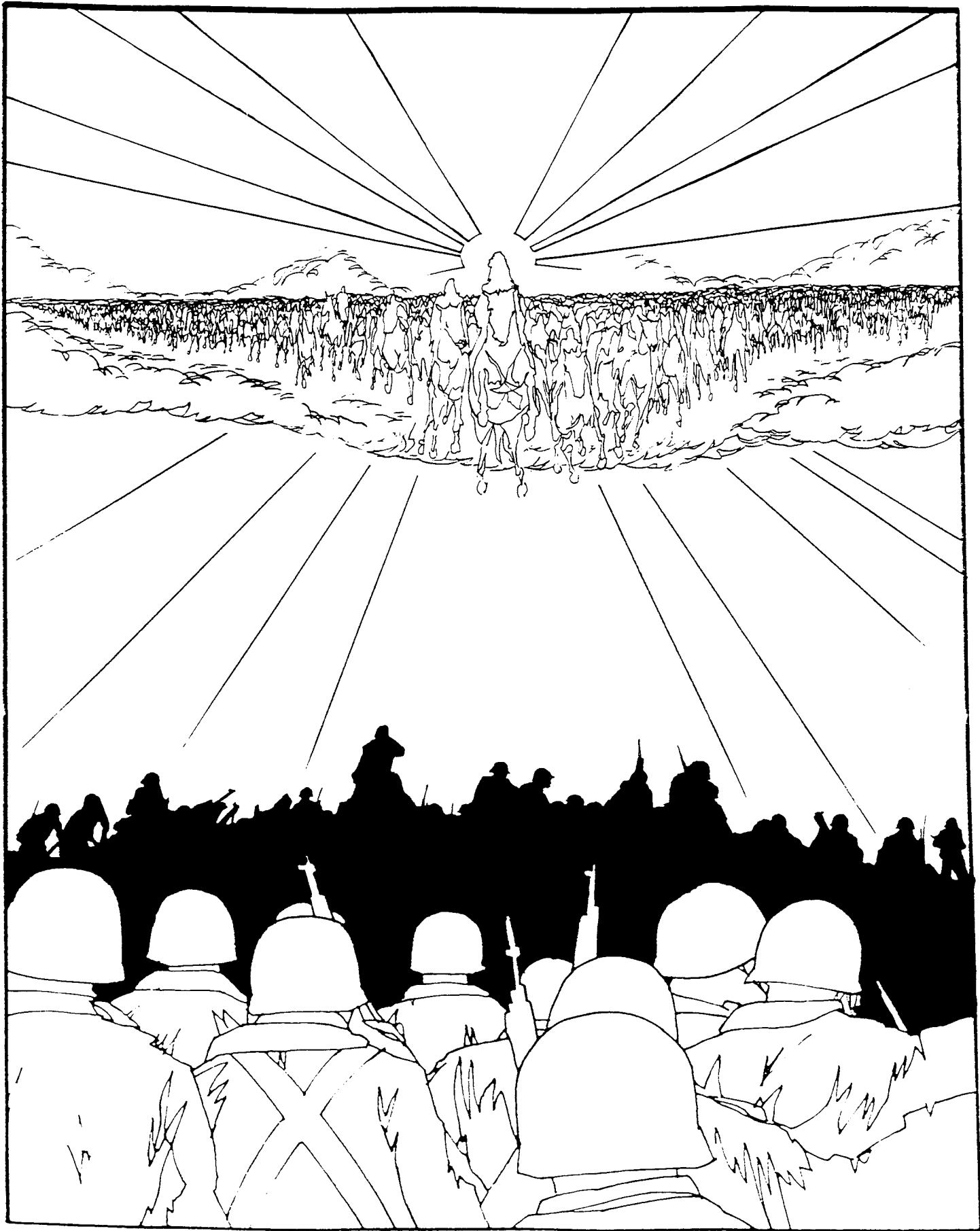

Christ defeats the armies of the beast.
REVELATION 19:11-21

318. CHRIST DEFEATS THE ARMIES OF THE BEAST (REVELATION 19:11-21)

MEMORY VERSE:

"Now I saw heaven opened, and behold, a white horse. And He who sat on him was called Faithful and True, and in righteousness He judges and makes war."

REVELATION 19:11

TRUE OR FALSE:

1. "Now I saw heaven opened, and behold, a white horse. And He who sat on him was called Faithful and True, and in righteousness He judges and makes war." **REVELATION 19:11**

TRUE OR FALSE

2. "His eyes were like a flame of fire, and on His head were many crowns. He had a name written that no one knew except Himself." **REVELATION 19:12**

TRUE OR FALSE

CIRCLE THE CORRECT WORDS:

3. "And the armies in heaven, clothed in fine line, white and clean, followed Him on white (CHARIOTS, HORSES)." **REVELATION 19:14**

4. "Now out of His mouth goes a sharp (SWORD, ARROW), that with it He should strike the nations. And He Himself will rule them with a (BOOK, ROD) of iron." **REVELATION 19:15**

TRUE OR FALSE:

5. "And He has on His robe and on His thigh a name written: 'KING OF KINGS AND LORD OF LORDS.'" **REVELATION 19:16**

TRUE OR FALSE

6. "Then the beast was captured, and with him the false prophet who worked signs in his presence, by which he deceived those who received the mark of the beast and those who worshiped his image..." **REVELATION 19:20**

TRUE OR FALSE

CIRCLE THE CORRECT WORD:

7. "...These two were cast alive into the lake of (FIRE, WATER) burning with brimstone." **REVELATION 19:20**

318. CHRIST DEFEATS THE ARMIES OF THE BEAST

(REVELATION 19:11-21)

L O R D O F L O R D S T C A T
 B S H C B E A S T A L A R H F
 B R W R Z R K M Q U P M E U I
 R E O O Q B A F F T I W F M E
 N S K W R R I H U E O M A W N
 U R I N K D T R S R O G L O E
 N O N S R I E W D U E W S K N
 O H G P A D O O T S T A E P I
 R E O F C N F H Y Z T R P S L
 I T F B M G H F Q S J I R C E
 F I K L O P E T L U D I O I N
 O H I D A K A A D P D R P B I
 D W N Z Q M V G U P V P H P F
 O F G T Q K E B L E H Z E B C
 R Q S A I S N C S R O T T D B

ARMIES
 BEAST
 BIRDS
 CAPTURED
 CROWNS
 FAITHFUL

FALSE PROPHET
 FINE LINEN
 FLAME
 HEAVEN
 IMAGE
 JUDGES

KING OF KINGS
 LORD OF LORDS
 MARK
 MOUTH
 ROD OF IRON
 SUPPER

SWORD
 THE WORD OF GOD
 TRUE
 WAR
 WHITE HORSE

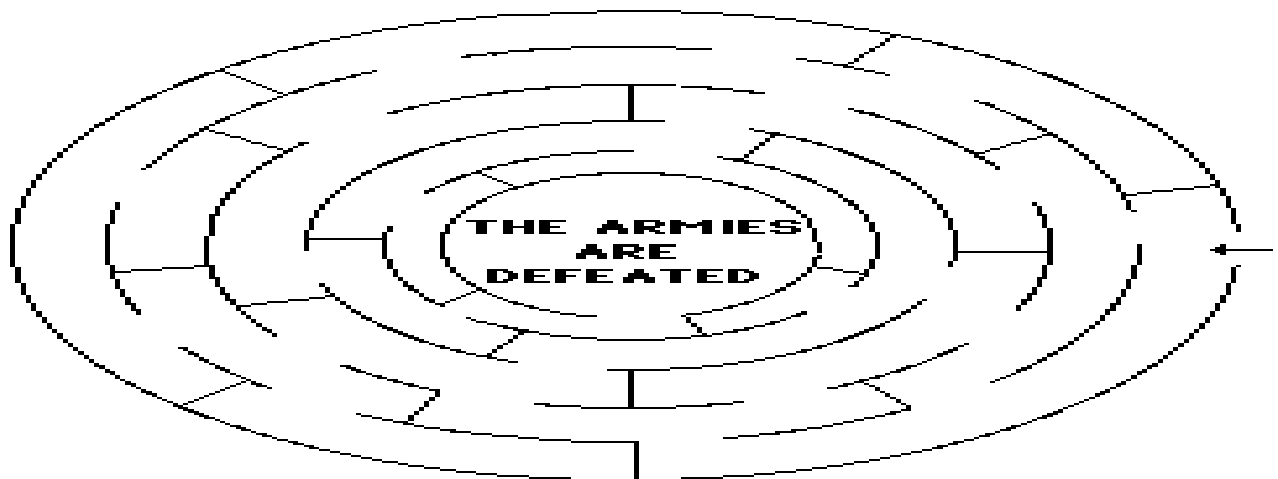

318. CHRIST DEFEATS THE ARMIES OF THE BEAST (REVELATION 19:11-21)

MEMORY VERSE:

"Now I saw heaven opened, and behold, a white horse. And He who sat on him was called Faithful and True, and in righteousness He judges and makes war."

REVELATION 19:11

TRUE OR FALSE:

1. "Now I saw heaven opened, and behold, a white horse. And He who sat on him was called Faithful and True, and in righteousness He judges and makes war." **REVELATION 19:11**

TRUE OR FALSE

2. "His eyes were like a flame of fire, and on His head were many crowns. He had a name written that no one knew except Himself." **REVELATION 19:12**

TRUE OR FALSE

FILL IN THE BLANKS:

3. "And the armies in heaven, clothed in fine line, white and clean, followed Him on white _____." **REVELATION 19:14**

4. "Now out of His mouth goes a sharp _____, that with it He should strike the nations. And He Himself will rule them with a _____ of iron." **REVELATION 19:15**

TRUE OR FALSE:

5. "And He has on His robe and on His thigh a name written: 'KING OF KINGS AND LORD OF LORDS.'" **REVELATION 19:16**

TRUE OR FALSE

6. "Then the beast was captured, and with him the false prophet who worked signs in his presence, by which he deceived those who received the mark of the beast and those who worshiped his image..." **REVELATION 19:20**

TRUE OR FALSE

FILL IN THE BLANK:

7. "...These two were cast alive into the lake of _____ burning with brimstone."

REVELATION 19:20

318. CHRIST DEFEATS THE ARMIES OF THE BEAST (REVELATION 19:11-21)

Y M C V B B I E T R W M Z F R K V D K W Q I R B F A R V T I
 R A W D P B P O H K S E B A B Y B C K V P P L J I H C S Q G
 G S S K U B M J K Z C J E Y Q F Q A O B S Z B Y E V R D B A
 H O L B U U W S W L T L Q B K D J B C W B V D T O L L R U F
 S A S S R L L Z W B P D A C L Q C F T M U Q V B Z V S F V W
 E L N H J Y G N B I M Z L M E N A L N V D Q Z H E R P N D Z
 Q K P P Z L S W D V S P B U S N S I B Z Z U R H T U O M E W
 M N M P F H Z I O D D T F A S F B H U S G N I K F O G N I K
 B M N R J B R O G V E E S K Z D W V Q Q O S B Q R E E V H R
 B G Q B F K O V F T Q R H A R Y R M D B B D E A I R F V M U
 C G Q N E K J M O L H B U I E V D I N U U E A E Y T Z B U J
 B T H G O B L G D C E L V T L B I E B O O B S D M Q L W N Z
 B E V B R D L D R M N I E L P Y E Y Y L R B T B S S V J C Q
 Y L Z L I O A O O G P A L O U A A H U W B I K I I W O B A I
 U S U L Y F G T W K T I S Z C B C F T D T U F Z L S L E J T
 W V D N S F H C E M L D C I R F H Y C F L Q T O N J Z D K F
 D P F B Y L G U H P R R J J H T F S Z Y O R E E D R J C R T
 O Z H Z D A N V T O Z O I E I P S A Y N U K S E D O P V L A
 K S G S Y M W N L E T N A A K E J Q L E R R R F G Q R H C U
 J M U V B E B F L I T V F Z I N T K S S O J G A G A N H B C
 Q B Q M O B O V R P E T T M G I L Y V H E A I A M E M A B M
 B A J O J D W M Q N B V R T W D N J E K F P V K N U E I B P
 Z K V N R Q B U C L S A B T T L J T B P F D R I W S N H U W
 P I Q O C R V O R E M B I I D G I P T H Z I L O Z O R B J Q
 Q Y L G V K B B H P H K S J C H J A G Q R E M Q P K B E Y Z
 L T D I G D H M N K V N U I W U O V H O N O V S A H I U Z K
 D R O W S F C G N S W C B J D R I T Q I F B O W K S E D D Q
 A F D C W H O Q V O Y E B G V A M P F Z M E V Y Z J R T D K
 L Z D N H L Y O R N B U E B S F U G Z F C O O U E F B J H P
 L B V E H D K C G U L S B B U W Z F T L R N F R E P P U S U

- | | | | |
|----------|---------------|-------------------|-----------------|
| ARMIES | FALSE PROPHET | KING OF KINGS | SWORD |
| BEAST | FINE LINEN | LORD OF LORDS | THE WORD OF GOD |
| BIRDS | FLAME | MARK OF THE BEAST | TRUE |
| CAPTURED | HEAVEN | MOUTH | WAR |
| CROWNS | IMAGE | ROD OF IRON | WHITE HORSE |
| FAITHFUL | JUDGES | SUPPER | |

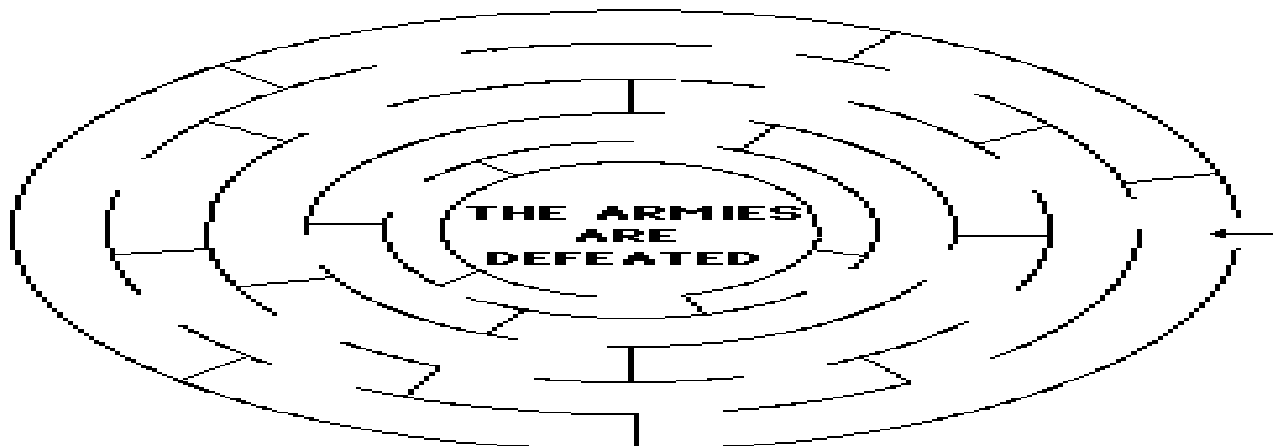

318. CHRIST DEFEATS THE ARMIES OF THE BEAST (REVELATION 19:11-21)

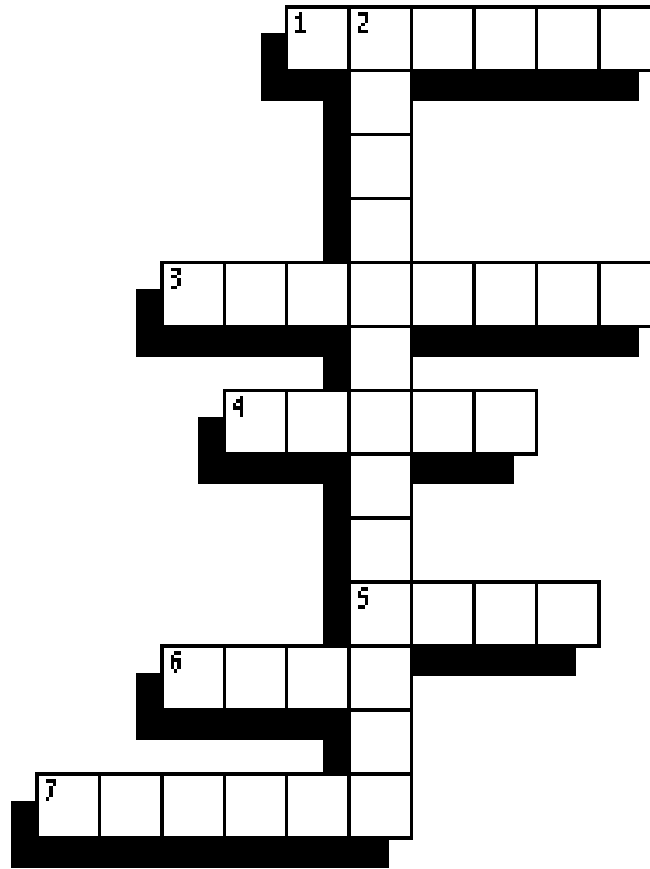

- 2 DOWN "Now I saw heaven opened, and behold, a white horse. And He who sat on him was called Faithful and True, and in ____ He judges and makes war." **REVELATION 19:11**
- 1 ACROSS "His eyes were like a flame of fire, and on His head were many _____. He had a name written that no one knew except Himself." **REVELATION 19:12**
- 7 ACROSS "And the _____ in heaven, clothed in fine linen, white and clean, followed Him on white horses." **REVELATION 19:14**
- 4 ACROSS "Now out of His mouth goes a sharp _____, that with it He should strike the nations. And He Himself will rule them with a rod of iron." **REVELATION 19:15**
- 5 ACROSS "And He has on His robe and on His thigh a _____ written: 'KING OF KINGS AND LORD OF LORDS.'" **REVELATION 19:16**
- 3 ACROSS "Then the beast was _____, and with him the false prophet who worked signs in his presence, by which he deceived those who received the mark of the beast and those who worshiped his image..." **REVELATION 19:20**
- 6 ACROSS "...These two were cast alive into the lake of _____ burning with brimstone." **REVELATION 19:20**

Bible Story 319

THE MILLENNIUM

REVELATION 20:1-6

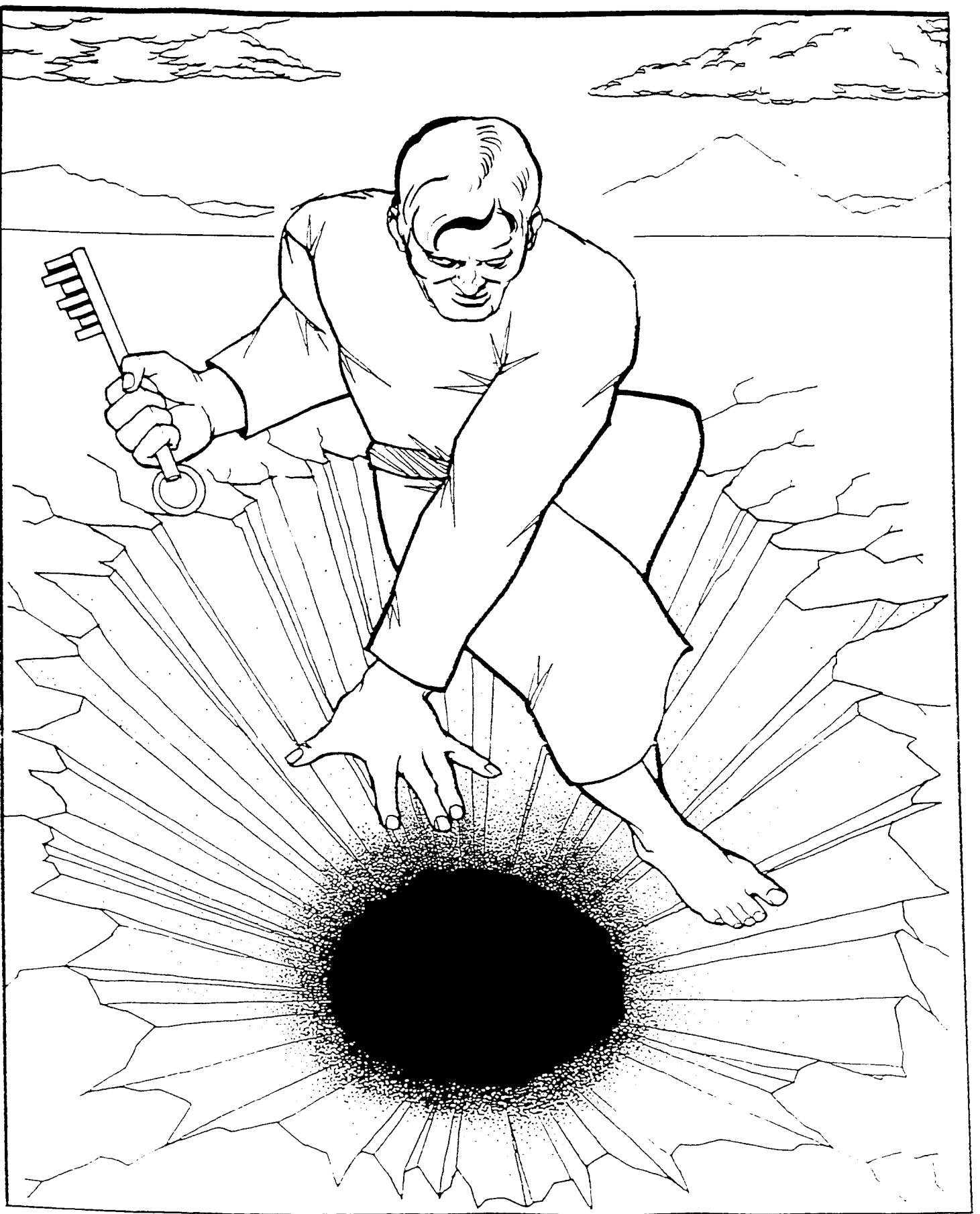

Then John "saw an angel coming down from heaven,
having the key to the bottomless pit and a great chain in his hand."

REVELATION 20:1

319. THE MILLENNIUM

(REVELATION 20:1-6)

MEMORY VERSE:

"Blessed and holy is he who has part in the first resurrection. Over such the second death has no power, but they shall be priests of God and of Christ, and shall reign with Him a thousand years." REVELATION 20:6

CIRCLE THE CORRECT WORDS:

1. "Then I saw an angel coming down from heaven, having the **(KEY, LID)** to the bottomless pit and a great chain in his hand." REVELATION 20:1
2. "He laid hold of the dragon, that serpent of old, who is the Devil and Satan, and bound him for a **(HUNDRED, THOUSAND)** years." REVELATION 20:2

TRUE OR FALSE:

3. "And he cast him into the bottomless pit, and shut him up, and set a seal on him, so that he should deceive the nations no more till the thousand years were finished..."
REVELATION 20:3
TRUE OR FALSE
4. ...But after these things he must be released for a long time. REVELATION 20:3
TRUE OR FALSE
5. Then John saw the souls of those who had died "for their witness to Jesus and for the word of God, who had not worshiped the beast or his image, and had not received his mark on their foreheads or on their hands..." REVELATION 20:4
TRUE OR FALSE

CIRCLE THE CORRECT WORD:

6. "...And they lived and **(DIED, REIGNED)** with Christ for a thousand years." REVELATION 20:4

TRUE OR FALSE:

7. "But the rest of the dead did not live again until the thousand years were finished. This is the first resurrection." REVELATION 20:5
TRUE OR FALSE

319. THE MILLENNIUM

(REVELATION 20:1-6)

B O T T O M L E S S P I T L T
J F R H P Q D H E A V E N H H
U T E A D R B R W Q D K O U O
D N I N B H I I A E N U T R L
G O G D B O T E V G S K L E Y
M I N S R N Z I S A O I A L S
E T E U E S L Z N T V N L E L
N C D S N B D D D E S A B A U
T E S V D S Y A D E E O C S O
W R G H U E W Q E S C F Q E S
D R A U A N S O M H L E Y D S
C U D R R O K S R I E E I L A
A S S M A R K E E D P R G V Z
J E S U S H T R Y L K W O N E
K R B B F T A C Q R B F Q F A

ANGEL
BLESSED
BOTTOMLESS PIT
DECEIVE
DEVIL
DRAGON
FOREHEADS

HANDS
HEAVEN
HOLY
JESUS
JUDGMENT
KEY

LIVED
MARK
PRIESTS
REIGNED
RELEASED
RESURRECTION

SEAL
SOULS
THOUSAND YEARS
THRONES
WITNESS
WORD

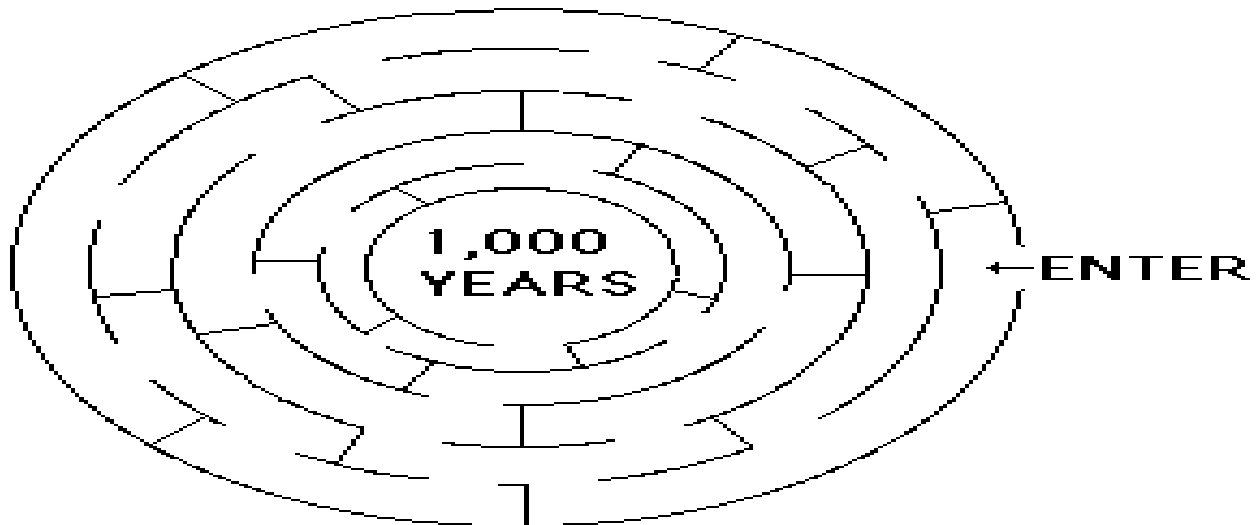

319. THE MILLENNIUM

(REVELATION 20:1-6)

MEMORY VERSE:

"Blessed and holy is he who has part in the first resurrection. Over such the second death has no power, but they shall be priests of God and of Christ, and shall reign with Him a thousand years." REVELATION 20:6

FILL IN THE BLANKS:

1. "Then I saw an angel coming down from heaven, having the _____ to the bottomless pit and a great chain in his hand." **REVELATION 20:1**
2. "He laid hold of the dragon, that serpent of old, who is the Devil and Satan, and bound him for a _____ years." **REVELATION 20:2**

TRUE OR FALSE:

3. "And he cast him into the bottomless pit, and shut him up, and set a seal on him, so that he should deceive the nations no more till the thousand years were finished..."
REVELATION 20:3
TRUE OR FALSE
4. ...But after these things he must be released for a long time. **REVELATION 20:3**
TRUE OR FALSE
5. Then John saw the souls of those who had died "for their witness to Jesus and for the word of God, who had not worshiped the beast or his image, and had not received his mark on their foreheads or on their hands..." **REVELATION 20:4**
TRUE OR FALSE

FILL IN THE BLANK:

6. "...And they lived and _____ with Christ for a thousand years." **REVELATION 20:4**

TRUE OR FALSE:

7. "But the rest of the dead did not live again until the thousand years were finished. This is the first resurrection." **REVELATION 20:5**
TRUE OR FALSE

319. THE MILLENNIUM

(REVELATION 20:1-6)

L J K C R W H L I D V U T C B Z P C T A A J N P G F A N B K
 H T O U R S K W R D S O W G A B Z Q C O B G R H B L E Z I Z
 T N B J W S K W F W P L U S U D F N M Y U A A L I B M F U O
 Y A H K M I R Z Y D D O G B O T T O M L E S S P I T B N Q V
 O S F A P A F O B E E U H Q V K V R P E E K P Q V K Z B H L
 A L R S N G E I C T T S B U A B F U M A D R L U S M U A C C
 V K V S S W N E R L W I A M E L I V E D S T S E I R P D C Y
 C P I M K E I A D S B I V E I U H K L E K B Y I M I I P N Y
 A U O J B V N K F A T B S J L Y N B C Q G S D A E H E R O F
 L T N T E A C T B O H R U Q S E E I S U C N M C K U J U U P
 O N H A C F V U I A J R E L G E R F G T M Y T C I B L K K D
 Z D I A D U C N E W Y W B S J E E W E V N N F S R W M I S D
 M R S O U L S U H P K G D J U J M L Y S Q M H R K V P B U A
 F A U U W H E A V E N T H E P R J J U E R Q D A Q K B R N W
 M Z A E K T C N T A P K U T S A R B S T U P R E Y G E Q E Z
 Q E F N I O H O L D G W Q W Z S Q E W D M L S Y C P C I S C
 S M R Q E M R G U Y K I T K F V E B C K N J M D Z H H J B P
 Q D F E P J E A W S G U P M B K V L I T E A C N A K M L T Y
 V W T B I K M R Y E K M L L B U E K B N I D H A K H B J I E
 P Q Q N I G Q D Q M P F J U K O V H A B S O U S R C I V L J
 B B H A Y G N D N U S O B S E N O R H T Z D N U V O V R E R
 Q I A Y B H N E W B O E J G M L V J C N P R R O Z V M R I L
 J T U Q B G Y L D O T P H C Y Z L K L E J M S H Y N T K A P
 I A U U P D M U I S R K T V Z B A D P M H J J T E J Q J K P
 C L T Q P V A F S E W D J U B A E U A G D L L E H L V S Q B
 T B T T Y B S L S U I J Y B I V I M I D C P P N Z D U F Y B
 C Z D H F G V Y V J S L R N I M L B E U U O B O C R G Q R D
 J A N G E L Y H U M H E A L Z Z R Y Y J U L N M S Z B V B T
 W Z D T O C K B U G J F J E F B U R A Y S T S R G B D B T P
 Y N Q T J Z W O A O D Y D H S T U T Q Z Y P L B I Y O R P G

ANGEL
 BLESSED
 BOTTOMLESS PIT
 DECEIVE
 DEVIL
 DRAGON
 FIRST RESURRECTION

FOREHEADS
 HANDS
 HEAVEN
 HOLY
 JESUS
 JUDGMENT

KEY
 LIVED
 MARK
 ONE THOUSAND YEARS
 PRIESTS
 REIGNED

RELEASED
 SEAL
 SOULS
 THRONES
 WITNESS
 WORD



319. THE MILLENNIUM

(REVELATION 20:1-6)

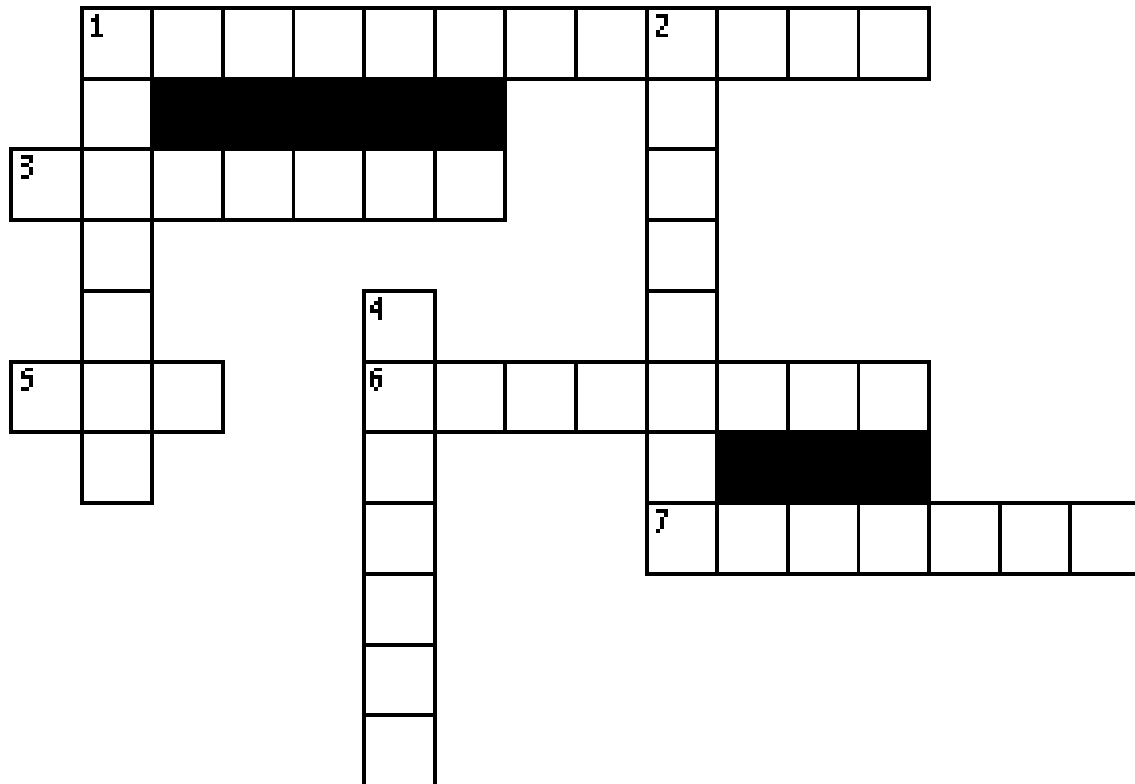

- 5 ACROSS "Then I saw an angel coming down from heaven, having the _____ to the bottomless pit and a great chain in his hand." **REVELATION 20:1**
- 2 DOWN "He laid hold of the dragon, that serpent of old, who is the Devil and Satan, and bound him for a _____ years." **REVELATION 20:2**
- 7 ACROSS "And he cast him into the bottomless pit, and shut him up, and set a seal on him, so that he should _____ the nations no more till the thousand years were finished..." **REVELATION 20:3**
- 6 ACROSS "...But after these things he must be _____ for a little while." **REVELATION 20:3**
- 3 ACROSS Then John saw the souls of those who had died "for their _____ to Jesus and for the word of God, who had not worshiped the beast or his image, and had not received his mark on their foreheads or on their hands..." **REVELATION 20:4**
- 1 DOWN "...And they lived and _____ with Christ for a thousand years." **REVELATION 20:4**
- 1 ACROSS "But the rest of the dead did not live again until the thousand years were finished. This is the first _____." **REVELATION 20:5**
- 4 DOWN "Blessed and holy is he who has part in the first resurrection. Over such the second death has no power, but they shall be _____ of God and of Christ, and shall reign with Him a thousand years." **REVELATION 20:6**

Bible Story 320

THE LAKE OF FIRE

REVELATION 20:7-10; 14-15

320. THE LAKE OF FIRE
(REVELATION 20:7-10, 14-15)



"And the devil that deceived them was cast into the lake of fire and brimstone, where the beast and the false prophet *are*, and shall be tormented day and night for ever and ever."

REVELATION 20:10

320. THE LAKE OF FIRE (REVELATION 20:7-10, 14-15)

MEMORY VERSE:

"And anyone not found written in the Book of Life was cast into the lake of fire."
REVELATION 20:15

TRUE OR FALSE:

1. "Now when the thousand years have expired, Satan will be released from his prison."
REVELATION 20:7

TRUE OR FALSE

CIRCLE THE CORRECT WORD:

2. "...and will go out to deceive the nations which are in the four corners of the earth, Gog and Magog, to gather them together to battle, whose number is as the **(WATER, SAND)** of the sea."
REVELATION 20:8

TRUE OR FALSE:

3. "They went up on the breadth of the earth and surrounded the camp of the saints and the beloved city..." REVELATION 20:9

TRUE OR FALSE

CIRCLE THE CORRECT WORDS:

4. "...And **(WATER, FIRE)** came down from God out of heaven and devoured them."
REVELATION 20:9
5. "The devil, who deceived them, was cast into the lake of **(WATER, FIRE)** and brimstone where the beast and the false prophet are..." REVELATION 20:10

TRUE OR FALSE:

6. "...And they will be tormented day and night forever and ever." REVELATION 20:10

TRUE OR FALSE

7. "Then Death and Hades were cast into the lake of fire. This is the second death."
REVELATION 20:14

TRUE OR FALSE

320. THE LAKE OF FIRE

(REVELATION 20:7-10, 14-15)

L A K E O F F I R E B M C T S
C P S A T A N F S Q Q A F E I
A A R Q T B O U L U B G C I O
S E F I L F O K O O B O F N M
T O B G S S W S Z W N G A W D
B W E O N O A A A D A F L D E
E E L G B K N I D N I Y S T S
V T O B P L N E N R D R E I A
I E V M Y W A H E T F L P Z E
E P E B P T T O I B S P R C L
C C D E H F I H T A E D O G E
E V C A Z I O D C T S F P F R
D T I S I W N B D T Z S H M C
N S T T C K S K C L I T E T O
V B Y I H A D E S E L B T O W

BATTLE
BEAST
BELOVED CITY
BOOK OF LIFE
CAST

DEATH
DECEIVE
FALSE PROPHET
FIRE
GOG

HADES
LAKE OF FIRE
MAGOG
NATIONS
PRISON

RELEASED
SAINTS
SAND
SATAN
SECOND DEATH

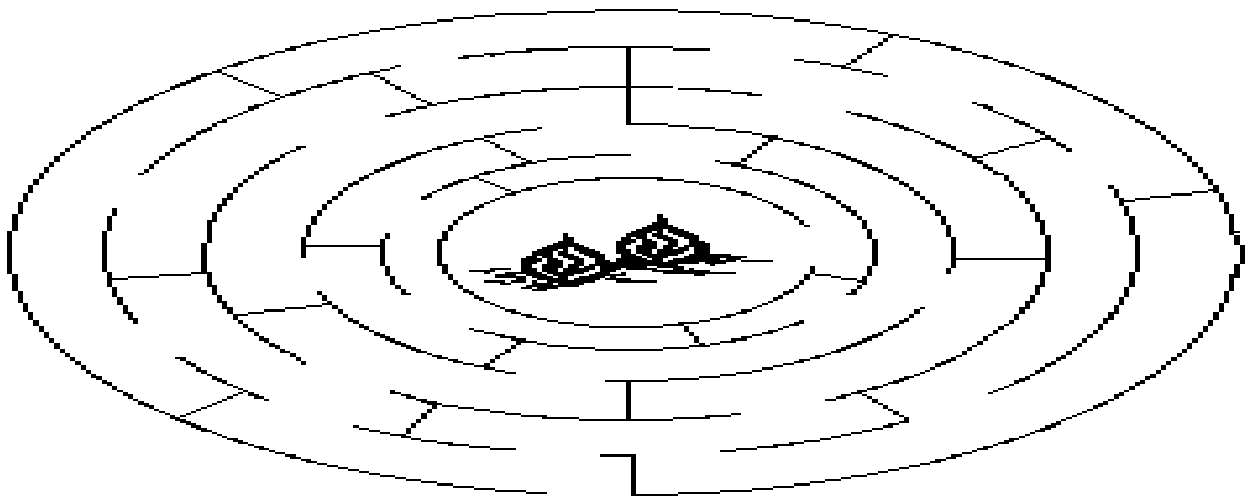

320. THE LAKE OF FIRE (REVELATION 20:7-10, 14-15)

MEMORY VERSE:

"And anyone not found written in the Book of Life was cast into the lake of fire."
REVELATION 20:15

TRUE OR FALSE:

1. "Now when the thousand years have expired, Satan will be released from his prison."
REVELATION 20:7

TRUE OR FALSE

FILL IN THE BLANK:

2. "...and will go out to deceive the nations which are in the four corners of the earth, Gog and Magog, to gather them together to battle, whose number is as the _____ of the sea."
REVELATION 20:8

TRUE OR FALSE:

3. "They went up on the breadth of the earth and surrounded the camp of the saints and the beloved city..." REVELATION 20:9

TRUE OR FALSE

FILL IN THE BLANKS:

4. "...And _____ came down from God out of heaven and devoured them."
REVELATION 20:9
5. "The devil, who deceived them, was cast into the lake of _____ and brimstone where the beast and the false prophet are..." REVELATION 20:10

TRUE OR FALSE:

6. "...And they will be tormented day and night forever and ever." REVELATION 20:10

TRUE OR FALSE

7. "Then Death and Hades were cast into the lake of fire. This is the second death."
REVELATION 20:14

TRUE OR FALSE

320. THE LAKE OF FIRE

(REVELATION 20:7-10, 14-15)

E Y P Y D D O F Q W U G O Y G G V Y H B Z I U J R
 B Z C M O K E R B D M S A T A N E T J K S V U E O
 Z E V B O A Z C V I A I V E O O N T L G B G L D R
 I U A P K G P G B C G E Y H Q J J G B P E E Y E C
 I G U S P S E O W P O G E L A M A F B E A U D Q C
 D F I R T A U W Y L G W B F E N B I K S W E O W U
 Z Y S N O I T A N O D K C B I E H Y E I A K L D B
 P I P Y Z U V T U P I O J R L L P D N T G J P U R
 Z F N R E K F J E D V I N O G R F M H N B W Z A B
 V B S E R S I V K H E L V O I R N O P A T S P B P
 U L C B I Y U H Y Q P E B S A M Y R K G O G Z C I
 D A N V F B H Y H J D O O W T I W A F O D F B Q Y
 W E P T F F I G F C M N R H N F C U H V O Z F K V
 C Z C O O I P M I J N D L P B J N V J I S B P H N
 E A B J E R K T Q C B S L J E Q R W K W T Z T C W
 E C S Q K E Y B B B A U D S K S G A Z A N E S H E
 B L C T A F E U H V S J N R L E L T W M I S A L H
 D W B L L L R V M D P L K V D P I A W H A G W U Z
 V C P P T L E E E V I E C E D G K Z F L S Y I A J
 N A R T S K N Z G I W J A J O G F V V A P M L B H
 P Z A V T I A H T A E D D N O C E S H Z T B V G A
 Y B E G V Q I U Q M J T U D H L T K W Y C O U D D
 G S M Y G S P U W O H B W U Y Y S B S E P L A V E
 N D H D N A S I G O N V K V Q T T M R K N F G Z S
 W G Y Q W S Q X X F F Q Y C K P O S V G B W O Y Q

- | | | | |
|---------------------|----------------------|---------------------|---------------------|
| BATTLE | DEATH | HADES | RELEASED |
| BEAST | DECEIVE | LAKE OF FIRE | SAINTS |
| BELOVED CITY | FALSE PROPHET | MAGOG | SAND |
| BOOK OF LIFE | FIRE | NATIONS | SATAN |
| CAST | GOG | PRISON | SECOND DEATH |

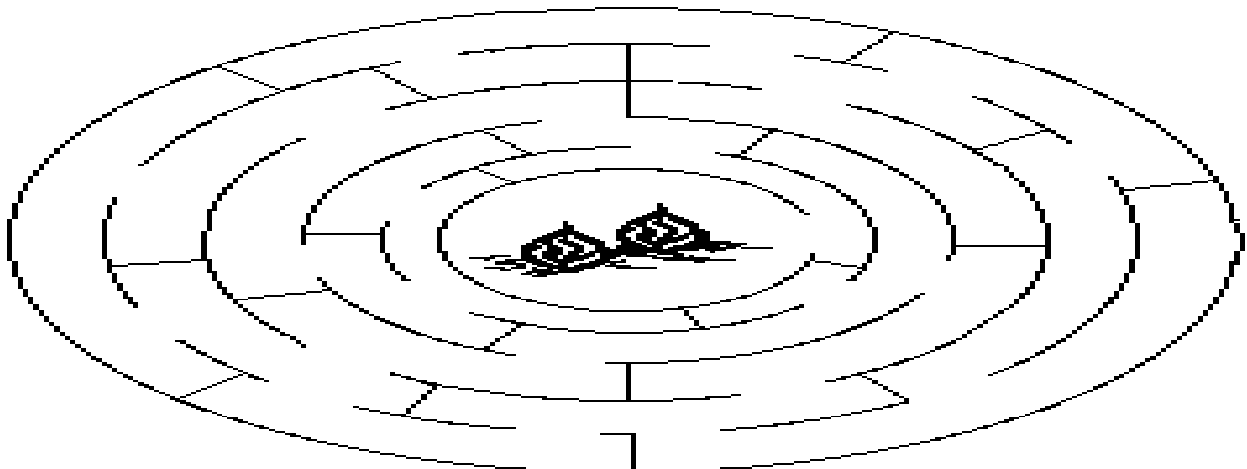

320. THE LAKE OF FIRE

(REVELATION 20:7-10, 14-15)

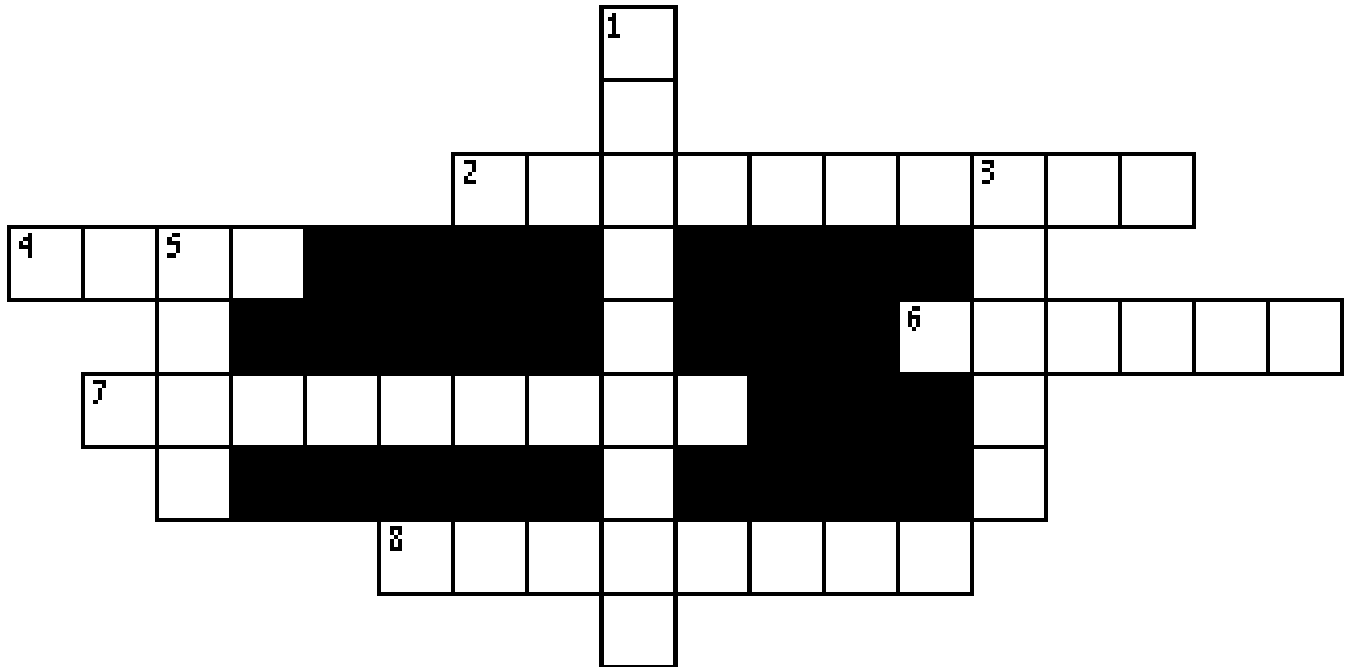

- 8 ACROSS "Now when the thousand years have expired, Satan will be _____ from his prison."
REVELATION 20:7
- 6 ACROSS "...and will go out to deceive the nations which are in the four corners of the earth, Gog and Magog, to gather them together to _____, whose number is as the sand of the sea." **REVELATION 20:8**
- 2 ACROSS "They went up on the breadth of the earth and _____ the camp of the saints and the beloved city..."
REVELATION 20:9
- 5 DOWN "...And _____ came down from God out of heaven and devoured them." **REVELATION 20:9**
- 7 ACROSS "The devil, who deceived them, was cast into the lake of fire and _____ where the beast and the false prophet are..." **REVELATION 20:10**
- 1 DOWN "...And they will be _____ day and night forever and ever." **REVELATION 20:10**
- 3 DOWN "Then Death and Hades were cast into the lake of fire. This is the second _____." **REVELATION 20:14**
- 4 ACROSS "And anyone not found written in the Book of _____ was cast into the lake of fire."
REVELATION 20:15

Bible Story 321

**THE
GREAT
WHITE THRONE
JUDGMENT**

REVELATION 20:11-15

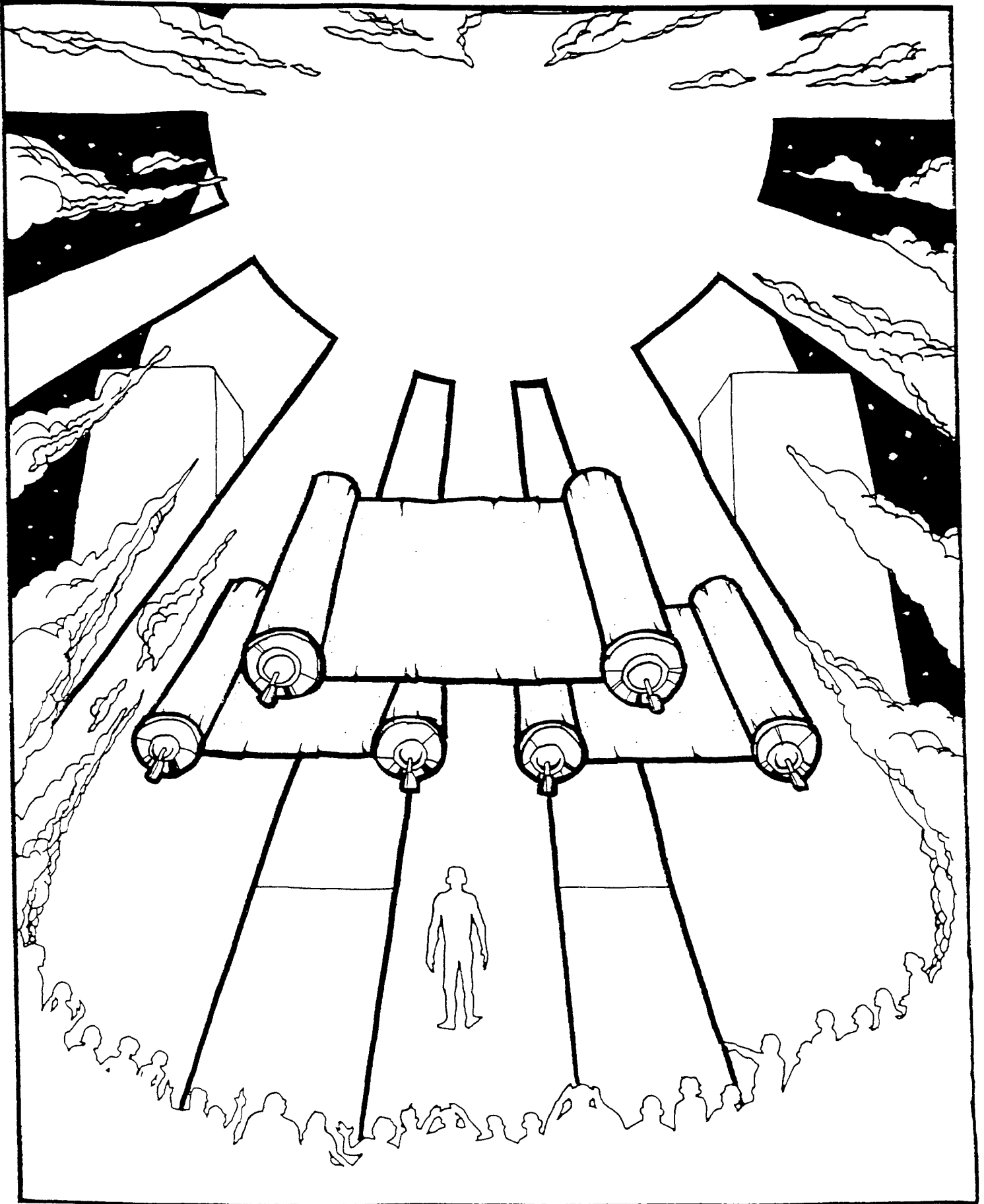

The Great White Throne Judgment
REVELATION 20:11-15

321. THE GREAT WHITE THRONE JUDGMENT

(REVELATION 20:11-15)

MEMORY VERSE:

"And I saw the dead, small and great, standing before God, and books were opened. And another book was opened, which is the Book of Life." REVELATION 20:12

John writes...

TRUE OR FALSE:

1. "Then I saw a great white throne and Him who sat on it, from whose face the earth and the heaven fled away. And there was found no place for them." **REVELATION 20:11**
TRUE OR FALSE
2. "And I saw the dead, small and great, standing before God, and books were opened..." **REVELATION 20:12**
TRUE OR FALSE
3. "...And another book was opened, which is the Book of Life..." **REVELATION 20:12**
TRUE OR FALSE

CIRCLE THE CORRECT WORDS:

4. "...And the (**DEAD, ALIVE**) were judged, according to their works, by the things that were written in the books." **REVELATION 20:12**
5. "The (**SKY, SEA**) gave up the dead who were in it, and Death and Hades delivered up the dead who were in them..." **REVELATION 20:13**
6. "...And they were judged, each one according to his (**WORKS, LOOKS**)."
REVELATION 20:13
7. "Then Death and Hades were cast into the lake of fire. This is the (**FIRST, SECOND**) death." **REVELATION 20:14**

TRUE OR FALSE:

8. "And anyone not found in the Book of Life was cast into the lake of fire." **REVELATION 20:15**
TRUE OR FALSE

321. THE GREAT WHITE THRONE JUDGMENT

(REVELATION 20:11-15)

W J D B A P U G F M K T M U S Q D V K C
 Z T J S W E F N P L P P F H E C A F A Z
 K E Q V L F I G G B Z L S P C K Q R T L
 K J R M Z I B Z K B Y S W E H L E F W U
 Q Z I A B L G J B A Y J E V U W N E L T
 J Z E R I F F O E K A L U A E K R J A M
 B K L Z P O Y P U C O C D A B O O K S O
 B C S S J K P N K W J V S R C I Y O P E
 R T T H H O Y U C J F T J N E V A E H M
 O I F M G O B O U U A W H L N J Y U P X
 P O A B E B D F M K H H Q W Q S D G A N
 E E N O R H T E T I H W T A E R G H B O
 N T D O G D E L F O A P O J L U T F V B
 E A Y S U Z R L D I H J E U K R J K Q U
 D N Y V W W C L L T D H W O A E I D D L
 B R W O D B G M S E Z Q D E G D U J V P
 S E C O N D D E A T H O E E D A P B S M
 K P O J R M R T V E Y A B P D S E D A H
 E I F J W K H S R J N W K T O C A S T C
 F Q V E Y W S Z C K J V S C K V T K M C

BOOKS
 BOOK OF LIFE
 CAST
 DEATH
 EARTH
 FACE

FLED
 GOD
 GREAT WHITE THRONE
 HADES
 HEAVEN
 JUDGED

LAKE OF FIRE
 OPENED
 SEA
 SECOND DEATH
 WORKS

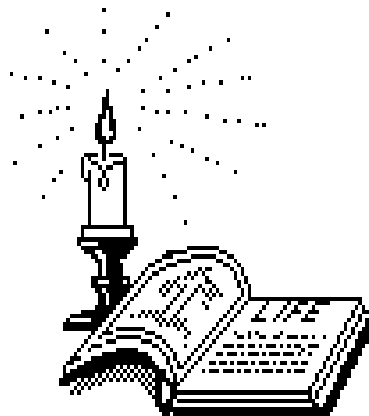

321. THE GREAT WHITE THRONE JUDGMENT

(REVELATION 20:11-15)

MEMORY VERSE:

"And I saw the dead, small and great, standing before God, and books were opened. And another book was opened, which is the Book of Life." REVELATION 20:12

John writes...

TRUE OR FALSE:

1. "Then I saw a great white throne and Him who sat on it, from whose face the earth and the heaven fled away. And there was found no place for them." **REVELATION 20:11**
TRUE OR FALSE
2. "And I saw the dead, small and great, standing before God, and books were opened..." **REVELATION 20:12**
TRUE OR FALSE
3. "...And another book was opened, which is the Book of Life..." **REVELATION 20:12**
TRUE OR FALSE

FILL IN THE BLANKS:

4. "...And the dead were _____, according to their works, by the things that were written in the books." **REVELATION 20:12**
5. "The _____ gave up the dead who were in it, and Death and Hades delivered up the dead who were in them..." **REVELATION 20:13**
6. "...And they were judged, each one according to his _____." **REVELATION 20:13**
7. "Then Death and Hades were cast into the lake of fire. This is the _____ death." **REVELATION 20:14**

TRUE OR FALSE:

8. "And anyone not found in the Book of Life was cast into the lake of fire." **REVELATION 20:15**
TRUE OR FALSE

321. THE GREAT WHITE THRONE JUDGMENT (REVELATION 20:11-15)

Y Q Y O J P D W P J K P C Q W F F Q L N G W V W B
 D H T S N R V C R Q A E G B D U G O B B G C W O Z
 G F E K D F N A E L G U O V I G I V R K L N O W Y
 C O Z L Y M P Z M P S V W B C O E Y O L Y K A V E
 B I Q D I W Y S H V A F N W P D G B W D S R T H K
 E H V F O E G D Y G U I J E L D S C H O O G Z W G
 K H L R B T N G Y F A C E Y V E W J J H P I V S Z
 Y Q K A L L W E M Y K U V U C A C N S Y E K K R S
 B S S B E M Y P N Q S H H O O A E B R Q N F B V B
 Z U R R F E Z C D O Y I N K S I K H V K E T M B E
 U F S X I Z U V E D R D Y T P J U D G E D S S K W
 F U B E L I G U L O D H G Y D V O L J G T T H G G
 J M B W F I F I F E X P T H Q E I L D O P O J P B
 U N Z G O D Y P A O F K M E J M L D U J A Y L E T
 B V F F K Z I T B K L R B F T N D N V M E T B I D
 K S W Z O P H N P P K E U Q J I S K C N S T B N P
 B L B A O Z H S R H I N V B C B H A G R V G K A T
 D B Y N B T F C Y Z T A E H B A U W O M E F N V C
 C M L S A V B N R S Q R Z M V S J U T I N I P I P
 S I N E O U L P E T S I A G D P L W Q A J Y F W N
 Z E D H U D A E R I F F O E K A L K A F E M H A B
 R O D U P W E C B V S P U Q I W J Y E J A R J M I
 D X D A W E Z B V G O Q U W M J T Y G Q H R G H V
 Y K C S H E C C T W E F I G O H B E A E N A K L G
 Q E V Y C B L B O D Z R B B O N V H T P Y U Z A U

BOOK OF LIFE
 BOOKS
 CAST
 DEATH
 EARTH
 FACE

FLED
 GOD
 GREAT WHITE THRONE
 HADES
 HEAVEN
 JUDGED

LAKE OF FIRE
 OPENED
 SEA
 SECOND DEATH
 WORKS

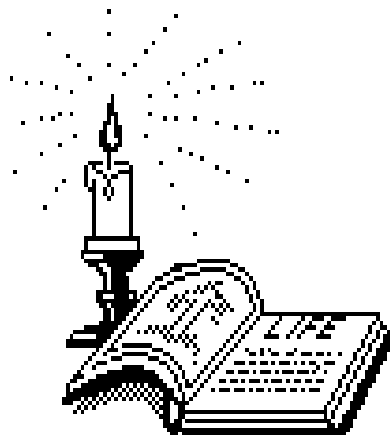

321. THE GREAT WHITE THRONE JUDGMENT

(REVELATION 20:11-15)

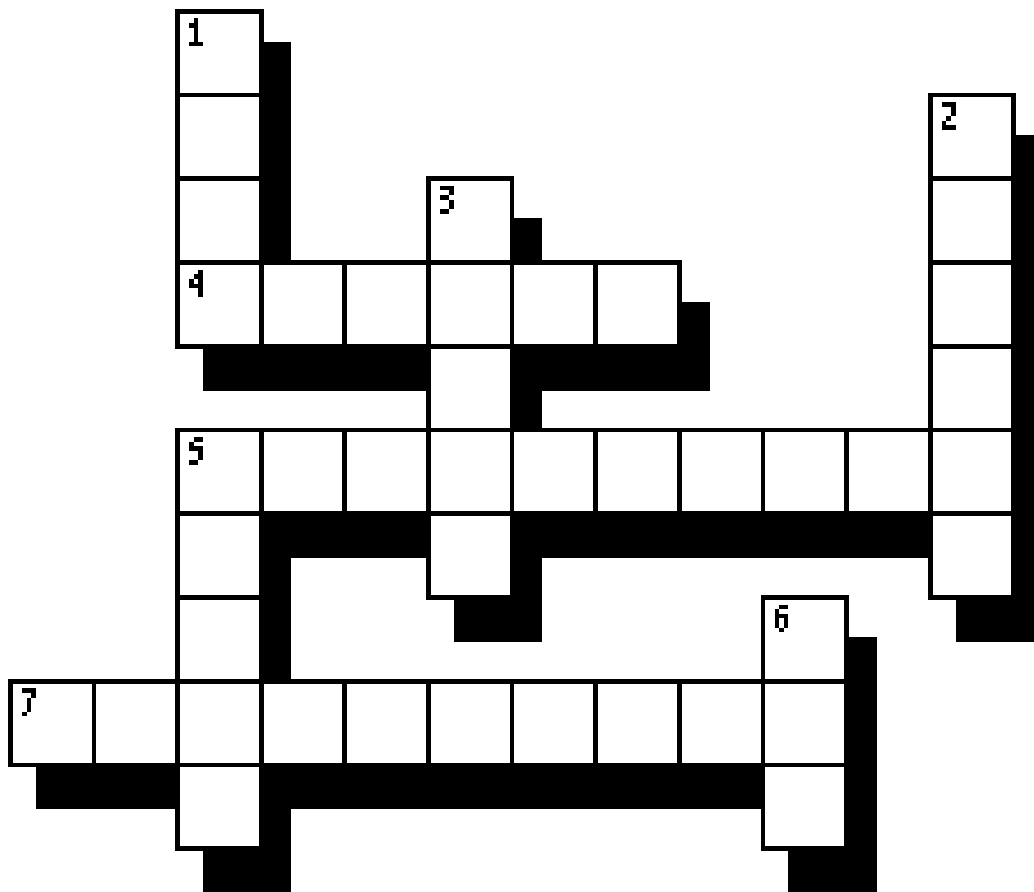

- 4 ACROSS "Then I saw a great white _____ and Him who sat on it, from whose face the earth and the heaven fled away. And there was found no place for them." **REVELATION 20:11**
- 5 DOWN "And I saw the dead, small and great, standing before God, and _____ were opened..." **REVELATION 20:12**
- 5 ACROSS "...And another book was opened, which is the _____ _____ _____..." **REVELATION 20:12**
- 2 DOWN "...And the dead were _____, according to their works, by the things that were written in the books." **REVELATION 20:12**
- 6 DOWN "The _____ gave up the dead who were in it, and Death and Hades delivered up the dead who were in them..." **REVELATION 20:13**
- 3 DOWN "...And they were judged, each one according to his _____." **REVELATION 20:13**
- 7 ACROSS "Then Death and Hades were cast into the _____ _____ _____. This is the second death." **REVELATION 20:14**
- 1 DOWN "And anyone not found in the Book of Life was _____ into the lake of fire." **REVELATION 20:15**

Bible Story 322

**A NEW HEAVEN
AND
A NEW EARTH**

REVELATION 21:1-7

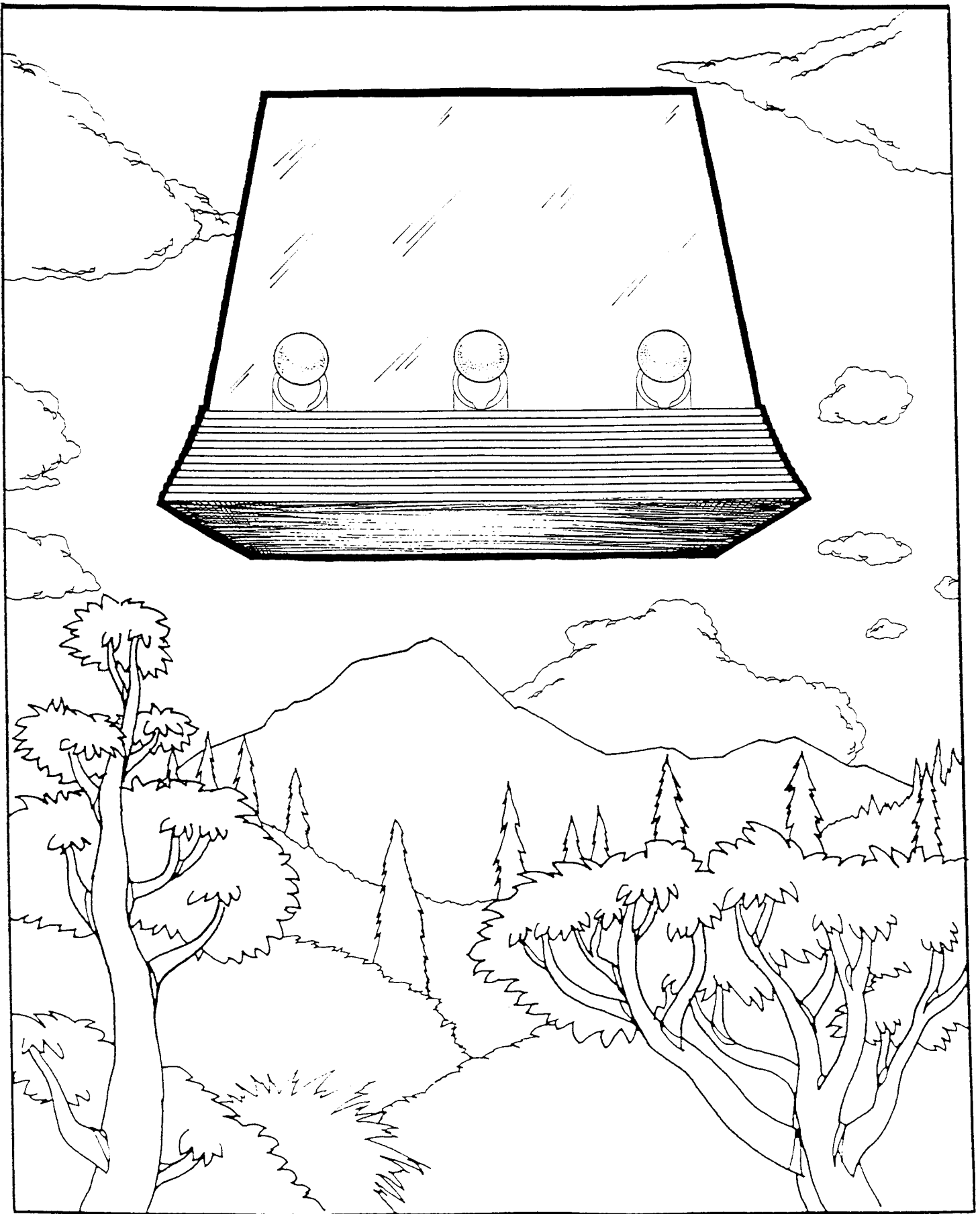

John "saw a new heaven and a new earth..."
REVELATION 21:1

322. A NEW HEAVEN AND A NEW EARTH

(REVELATION 21:1-7)

MEMORY VERSE:

"And He said to me, 'It is done! I am the Alpha and the Omega, the Beginning and the End. I will give of the fountain of the water of life freely to him who thirsts.' "
REVELATION 21:6

CIRCLE THE CORRECT WORDS:

1. "Now I saw a (**NEW, OLD**) heaven and a (**NEW, OLD**) earth, for the first heaven and the first earth had passed away. Also there was no more sea." **REVELATION 21:1**
2. "Then I, John, saw the holy city, (**NEW, OLD**) Jerusalem, coming down out of heaven from God, prepared as a bride adorned for her husband." **REVELATION 21:2**

TRUE OR FALSE:

3. "And I heard a loud voice from heaven saying, 'Behold, The tabernacle of God is with men, and He will dwell with them, and they shall be His people, and God Himself will be with them and be their God.' " **REVELATION 21:3**

TRUE OR FALSE

CIRCLE THE CORRECT WORDS:

4. "And God will wipe away every tear from their eyes; there shall be no more...**REVELATION 21:4**

TEARS

DEATH

HAPPINESS

SORROW

CRYING

PAIN

... for the former things have passed away."

TRUE OR FALSE:

5. "Then He who sat on the throne said, 'Behold, I make all things new.' And He said to John, 'Write, for these words are true and faithful.' " **REVELATION 21:5**

TRUE OR FALSE

6. "He who overcomes shall inherit all things, and I will be his God and he shall be My son." **REVELATION 21:7**

TRUE OR FALSE

322. A NEW HEAVEN AND A NEW EARTH (REVELATION 21:1-7)

C N N F P A S S E D A W A Y B
 N A E O I N E W E A R T H E B
 L E L W S R I N N A H C G R R
 N N W P J N S E O U H I I W N
 T O E H H E W T S D N D F Z I
 F P C E E A R B E N E Q M W A
 A A R R H A A U I A A A O W T
 J I I O Y N V N S F R R T O N
 T N Z T D I G E D A R T L H U
 T E A R H A N S N O L Q H F O
 T R U E N F R G S D M E A B F
 S G B D C B U O E O U E M E Z
 D W E L L W N L D G V D G B S
 B N T A B E R N A C L E I A J
 D F I R S T H E A V E N R F P

ALPHA AND OMEGA	FOUNTAIN	NEW HEAVEN	PASSED AWAY
BEGINNING AND END	GOD	NEW JERUSALEM	SEA
BRIDE	HUSBAND	NO CRYING	SON
DWELL	INHERIT	NO DEATH	TABERNACLE
FAITHFUL	NEW EARTH	NO PAIN	TEAR
FIRST EARTH	NEW	NO SORROW	TRUE
FIRST HEAVEN			

A NEW HEAVEN

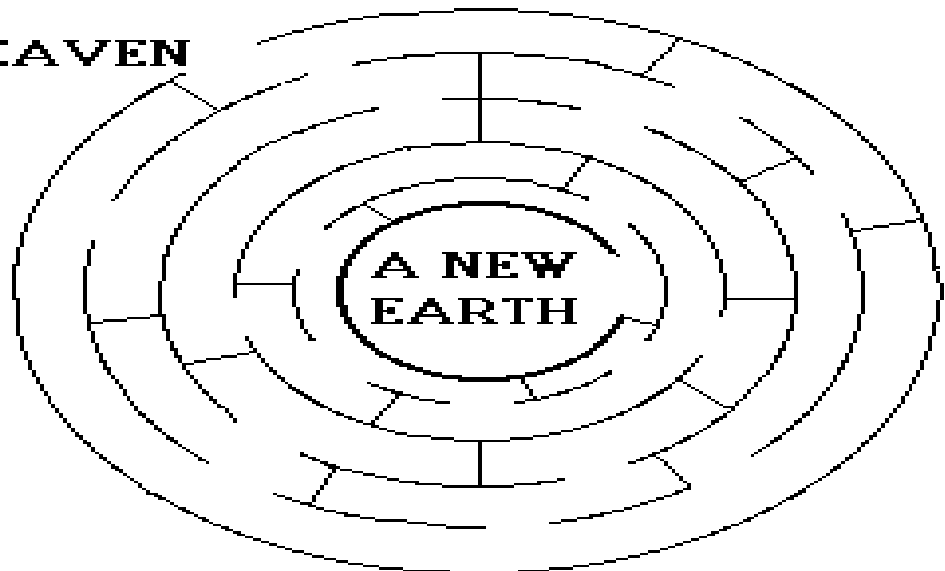

322. A NEW HEAVEN AND A NEW EARTH

(REVELATION 21:1-7)

MEMORY VERSE:

"And He said to me, 'It is done! I am the Alpha and the Omega, the Beginning and the End. I will give of the fountain of the water of life freely to him who thirsts.' "
REVELATION 21:6

FILL IN THE BLANKS:

1. "Now I saw a _____ heaven and a _____ earth, for the first heaven and the first earth had passed away. Also there was no more sea." **REVELATION 21:1**
2. "Then I, John, saw the holy city, _____ Jerusalem, coming down out of heaven from God, prepared as a bride adorned for her husband." **REVELATION 21:2**

TRUE OR FALSE:

3. "And I heard a loud voice from heaven saying, 'Behold, The tabernacle of God is with men, and He will dwell with them, and they shall be His people, and God Himself will be with them and be their God.' " **REVELATION 21:3**

TRUE OR FALSE

CIRCLE THE CORRECT WORDS:

4. "And God will wipe away every tear from their eyes; there shall be no more...
REVELATION 21:4

TEARS

DEATH

HAPPINESS

SORROW

CRYING

PAIN

... for the former things have passed away."

FILL IN THE BLANKS:

5. "Then He who sat on the throne said, 'Behold, I make all things new.' And He said to John, 'Write, for these words are _____ and _____.'" **REVELATION 21:5**

TRUE OR FALSE:

6. "He who overcomes shall inherit all things, and I will be his God and he shall be My son."
REVELATION 21:7

TRUE OR FALSE

322. A NEW HEAVEN AND A NEW EARTH (REVELATION 21:1-7)

Y B K J T H V W Z P A R S H R S H V K D F B B Y E B M I R V
 I C Q B M J K D L U O I B B T Y K Y C H I N M A V K O I C K
 U N D Y P M Y N K T Q M G M U U B S H P Z H I Y J Y D C K M
 I B N J L N E V A E H T S R I F I L Y A W A D E S S A P U V
 G E R D H T R A E T S R I F Q V C Q K Z F F Q Q B S H U E N
 N W R V Z N V E L M G Z E P P Q R B D A S S Y W L G U K A B
 I G P D D O M T L W J A Q G H T W N L G T P M Y L N S K G F
 Y V M S N D F W N Z Y G A J H B E E C C G N P F S L B S T N
 R I C U O E J I V F S O O G F D Z W N C F K S S N B A R M E
 C J A W H A A L L M T H S P N G Z H G Z G F B Y B B N H V W
 O J K T L T A M C K C N J A F A B E S R J O T B B A D Z Z J
 N B C B N H H N F F T N G B L M N A O N O P A I N L D W A E
 B G P U H P B L S U A N U P E V W V H K Q N G F E I I Q V R
 C B O Z A C G I Y E I J H N Q O R E V V N T B Y D U E I G U
 F F R Y E A B Z A N U A I Z P I D N J B N U I Q I W U B D S
 T V H B N I W K N E A G Q R L T S M G G S Y D F R M T L W A
 U S K W T U A I G N I L B B K Q E O S O R A E T B J V C Z L
 U S K D F J G K D L Y D O J N Q D B P A G G T N S D H M S E
 B J J W U E B O S Z W K Q U D K A F Q M L S N V T B H D W M
 T D H G B E M O V B A Z W M E H W U A A P R M G P R S A H W
 I C F R L E N Y E L C A N R E B A T J B T Z A E Y J A Q C M
 L N Y E G C X Y U I Q Z E Y G R N V B R H T R A E W E N R B
 J E H A U W B N R L U F H T I A F C F I H C H D Y E Q Z Y Y
 Q B L E M R C F O P Q N Y Q S B C B Y H E V D O Q Z Y Y E C
 Q U P V R K T H A S H Q V F M B F P L C O P Y G I G J D V O
 L R Z M B I P K E V O P L B E W V S O J B F D J U C G P D B
 W G G K E Y T B S U O R K O Y E V I J B N B N C F P L W A V
 P G E Y B E I A N H U M R N Q B I R I C A N D I R W E Q F N
 L S B L U J U E F B C O S O Q L N E W Y W I O R G L P H B P
 P S R A M C E W Q D L Q F I W P V W G C Z S O C L R J B E R

ALPHA AND OMEGA
 BEGINNING AND END
 BRIDE
 DWELL
 FAITHFUL
 FIRST EARTH
 FIRST HEAVEN

FOUNTAIN
 GOD
 HUSBAND
 INHERIT
 NEW EARTH
 NEW

NEW HEAVEN
 NEW JERUSALEM
 NO CRYING
 NO DEATH
 NO PAIN
 NO SORROW

PASSED AWAY
 SEA
 SON
 TABERNACLE
 TEAR
 TRUE

A NEW HEAVEN



322. A NEW HEAVEN AND A NEW EARTH (REVELATION 21:1-7)

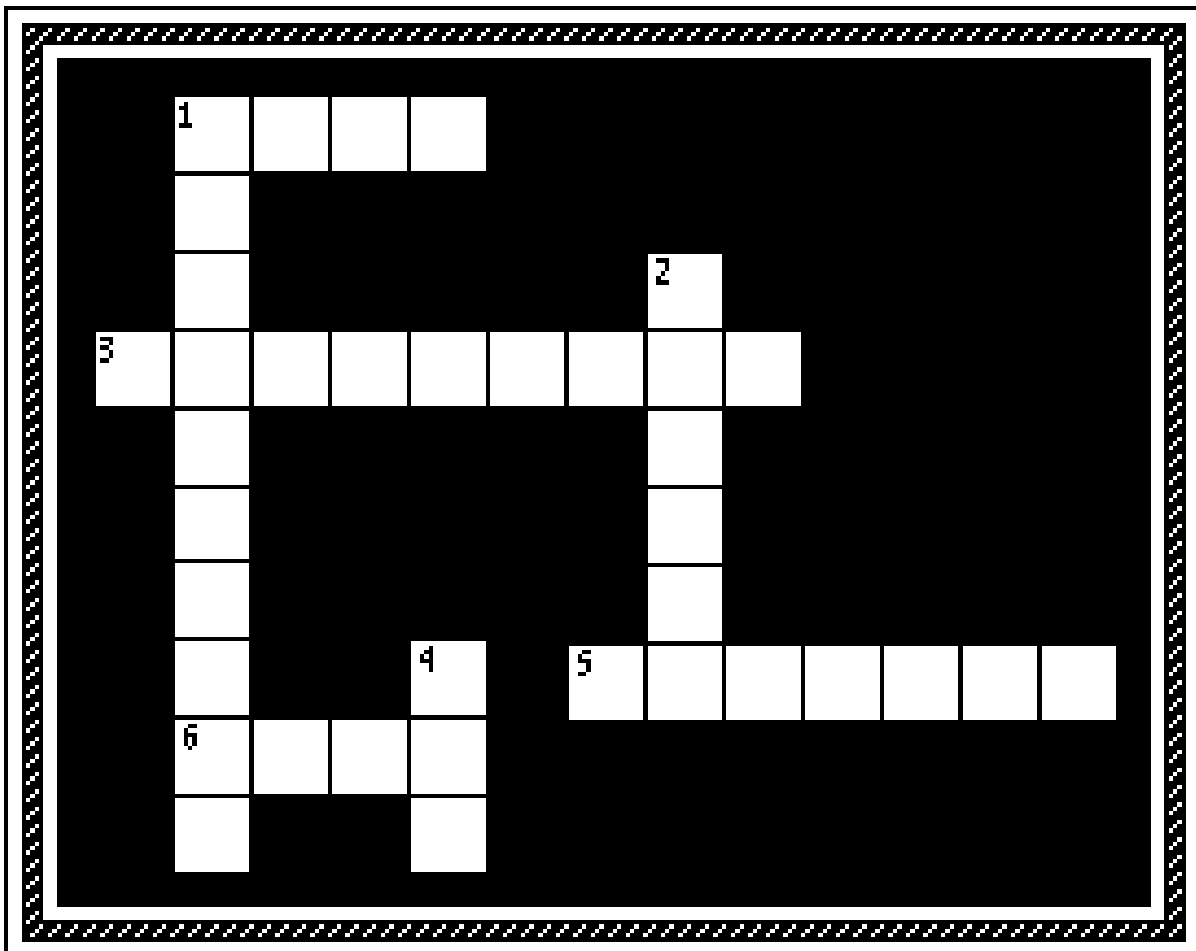

- 2 DOWN "Now I saw a new _____ and a new earth, for the first heaven and the first earth had passed away. Also there was no more sea." **REVELATION 21:1**
- 3 ACROSS "Then I, John, saw the holy city, new _____, coming down out of heaven from God, prepared as a bride adorned for her husband." **REVELATION 21:2**
- 1 DOWN "And I heard a loud voice from heaven saying, 'Behold, The _____ of God is with men, and He will dwell with them, and they shall be His people, and God Himself will be with them and be their God.' "**REVELATION 21:3**
- 1 ACROSS "And God will wipe away every _____ from their eyes..." **REVELATION 21:4**
- 4 DOWN "Then He who sat on the throne said, 'Behold, I make all things _____.' And He said to John, 'Write, for these words are true and faithful.'" **REVELATION 21:5**
- 6 ACROSS "And He said to me, 'It is done! I am the Alpha and the Omega, the Beginning and the End. I will give of the fountain of the water of _____ freely to him who thirsts.'" **REVELATION 21:6**
- 5 ACROSS "He who overcomes shall _____ all things, and I will be his God and he shall be My son." **REVELATION 21:7**

Bible Story 323

THE NEW JERUSALEM

REVELATION 21:9-27

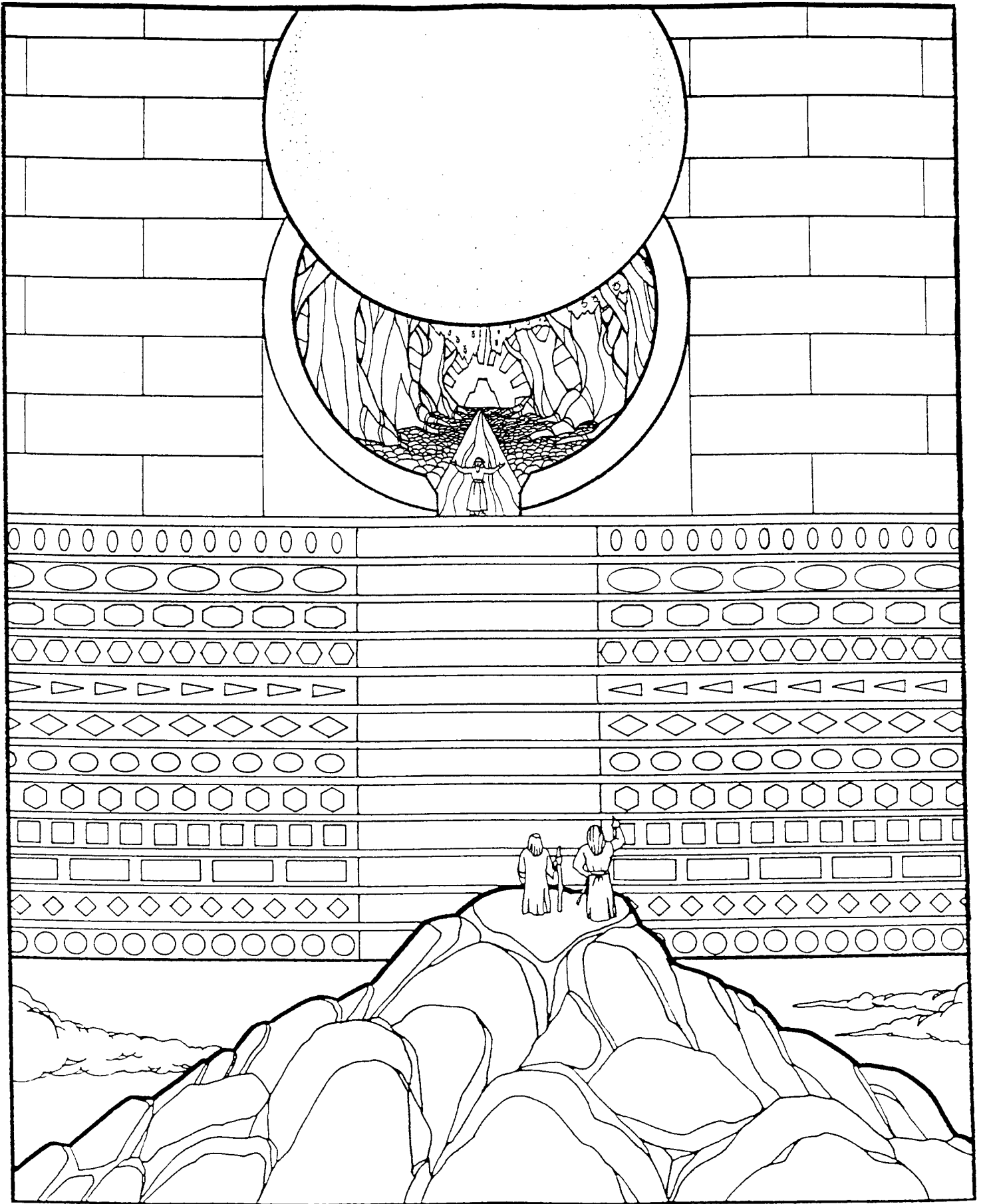

John is shown the New Jerusalem.
REVELATION 21:9-27

323. THE NEW JERUSALEM

(REVELATION 21:9-27)

MEMORY VERSE:

"Then I, John, saw the holy city, New Jerusalem, coming down out of heaven from God, prepared as a bride adorned for her husband." REVELATION 21:2

CIRCLE THE CORRECT WORDS:

1. "Then one of the seven angels who had the seven bowls filled with the seven last plagues came to me and talked with me, saying, 'Come, I will show you the bride, the (LAMB'S, PHARAOH'S) wife.' "
REVELATION 21:9
2. "And he carried me away in the Spirit to a great and high mountain, and showed me the great city, the holy (BETHLEHEM, JERUSALEM), descending out of heaven from God." REVELATION 21:10

UNDERLINE THE CORRECT ANSWER:

3. "...And her light was like..." REVELATION 21:11
 - a. A most precious stone
 - b. Like a jasper stone
 - c. Clear as crystal
 - d. All of the above

CIRCLE THE CORRECT WORDS:

4. "Also she had a great and high wall with (TWELVE, TWENTY) gates, and (TWELVE, TWENTY) angels at the gates, and names written on them, which are the names of the (TWELVE, TWENTY) tribes of the children of Israel." REVELATION 21:12
5. "Now the wall of the city had (TWELVE, TWENTY) foundations, and on them were the names of the (TWELVE, TWENTY) apostles of the Lamb." REVELATION 21:14
6. "And the (TWELVE, TWENTY) gates were (TWELVE, TWENTY) pearls: each individual gate was of one pearl. And the street of the city was pure gold, like transparent glass." REVELATION 21:21

TRUE OR FALSE:

7. "But I saw no temple in it, for the Lord God Almighty and the Lamb are its temple." REVELATION 21:22
TRUE OR FALSE
8. "And the city had no need of the sun or of the moon to shine in it, for the glory of God illuminated it, and the Lamb is its light." REVELATION 21:23
TRUE OR FALSE

CIRCLE THE CORRECT WORDS:

9. "And the nations of those who are (SAVED, LOST) shall walk in its light, and the kings of the earth bring their glory and honor into it. Its gates shall not be shut at all by day (there shall be no night there). And they shall bring the glory and the honor of the nations into it." REVELATION 21:24-26
10. "But there shall by no means enter it anything that defiles, or causes an abomination or a lie, but only those who (ARE, ARE NOT) written in the Lamb's Book of Life." REVELATION 21:27

323. THE NEW JERUSALEM

(REVELATION 21:9-27)

P Q O S R E P S A J Q I R S B R I D E B
 H P H R F L U U L H U P L N I D L O G O
 B W O T R Q A G W J U M R O S C S B D V
 B Q L L O R D G O D A L M I G H T Y U B
 E B Y F D N T P R F M P Y T J B J K N T
 F O J J H B Q E J J R S M A M P D K I W
 I G E S K P O C M Q I S T D S F D V A E
 L B R J P T A M S P C N W N L T D M T L
 F T U E P L B K E L L Z E U W V W T N V
 O Y S F P A B J B L B E L O C R C P U E
 K U A H R M R P I B Q Y V F R K N T O G
 O K L B B B J F R R J M E E Y L S H M A
 O I E M J T A G T H U R A V S A P G P T
 B G M H D I H R E E V Y P L T M C I F E
 Q R X O S R B N V A R F O E A B K L L S
 T E G T L I Z C L V F Q S W L S P Z S Z
 Y Y F D E P H D E E J D T T G W T K W O
 O K K L G S P S W N S W L P F I G R U A
 E C Q T N G Y O T Y A M E N M F S O F R
 B D U Q A C J M W M O G S S L E P Y B Y

- | | | | |
|--------------|----------------|-------------------|--------------------|
| ANGELS | GOLD | LAMB'S WIFE | TEMPLE |
| BOOK OF LIFE | HEAVEN | LIGHT | TWELVE APOSTLES |
| BRIDE | HOLY JERUSALEM | LORD GOD ALMIGHTY | TWELVE FOUNDATIONS |
| CRYSTAL | JASPER | MOUNTAIN | TWELVE GATES |
| GOD | LAMB | SPIRIT | TWELVE TRIBES |

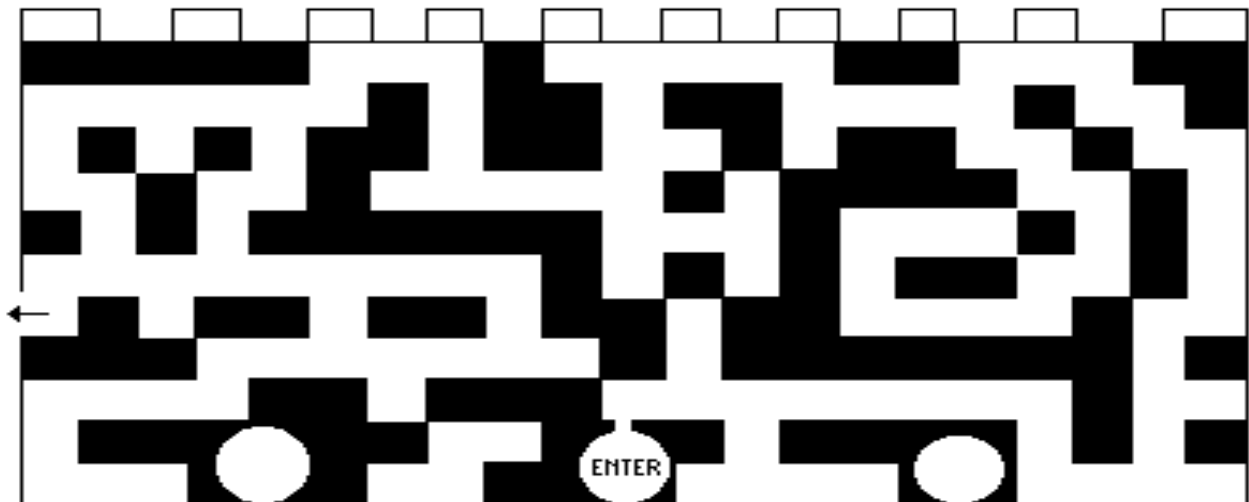

323. THE NEW JERUSALEM

(REVELATION 21:9-27)

MEMORY VERSE:

"Then I, John, saw the holy city, New Jerusalem, coming down out of heaven from God, prepared as a bride adorned for her husband." REVELATION 21:2

FILL IN THE BLANKS:

1. "Then one of the seven angels who had the seven bowls filled with the seven last plagues came to me and talked with me, saying, 'Come, I will show you the bride, the _____ wife.' "
REVELATION 21:9
2. "And he carried me away in the Spirit to a great and high mountain, and showed me the great city, the holy _____, descending out of heaven from God." **REVELATION 21:10**

UNDERLINE THE CORRECT ANSWER:

3. "...And her light was like..." **REVELATION 21:11**
 - a. A most precious stone
 - b. Like a jasper stone
 - c. Clear as crystal
 - d. All of the above

FILL IN THE BLANKS:

4. "Also she had a great and high wall with twelve _____, and twelve _____ at the gates, and names written on them, which are the names of the twelve _____ of the children of Israel."
REVELATION 21:12
5. "Now the wall of the city had twelve _____, and on them were the names of the twelve _____ of the Lamb." **REVELATION 21:14**
6. "And the twelve gates were twelve _____: each individual gate was of one pearl. And the street of the city was pure gold, like transparent glass." **REVELATION 21:21**

TRUE OR FALSE:

7. "But I saw no temple in it, for the Lord God Almighty and the Lamb are its temple." **REVELATION 21:22**
TRUE OR FALSE
8. "And the city had no need of the sun or of the moon to shine in it, for the glory of God illuminated it, and the Lamb is its light." **REVELATION 21:23**
TRUE OR FALSE

FILL IN THE BLANKS:

9. "And the nations of those who are _____ shall walk in its light, and the kings of the earth bring their glory and honor into it. Its gates shall not be shut at all by day (there shall be no night there). And they shall bring the glory and the honor of the nations into it." **REVELATION 21:24-26**
10. "But there shall by no means enter it anything that defiles, or causes an abomination or a lie, but only those who are written in the Lamb's _____." **REVELATION 21:27**

323. THE NEW JERUSALEM (REVELATION 21:9-27)

G Q B R L R E T G U L B Y L A M B A B K L U M Z W S V Q H K
 E L P M E T O H K W M E B R A A U V T P R Q V F Z J S B I P
 G Q T J Y O J K M S E Q C N U F Z T G H F J O A A F D U G U
 T H H Z L J S W P C J A G B K W D P H Q F A V K K R R V A Q
 E V G F H L Z W E T L E M Q Y V C G Q O Z D O Q Z C F D F S
 L Z I J B L N B I P L L U K F B A F Z Z R T F S E R N E W G
 S U L F B A W L Y S D B A L D Q B K T F I I B W A L V H Z B
 V D N E B G I R T S Z S K E Q J F K W R F O J Y H S V M W B
 P F G O B H O Q H M E F N S N C L O I L M B J U V P B U R L
 Z H B R D G V C G S P B I O N A I P V Q C E A F L E W N U L
 S G L I O N M R I D E H I Z I S S C S P R O S I V F J C J O
 M U L Y F W G H M Q B V L R F T H T B L I N P E R Z B A Z U
 B Q N S B B D N L H L E O R T B A N W E R R E O E L E J Q T
 A J B Y Q W O N A E I L Z L Y E V D F S P A R Z R V D K I T
 K V Z D R B T V D N A C I U V W V I N B Z L E E T O C R T Q
 I Q S Y K C C G O P I T G O D D L L M U V B H P Q L V L F B
 Y D V B D R U R G T R J W C Y F T B E U O E Y M E Z H C T W
 T D M O F Y V K D L O I J E O I E W V W A F E R S V H B A N
 F D O J H S N Z R Z N T Z K L F M U E V T L E I W J L B U Z
 Z V N C L T V L O T B B O R I V E Q E L A D T V S P A E C K
 B V G V D A M B L R T O T W B A E N Z S V V X Y L E H B W J
 C D I G I L U I I T B I S K F J Y G U D Q E P M J E B U M T
 S K C W P V O D P B V B T G P T Y R A Z Q Z A U R N W J P C
 L B N H M B E V L S M U I W N L E D Q T U R H P R R R E T W S
 S S E H W H B V E A B K J T I J S Y B O E K Q S O E U Y Q P
 N H B B L C M T L M K B I D Y N Q C U B S S A I Q S G Z Z C
 N I A T N U O M P H C B J L D J K Z W U D E E L U B T O K V
 P P P B G O G L K V E F O C L O Y Y D O E G D N S I D L L H
 M P U B S Y Q C S Y U H B V G I J S Y B B I B D O R J D E D
 N R U U Z K O M N B Z A B S R M P V N T B V I G K B T D Q S

- | | | | |
|--------------|----------------|-------------------|--------------------|
| ANGELS | HOLY JERUSALEM | LORD GOD ALMIGHTY | TWELVE APOSTLES |
| BOOK OF LIFE | JASPER | MOUNTAIN | TWELVE FOUNDATIONS |
| BRIDE | LAMB | PURE GOLD | TWELVE GATES |
| CRYSTAL | LAMB'S WIFE | SPIRIT | TWELVE PEARLS |
| GOD | LIGHT | TEMPLE | TWELVE TRIBES |
| HEAVEN | | | |

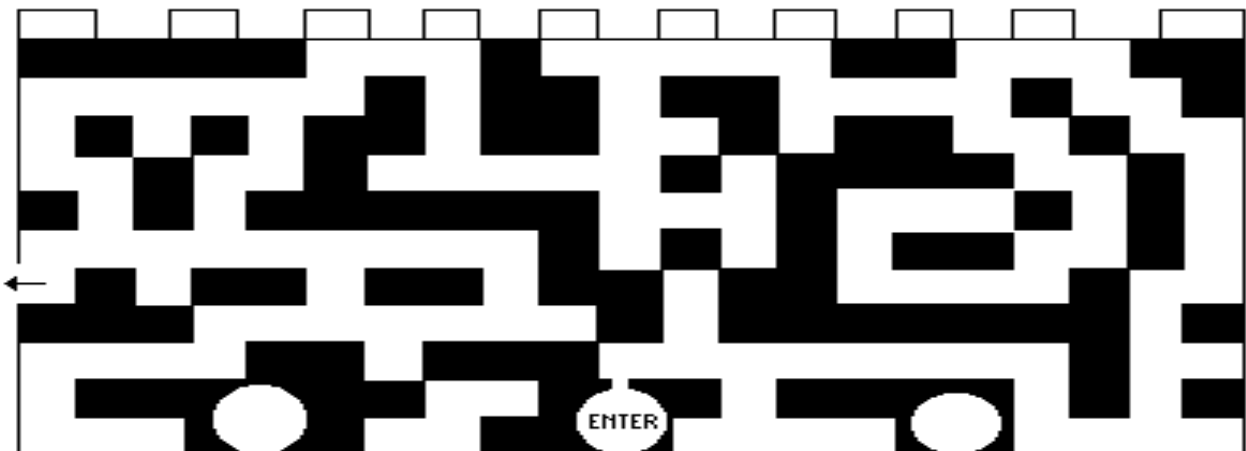

323. THE NEW JERUSALEM

(REVELATION 21:9-27)

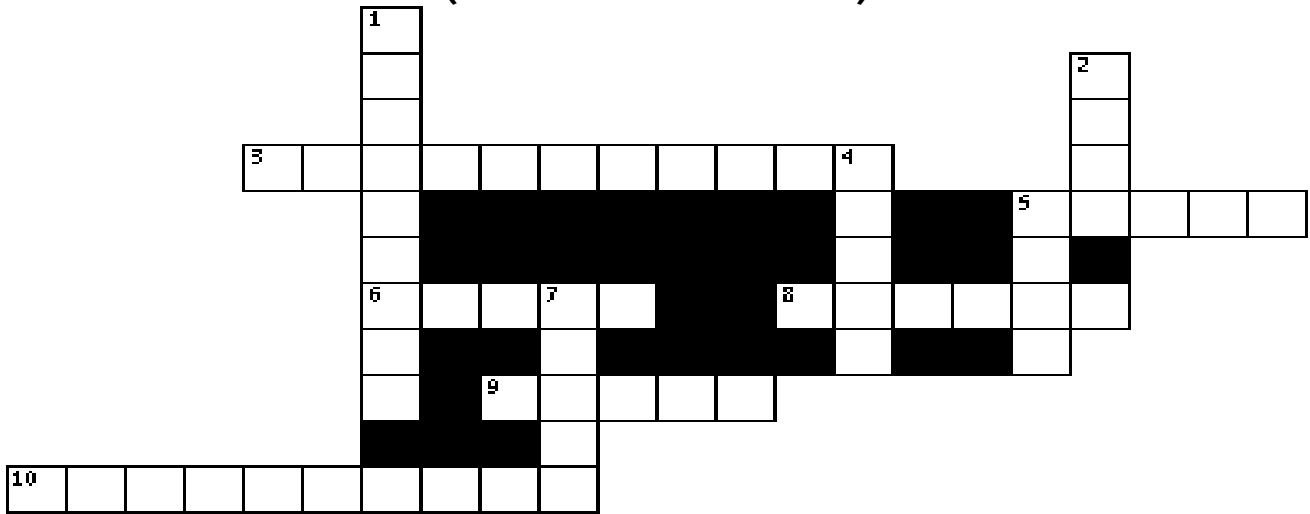

- 7 DOWN "Then I, John, saw the holy city, New Jerusalem, coming down out of heaven from God, prepared as a _____ adorned for her husband." **REVELATION 21:2**
- 6 ACROSS "Then one of the seven angels who had the seven bowls filled with the seven last plagues came to me and talked with me, saying, 'Come, I will show you the bride, the _____ wife.'" **REVELATION 21:9**
- 1 DOWN "And he carried me away in the Spirit to a great and high mountain, and showed me the great city, the holy _____, descending out of heaven from God." **REVELATION 21:10**
- 9 ACROSS "...And her _____ was like a most precious stone, like a jasper stone, clear as crystal." **REVELATION 21:11**
- 2 DOWN "Also she had a great and high _____ with twelve gates, and twelve angels at the gates, and names written on them, which are the names of the twelve tribes of the children of Israel." **REVELATION 21:12**
- 3 ACROSS "Now the wall of the city had twelve _____, and on them were the names of the twelve apostles of the Lamb." **REVELATION 21:14**
- 5 DOWN "...And the street of the city was pure _____, like transparent glass." **REVELATION 21:21**
- 8 ACROSS "But I saw no temple in it, for the Lord God Almighty and the Lamb are its _____." **REVELATION 21:22**
- 5 ACROSS "And the city had no need of the sun or of the moon to shine in it, for the _____ of God illuminated it, and the Lamb is its light." **REVELATION 21:23**
- 4 DOWN "And the nations of those who are _____ shall walk in its light, and the kings of the earth bring their glory and honor into it." **REVELATION 21:24**
- 10 ACROSS "But there shall by no means enter it anything that defiles, or causes an abomination or a lie, but only those who are written in the Lamb's _____ _____ _____." **REVELATION 21:27**

Bible Story 324

THE RIVER OF LIFE

REVELATION 22:1-5

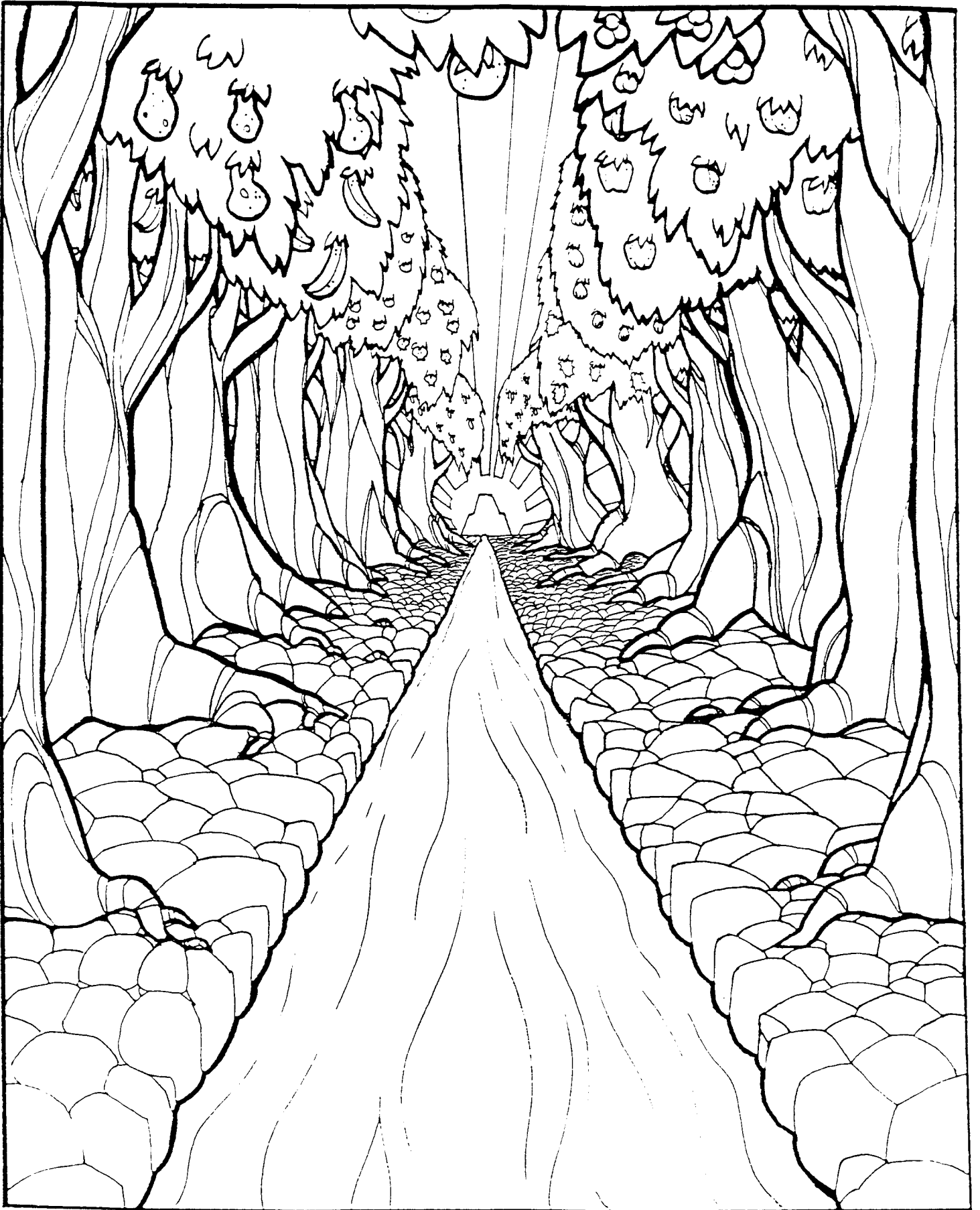

John was shown "a pure river of water of life, clear as crystal,
proceeding from the throne of God and of the Lamb."

REVELATION 22:1

324. THE RIVER OF LIFE

(REVELATION 22:1-5)

MEMORY VERSE:

"And he showed me a pure river of water of life, clear as crystal, proceeding from the throne of God and of the Lamb." REVELATION 22:1

CIRCLE THE CORRECT WORDS:

1. "And he showed me a pure (**GLASS, RIVER**) of water of life, clear as crystal, proceeding from the throne of God and of the Lamb." **REVELATION 22:1**
2. "In the middle of its street, and on either side of the river, was the (**MOUNTAIN, TREE**) of life, which bore twelve fruits, each tree yielding its fruit every month..." **REVELATION 22:2**

TRUE OR FALSE:

3. "...And the leaves of the tree were for the healing of the nations." **REVELATION 22:2**
TRUE OR FALSE

CIRCLE THE CORRECT WORD(S):

4. "And there shall be (**MORE, NO MORE**) curse, but the throne of God and of the Lamb shall be in it, and His servants shall serve Him." **REVELATION 22:3**

TRUE OR FALSE:

5. "They shall see His face, and His name shall be on their foreheads." **REVELATION 22:4**
TRUE OR FALSE
6. There shall be no day there... **REVELATION 22:5**
TRUE OR FALSE
7. "...They need no lamp nor light of the sun, for the Lord God gives them light..."
REVELATION 22:5
TRUE OR FALSE

CIRCLE THE CORRECT WORD:

8. "...And they shall (**REIGN, RUN**) forever and ever." **REVELATION 22:5**

324. THE RIVER OF LIFE

(REVELATION 22:1-5)

L F G V S L L D D E F F U B L
 O O H Z A E T S O C C Z S B B
 R R Q M Y N R B Z G L A D U D
 D E B Q S L E V O O E E F Q V
 G V Z H T I E U E R F R A J Z
 O E T E I G O S B E I F E R R
 D R E A U H F T U I L M S A K
 Q Y R L R T L N T G F C D D E
 L C U I F B I A H N O R A I G
 E Z P N E P F V R B R I E O I
 A Y W G V H E R O T E P H B V
 V S V B L Q Q E N L T Z E E M
 E V B U E O P S E R A V R O V
 S B W W W Z E M A N W Q O N O
 D T M D T F R I V E R Q F R V

CLEAR
 FACE
 FOREHEADS
 FOREVER
 GOD
 HEALING
 LAMB

LEAVES
 LIGHT
 LORD GOD
 NAME
 PURE
 REIGN
 RIVER

SERVE
 SERVANTS
 THRONE
 TREE OF LIFE
 TWELVE FRUITS
 WATER OF LIFE

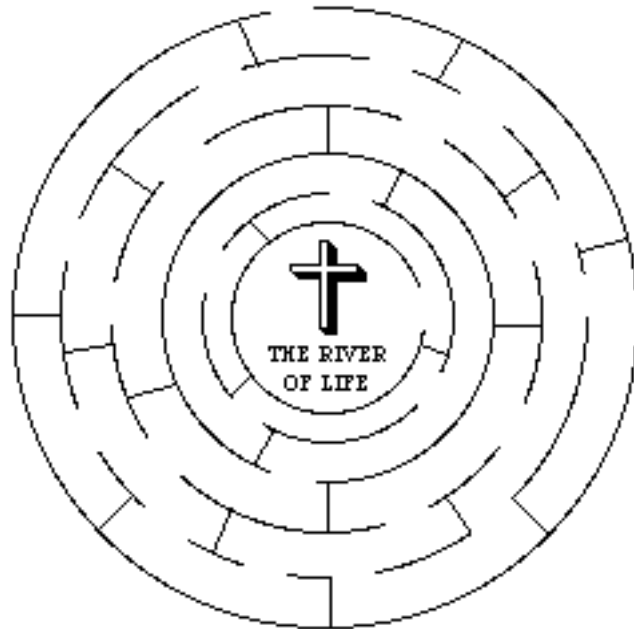

324. THE RIVER OF LIFE

(REVELATION 22:1-5)

MEMORY VERSE:

"And he showed me a pure river of water of life, clear as crystal, proceeding from the throne of God and of the Lamb." REVELATION 22:1

FILL IN THE BLANKS:

1. "And he showed me a pure _____ of water of _____, clear as crystal, proceeding from the throne of God and of the Lamb." **REVELATION 22:1**
2. "In the middle of its street, and on either side of the river, was the _____ of _____, which bore twelve fruits, each tree yielding its fruit every month..." **REVELATION 22:2**

TRUE OR FALSE:

3. "...And the leaves of the tree were for the healing of the nations." **REVELATION 22:2**
TRUE OR FALSE

FILL IN THE BLANK:

4. "And there shall be no more _____, but the throne of God and of the Lamb shall be in it, and His servants shall serve Him." **REVELATION 22:3**

TRUE OR FALSE:

5. "They shall see His face, and His name shall be on their foreheads." **REVELATION 22:4**
TRUE OR FALSE
6. There shall be no day there... **REVELATION 22:5**
TRUE OR FALSE
7. "...They need no lamp nor light of the sun, for the Lord God gives them light..."
REVELATION 22:5
TRUE OR FALSE

FILL IN THE BLANK:

8. "...And they shall _____ forever and ever." **REVELATION 22:5**

324. THE RIVER OF LIFE

(REVELATION 22:1-5)

R M E W Y B P Z C U R D E Q J I B A C C V Z Q K U
 L Z D V D K U I C A W D O G D R O L L E B Z A A T
 B D C Z A G U D E U N O L P N V B U P Z J L L H H
 H C C Z U L R L B E O F I Y W V M I I K P C G T R
 F V L M Q G C U T H A W Z Z E O M C I B A J H F O
 D E G M C O D K E B R D J I Y Y E W W V R G I A N
 D K G M N D Y L J K B U Y N N K O Q S Q I D C D E
 V B S I L O E V R E S I K Q U G Z A E L B F T B N
 D Z B T B M M P U R E B B V Z O O R V W L B T B B
 M B V B I L D R M F T T F A U E J R A B E V E Q U
 V O S O C U B T H S W O Z E I N D W E B Q E A P V
 P R S J E T R A O Q B E M F R U E Y L R U F P J W
 T B F U O T B F P V M A S I V Z F M F T N I C Z E
 I B A F W J Y L E A A Z W L B P O I S A H L G J M
 H T V O S T E S N V N H N F M H R D R M N F G D Y
 N C S R P E A K D H L Q O O A S E V N M H O R D C
 N N W E Y H R J E K P E U R L P V E C Q E E B P K
 S P A H V H O V C P M W W E B J E I R S J E S S S
 K O W E Z G I B A W Y I H T G E R W L R P R N V R
 Y J W A Y J Y R K N H Y G A N C B A V S L T W D E
 L T Z D S J W Q W G T M F W I A Y D F F U Y Z S I
 N Z O S S H Y C C Q C S B B L F J J C C C R S U G
 O D B B O V M O W V G H R F A Y T T K Q K H W B N
 R I V E R F R C O Y D W T R E V W B B E G W R J G
 H E A O I O F G E H J N F I H M H W D S S M Z M C

CLEAR
 FACE
 FOREHEADS
 FOREVER
 GOD
 HEALING
 LAMB

LEAVES
 LIGHT
 LORD GOD
 NAME
 PURE
 REIGN
 RIVER

SERVE
 SERVANTS
 THRONE
 TREE OF LIFE
 TWELVE FRUITS
 WATER OF LIFE

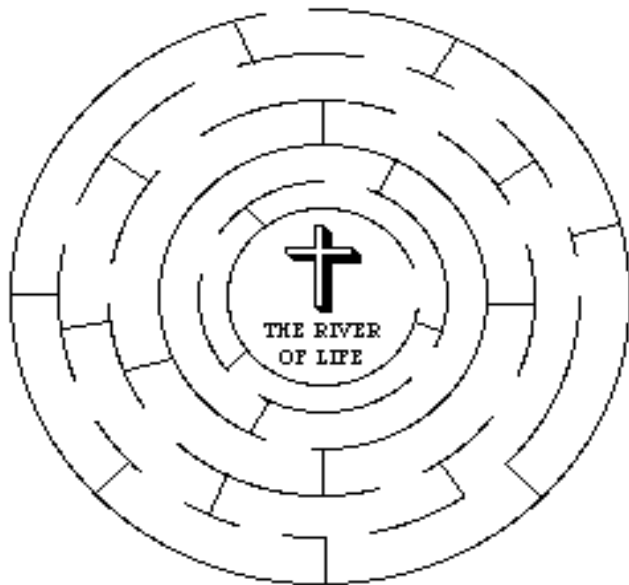

324. THE RIVER OF LIFE

(REVELATION 22:1-5)

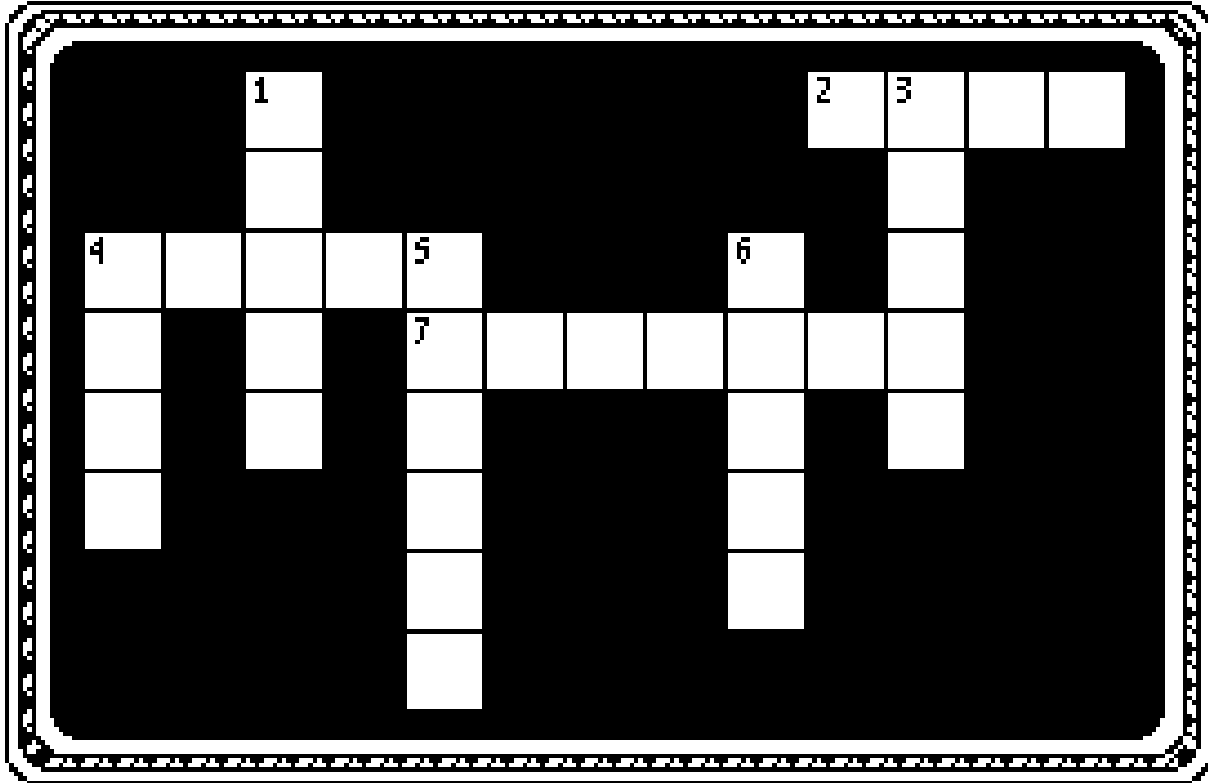

- 6 DOWN "And he showed me a pure _____ of water of life, clear as crystal, proceeding from the throne of God and of the Lamb." **REVELATION 22:1**
- 2 ACROSS "In the middle of its street, and on either side of the river, was the _____ of life, which bore twelve fruits, each tree yielding its fruit every month..." **REVELATION 22:2**
- 7 ACROSS "...And the leaves of the tree were for the _____ of the nations." **REVELATION 22:2**
- 5 DOWN "And there shall be no more curse, but the _____ of God and of the Lamb shall be in it, and His servants shall serve Him." **REVELATION 22:3**
- 4 DOWN "They shall see His face, and His _____ shall be on their foreheads." **REVELATION 22:4**
- 4 ACROSS "There shall be no _____ there..." **REVELATION 22:5**
- 1 DOWN "...They need no lamp nor light of the sun, for the Lord God gives them _____..." **REVELATION 22:5**
- 3 ACROSS "...And they shall _____ forever and ever." **REVELATION 22:5**

Bible Story 325

**I COME
QUICKLY**

REVELATION 22:6-17, 20-21



John is told, "These words are faithful and true."
REVELATION 22:6

325. I COME QUICKLY

(REVELATION 22:6-17, 20-21)

MEMORY VERSE:

"And the Spirit and the bride say, 'Come!' And let him who hears say, 'Come!' And let him who thirsts come. Whoever desires, let him take the water of life freely."
REVELATION 22:17

TRUE OR FALSE:

1. "Behold, I am coming quickly! Blessed is he who keeps the words of the prophecy of this book." **REVELATION 22:7**

TRUE OR FALSE

FILL IN THE BLANKS:

2. "Now I, John, saw and heard these things. And when I heard and saw, I fell down to worship before the feet of the angel who showed me these things. Then he said to me, 'See that you do not do that. For I am your fellow servant, and of your brethren the prophets, and of those who keep the words of this book. _____.'" **REVELATION 22:8-9**

CIRCLE THE CORRECT WORDS:

3. "And he said to me, 'Do not (**SEAL**, **STEAL**) the words of the prophecy of this book, for the time is at hand.'" **REVELATION 22:10**
4. "And behold, I am coming (**SLOWLY**, **QUICKLY**), and My reward is with Me, to give to every one according to his work." **REVELATION 22:12**

TRUE OR FALSE:

5. "Blessed are those who do His commandments, that they may have the right to the tree of life, and may enter through the gates into the city." **REVELATION 22:14**

TRUE OR FALSE

CIRCLE THE CORRECT WORDS:

6. "And the Spirit and the bride say, '(**COME!**, **HELLO**)' And let him who hears say, '(**COME!**, **HELLO**)' And let him who thirsts come. And whoever desires, let him take the water of life freely." **REVELATION 22:17**

"THE GRACE OF OUR LORD JESUS CHRIST BE WITH YOU ALL."
REVELATION 22:21

325. I COME QUICKLY

(REVELATION 22:6-17, 20-21)

W B Z Z T A S O Y N D E S S E L B O P A
 Z O Z P S B P R T W D Y H P T W F Q L V
 Y T R Z A C I C R E R K M W H F R P M A
 E D E S W Q R C E H A Z U E S K H A B O
 K P S B H K I U E Z W U J P J A B F R W
 G T G F I I T B O J E M R T A G E W Z E
 Z C Y I L H P R F Q R I H N M Q G E F Y
 S P M R V C Y B L B N P D F U N I J A C
 D N B S U D L L I G Z O W O N G N N I E
 O B O T A O K E F M M G Q R N H N Q T H
 G I L A G G C G E E P K J U E W I A H P
 D V F N O H I N G G A L W A D Z N B F O
 R G W D J L U A V B E W L M I G G M U R
 O U U L D U Q P P N C B B Q R V A M L P
 L K U A E A E S L E A K E P B K N J F T
 S J Y S Q B M E A M R N H B R C D L I E
 B D O T W G O T G A G I O T S U E F A P
 E W R F D D C A U H K I L O C E N U B C
 W S L O U V I G E P W C D O R T D Z R V
 G F P P W Z Y I S N O J Q R G N G A N T

ALPHA AND OMEGA
 AMEN
 ANGEL
 BEGINNING AND END
 BEHOLD
 BLESSED

BRIDE
 FAITHFUL
 FIRST AND LAST
 GATES
 GOD
 GRACE

I COME QUICKLY
 LORD GOD
 OFFSPRING
 PLAGUES
 PROPHECY
 REWARD

ROOT
 SPIRIT
 TREE OF LIFE
 TRUE
 WORDS
 WORSHIP



"AND BEHOLD, I AM COMING QUICKLY"

325. I COME QUICKLY

(REVELATION 22:6-17, 20-21)

MEMORY VERSE:

"And the Spirit and the bride say, 'Come!' And let him who hears say, 'Come!' And let him who thirsts come. Whoever desires, let him take the water of life freely."
REVELATION 22:17

TRUE OR FALSE:

1. "Behold, I am coming quickly! Blessed is he who keeps the words of the prophecy of this book." REVELATION 22:7

TRUE OR FALSE

FILL IN THE BLANKS:

2. "Now I, John, saw and heard these things. And when I heard and saw, I fell down to worship before the feet of the angel who showed me these things. Then he said to me, 'See that you do not do that. For I am your fellow servant, and of your brethren the prophets, and of those who keep the words of this book. _____.'" REVELATION 22:8-9
3. "And he said to me, 'Do not _____ the words of the prophecy of this book, for the time is at hand.'" REVELATION 22:10
4. "And behold, I am coming _____, and My reward is with Me, to give to every one according to his work." REVELATION 22:12

TRUE OR FALSE:

5. "Blessed are those who do His commandments, that they may have the right to the tree of life, and may enter through the gates into the city." REVELATION 22:14

TRUE OR FALSE

FILL IN THE BLANKS:

6. "And the Spirit and the bride say, '_____' And let him who hears say, '_____' And let him who thirsts come. And whoever desires, let him take the water of life freely."
REVELATION 22:17

**"THE GRACE OF OUR LORD JESUS CHRIST BE WITH YOU ALL."
REVELATION 22:21**

325. I COME QUICKLY

(REVELATION 22:6-17, 20-21)

Y L Z N E B L O G E S E U I V A Z P T L C J O K W U P V K I
T O O R O D A T R I M U K J T F D G W Q R A V Q Z S E H R T
U S D G R O G C K P H Z B R S W C F V P I D O S A O N H L F
W V O B I F H U Z L V B U B U V A K B S P I F W K K R A C T
D P G L Y X G V L E Y E B B K B B K W B Z O B Y Z S B H B A
O Z U L S Q N N B P B E F R Y Q F O M U V N J U E J I B X U
K S D N Y R W V A K L Q A X F J L C V D E B Y D R A W E R C
J M F B D K B M G Y M D Y Q D C I T Z M L E T F T I R I P S
Q B H Z Y D W U E S C A N K Q A H N A Z U O A I A F R E B M
B A G S B F B O M N E E B E N S V B Q O F N N E H R B U U P
Z K U V O H V B O U J L H L D B M U E B H R G O V C V D J W
P I Q M J L B M D W L B C P N N E Q B F T L E Z L R S J Y Q
Q Y J O C D H G N S D F M E O W A D U S I B L E V L D T Z Z
L T V N V I C Q A C Z H U S F R Y G E U A L B R R S R Q D K
A F Q G G P O O A T P V A Z Y D P U N O F D F I E P F B D Q
L Z D I W W Y T H P E L K R V I G Y W I Q V G O R E N U H K
L B D C H O K H P M B E O L Y A F C D B N R H Y E F V V I P
M C D N H R E K L S L L I R L A P I Y T A N L D T E V D G U
S S V E B D O W A D I C L P D I Y Z R C Q K I Y L Z R E A Q
O L V B B S J W I Q A J O U H G S Y E S C Z Q G Q O G T F S
A S D P B M S B V H I I Z S B J O S N I T R A M E N H H W G
L N K U U W Z L V E R T R C F T Q D U L U A E S I B B E Z B
K P W U L L N R T N O O I R P L K Q K R S K N R S L W M B B
N M S R Y G W Q L P W B J K N N E V P F D E P D W V J U W L
M N H J L S I C C T N I Z G I M Y B H F E S D I L O B N R L
G Q P Z H Z O R M L T G T W O J J T Q Z F G B L S A E C U O
E D I R B R V H G Z V A T C D O P G O F B I I N J L S A J U
G Q P F B O M N K T B T I T L I A H O R B V Z D R Z D T Z T
T H R J B J G N M T K E I D G M V Q Z F B M F G Q J C J Q T
E V B F B L D V P B C S J C R U T Z F M Q V A D E S S E L B

ALPHA AND OMEGA
AMEN
ANGEL
BEGINNING AND END
BEHOLD
BLESSED

BRIDE
FAITHFUL
FIRST AND LAST
GATES
GOD
GRACE

I COME QUICKLY
LORD GOD
OFFSPRING
PLAGUES
PROPHECY
REWARD

ROOT
SPIRIT
TREE OF LIFE
TRUE
WORDS
WORSHIP



"AND BEHOLD, I AM COMING QUICKLY"

325. I COME QUICKLY

(REVELATION 22:6-17, 20-21)

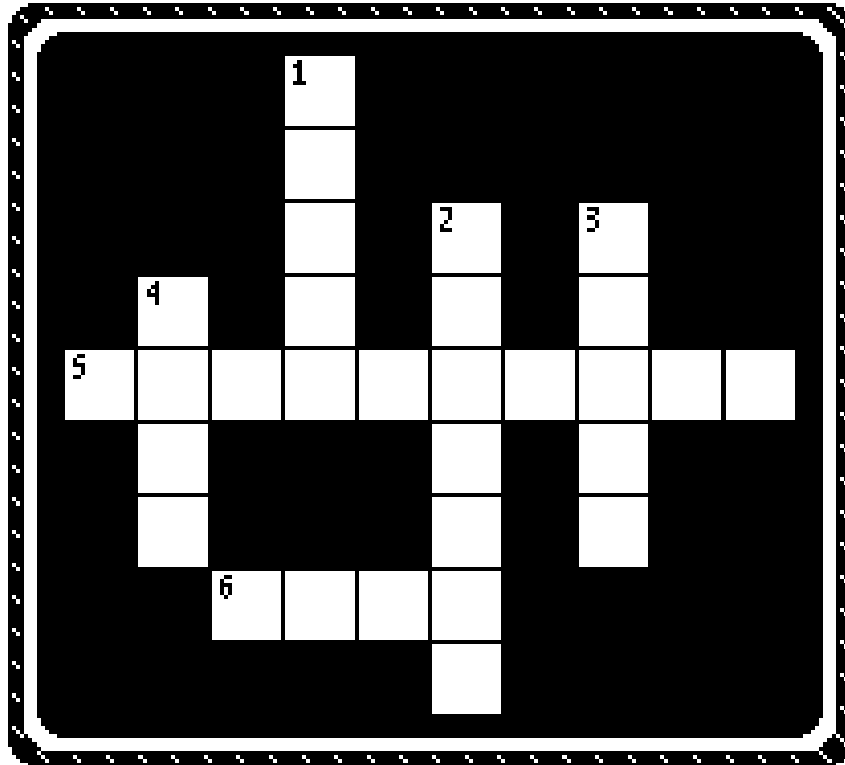

- 1 DOWN "Behold, I am coming quickly! Blessed is he who _____ the words of the prophecy of this book."
REVELATION 22:7
- 5 ACROSS "Now I, John, saw and heard these things. And when I heard and saw, I fell down to worship before the feet of the angel who showed me these things. Then he said to me, 'See that you do not do that. For I am your fellow servant, and of your brethren the prophets, and of those who keep the words of this book. _____.'" **REVELATION 22:8-9**
- 6 ACROSS "And he said to me, 'Do not _____ the words of the prophecy of this book, for the time is at hand.'" **REVELATION 22:10**
- 2 DOWN "And behold, I am coming _____, and My reward is with Me, to give to every one according to his work." **REVELATION 22:12**
- 3 DOWN "Blessed are those who do His commandments, that they may have the _____ to the tree of life, and may enter through the gates into the city." **REVELATION 22:14**
- 4 DOWN "And the Spirit and the bride say, '_____!' And let him who hears say, 'Come!' And let him who thirsts come. And whoever desires, let him take the water of life freely." **REVELATION 22:17**

***"THE GRACE OF OUR LORD JESUS CHRIST BE WITH YOU ALL."
REVELATION 22:21***